

RECTIFIER DIODE

AR747LT

Repetitive voltage up to **2600 V**
Mean forward current **6909 A**
Surge current **70 kA**

FINAL SPECIFICATION

Mar. 17 - Issue: 3

Symbol	Characteristic	Conditions	T _j [°C]	Value	Unit
BLOCKING					
V _{RRM}	Repetitive peak reverse voltage		175	2600	V
V _{RSM}	Non-repetitive peak reverse voltage		175	2700	V
I _{RRM}	Repetitive peak reverse current	V=VRRM	175	150	mA
CONDUCTING					
I _{F(AV)}	Mean forward current	180° sin, 50 Hz, Th=55°C, double side cooled		6909	A
I _{F(AV)}	Mean forward current	180° sin, 50 Hz, Tc=85°C, double side cooled		6692	A
I _{FSM}	Surge forward current	Sine wave, 10 ms without reverse voltage	175	70	kA
I ² t	I ² t			24500 x 10 ³	A ² s
V _{FM}	Forward voltage	Forward current = 3000 A	25	1,01	V
V _{F(TO)}	Threshold voltage		175	0,72	V
r _F	Forward slope resistance		175	0,065	mohm
SWITCHING					
t _{rr}	Reverse recovery time		175		μs
Q _{rr}	Reverse recovery charge				μC
I _{rr}	Peak reverse recovery current				A
MOUNTING					
R _{th(j-h)}	Thermal impedance, DC	Junction to heatsink, double side cooled		9,5	°C/kW
R _{th(c-h)}	Thermal impedance	Case to heatsink, double side cooled		2,0	°C/kW
T _j	Operating junction temperature			-30 / 175	°C
F	Mounting force			046 / 054	kN
	Mass			1150	g

ORDERING INFORMATION : AR747LT S 26

standard specification VRRM/100

DISSIPATION CHARACTERISTICS

SQUARE WAVE

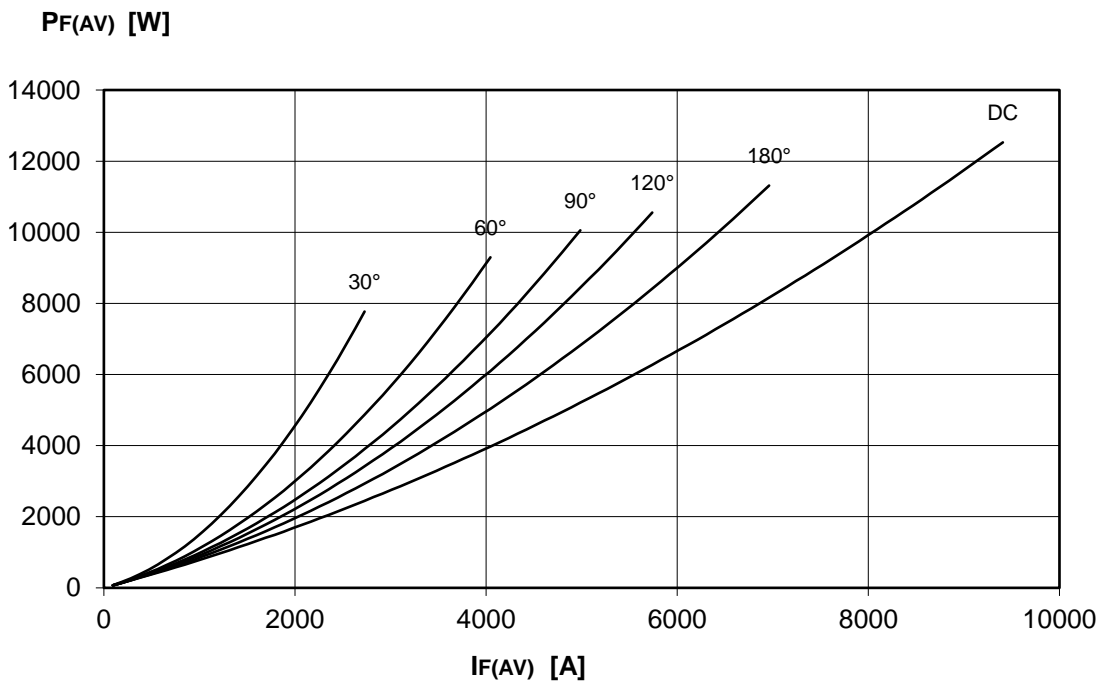
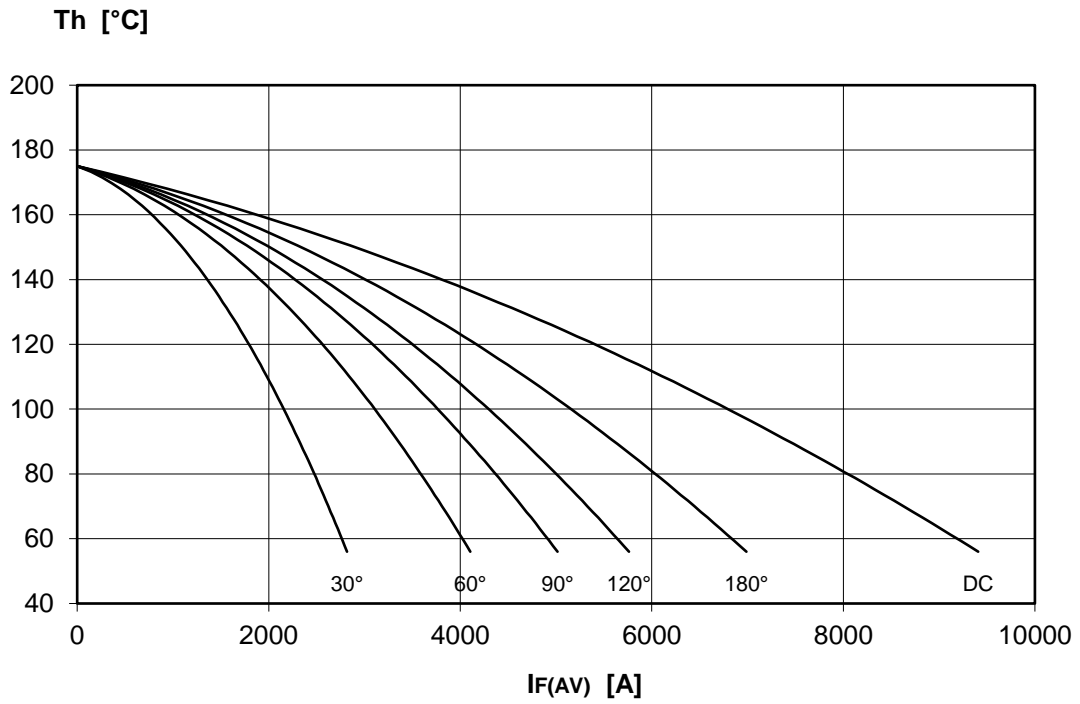

DISSIPATION CHARACTERISTICS

SINE WAVE

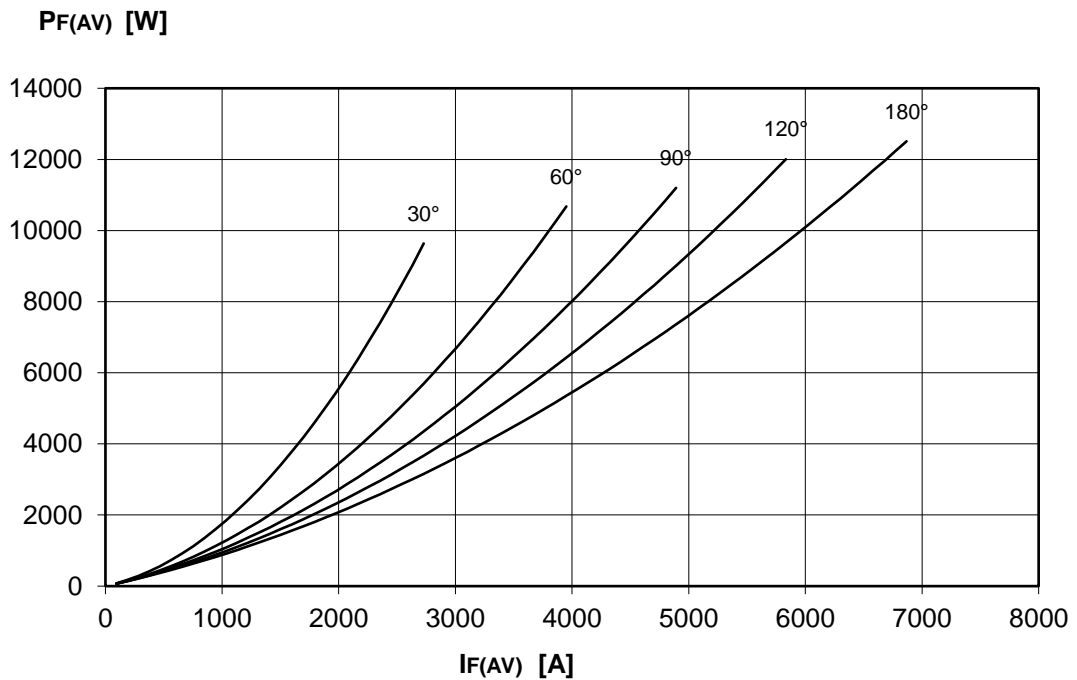
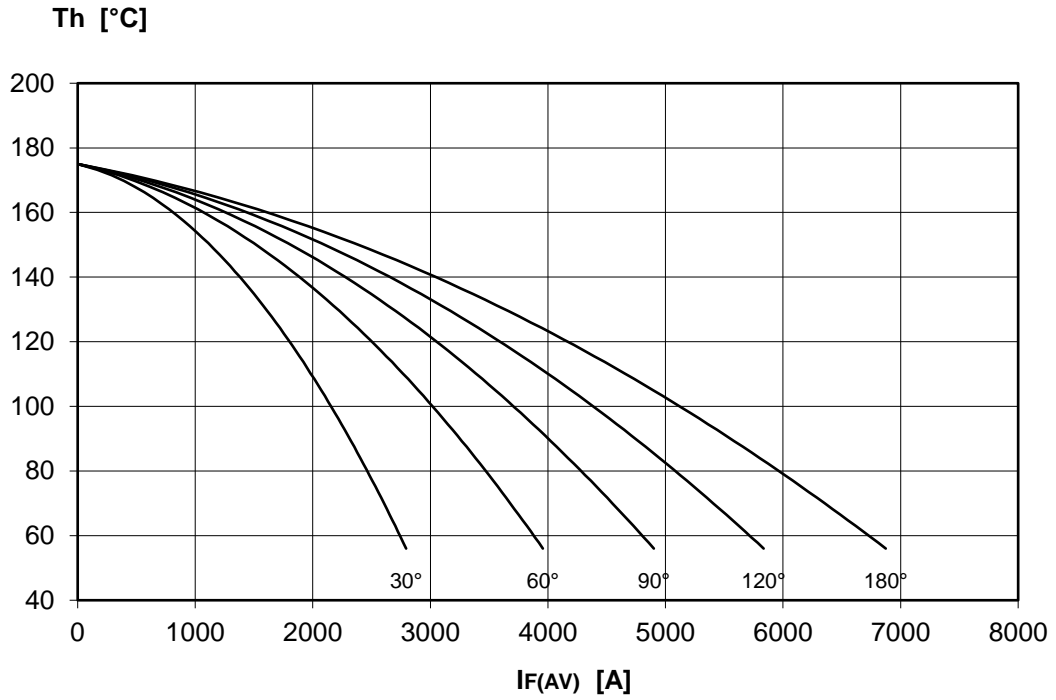

AR747LT RECTIFIER DIODE



FINAL SPECIFICATION Mar. 17 - Issue: 3

FORWARD CHARACTERISTIC
T_J = 175 °C

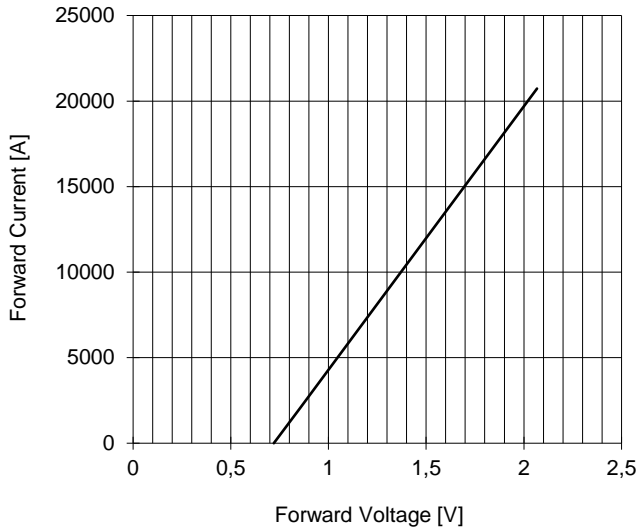

SURGE CHARACTERISTIC
T_J = 175 °C

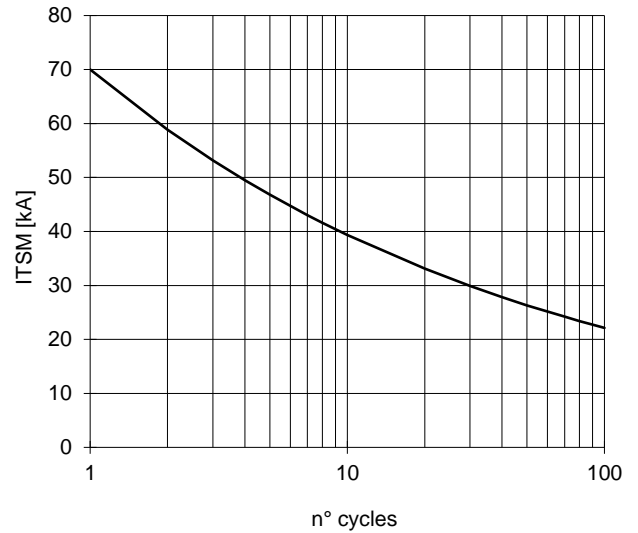

TRANSIENT THERMAL IMPEDANCE
DOUBLE SIDE COOLED

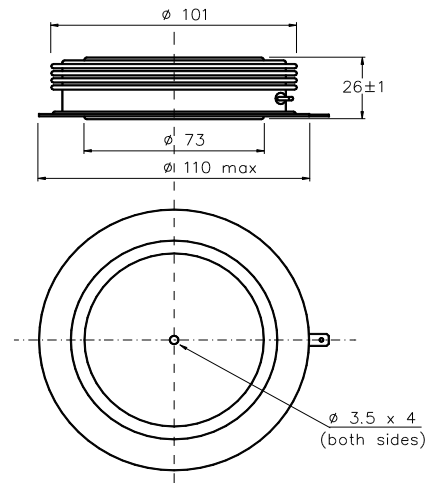
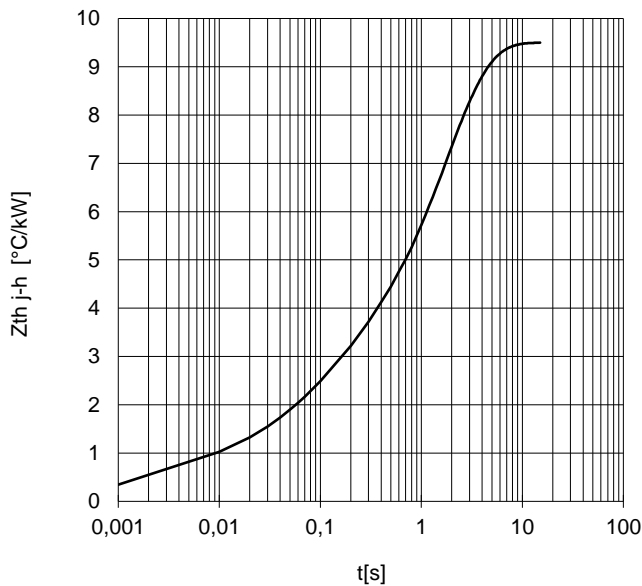

Dimensions
in mm



All the characteristics given in this data sheet are guaranteed only with uniform clamping force, cleaned and lubricated heatsink, surfaces with flatness < .03 mm and roughness < 2 μm.

In the interest of product improvement POSEICO SpA reserves the right to change any data given in this data sheet at any time without previous notice.

If not stated otherwise the maximum value of ratings (symbols over shaded background) and characteristics is reported.

Distributed by

