

BIPOLAR ANALOG INTEGRATED CIRCUIT

μ PC1678G

5 V-BIAS, +17.5 dBm OUTPUT, 2.0 GHz WIDEBAND Si MMIC AMPLIFIER

DESCRIPTION

The μ PC1678G is a silicon monolithic integrated circuit designed as medium output power amplifier for high frequency system applications. Due to +17.5 dBm TYP. output at 2 GHz, this IC is recommendable for transmitter stage amplifier of L BAND wireless communication systems. This IC is packaged in 8-pin plastic SOP.

This IC is manufactured using NEC's 20 GHz fr NESAT™IV silicon bipolar process. This process uses silicon nitride passivation film and gold electrodes. These materials can protect chip surface from external pollution and prevent corrosion/migration. Thus, this IC has excellent performance, uniformity and reliability.

FEATURES

- Supply voltage : $V_{CC} = 4.5$ to 5.5 V
- Saturated output power : $P_{O(sat)} = +17.5$ dBm TYP. @ $f = 500$ MHz with external inductor
- Wideband response : $f_u = 2.0$ GHz TYP. @ 3 dB bandwidth
- Power gain : $G_P = 23$ dB TYP. @ $f = 500$ MHz
- Isolation : $ISL = 35$ dB TYP. @ $f = 500$ MHz

APPLICATIONS

- PA driver for high frequency system.

ORDERING INFORMATION

Part Number	Package	Marking	Supplying Form
μ PC1678G	8-pin plastic SOP (225 mil)	1678	Plastic magazine case
μ PC1678G -E1			Embossed tape 12 mm wide. 1 pin is tape pull-out direction. Qty 2.5 kp/reel.
μ PC1678G -E2			Embossed tape 12 mm wide. 1 pin is tape roll-in direction. Qty 2.5 kp/reel.

Remark To order evaluation samples, please contact your local NEC sales office.
(Part number for sample order: μ PC1678G)

Caution Electro-static sensitive devices

The information in this document is subject to change without notice. Before using this document, please confirm that this is the latest version.
Not all devices/types available in every country. Please check with local NEC representative for availability and additional information.

PIN CONNECTIONS

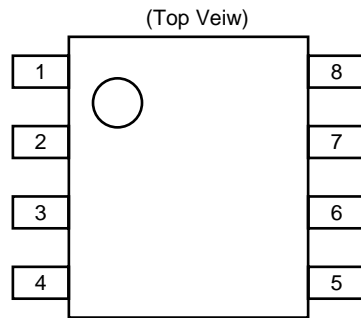

Pin No.	Pin Name
1	INPUT
2	GND
3	GND
4	GND
5	OUTPUT
6	GND
7	GND
8	V _{CC}

PRODUCT LINE-UP (T_A = +25 °C, V_{CC} = V_{out} = 5.0 V, Z_L = Z_S = 50 Ω)

Part Number	f _u (GHz)	P _{O(sat)} (dBm)	G _p (dB)	NF (dB)	I _{CC} (mA)	Package
μPC1678G	2.0	+17.5	23	6.0	49	8-pin plastic SOP (225 mil)
μPC1678GV	2.0	+17.5	23	6.0	49	8-pin plastic SSOP (175 mil)

Remark Typical performance. Please refer to **ELECTRICAL CHARACTERISTICS** in detail.

SYSTEM APPLICATION EXAMPLE

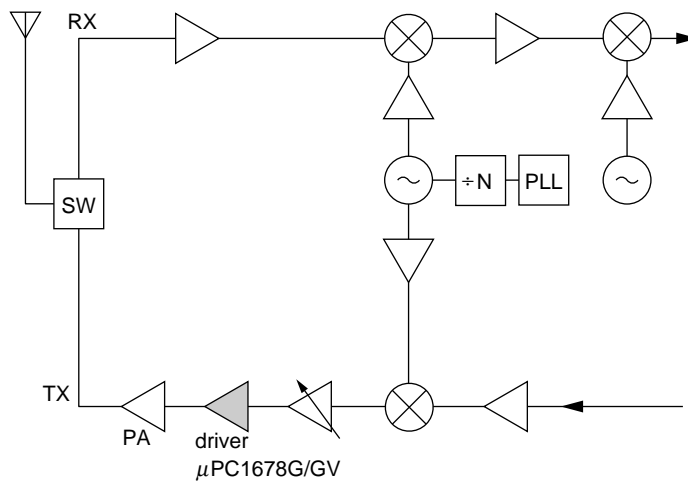

PIN EXPLANATION

Pin No.	Pin Name	Applied Voltage (V)	Function and Applications	Internal Equivalent Circuit
1	INPUT	–	Signal input pin. A internal matching circuit, configured with resistors, enables 50 Ω connection over a wide band. A multi-negative feedback circuit is designed to cancel the deviations of h_{FE} and resistance. This pin must be coupled to signal source with capacitor for DC cut.	<p>2, 3, 4, 6 and 7 are shorted by a lead frame.</p>
2 3 4 6 7	GND	0	Ground pin. This pin should be connected to system ground with minimum inductance. Ground pattern on the board should be formed as widely as possible. All the ground pins must be connected together with wide ground pattern to decrease impedance difference.	
5	OUTPUT	Voltage as same as V_{CC} through external inductor	Signal output pin. The inductor must be attached between V_{CC} and output pins to supply current to the internal output transistors.	
8	V_{CC}	4.5 to 5.5	Power supply pin, which biases the internal input transistors. This pin should be externally equipped with bypass capacitor to minimize its impedance.	

ABSOLUTE MAXIMUM RATINGS

Parameter	Symbol	Conditions	Rating	Unit
Supply Voltage	V _{CC}	T _A = +25 °C, pin 5 and 8	6	V
★ Power Dissipation	P _D	Mounted on double copper clad 50 × 50 × 1.6 mm epoxy glass PWB (T _A = +85 °C)	360	mW
Operating Ambient Temperature	T _A		-45 to +85	°C
Storage Temperature	T _{stg}		-55 to +150	°C
Input Power	P _{in}	T _A = +25 °C	+10	dBm

RECOMMENDED OPERATING RANGE

Parameter	Symbol	MIN.	TYP.	MAX.	Unit	Notice
Supply Voltage	V _{CC}	4.5	5.0	5.5	V	The same voltage should be applied to pin 5 and 8
Operating Ambient Temperature	T _A	-45	+25	+85	°C	

ELECTRICAL CHARACTERISTICS (T_A = +25 °C, V_{CC} = V_{out} = 5.0 V, Z_S = Z_L = 50 Ω)

Parameter	Symbol	Conditions	MIN.	TYP.	MAX.	Unit
Circuit Current	I _{CC}	No signal	40.0	49.0	60.0	mA
Power Gain	G _P	f = 500 MHz	21	23	25	dB
Noise Figure	NF	f = 500 MHz	-	6.0	8.0	dB
Upper Limit Operating Frequency	f _u	3 dB down below the gain at 0.1 GHz	1.7	2.0	-	GHz
Isolation	ISL	f = 500 MHz	30	35	-	dB
Input Return Loss	RL _{in}	f = 500 MHz	11	14	-	dB
Output Return Loss	RL _{out}	f = 500 MHz	1	4	-	dB
Saturated Output Power	P _{O(sat)}	f = 500 MHz	+15.5	+17.5	-	dBm

TEST CIRCUIT

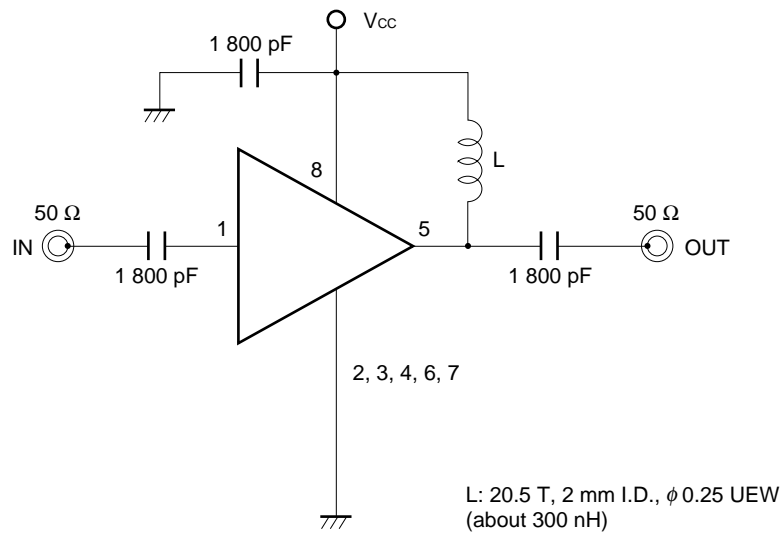

INDUCTOR FOR THE OUTPUT PIN

The internal output transistor of this IC consumes 30 mA, to output medium power. To supply current for output transistor, connect an inductor between the Vcc pin (pin 8) and output pin (pin 5).

The inductor has both DC and AC effects. In terms of DC, the inductor biases the output transistor with minimum voltage drop to output enable high level. In terms of AC, the inductor make output-port impedance higher to get enough gain. In this case, large inductance and Q is suitable.

CAPACITORS FOR THE Vcc, INPUT AND OUTPUT PINS

Capacitors of 1 800 pF are recommendable as the bypass capacitor for the Vcc pin and the coupling capacitors for the input and output pins.

The bypass capacitor connected to the Vcc pin is used to minimize ground impedance of Vcc pin. So, stable bias can be supplied against Vcc fluctuation.

The coupling capacitors, connected to the input and output pins, are used to cut the DC and minimize RF serial impedance. Their capacitance are therefore selected as lower impedance against a 50 Ω load. The capacitors thus perform as high pass filters, suppressing low frequencies to DC.

To obtain a flat gain from 100 MHz upwards, 1 800 pF capacitors are used in the test circuit. In the case of under 100 MHz operation, increase the value of coupling capacitor such as 10 000 pF. Because the coupling capacitors are determined by equation, $C = 1/(2 \pi Rfc)$.

ILLUSTRATION OF THE TEST CIRCUIT ASSEMBLED ON EVALUATION BOARD

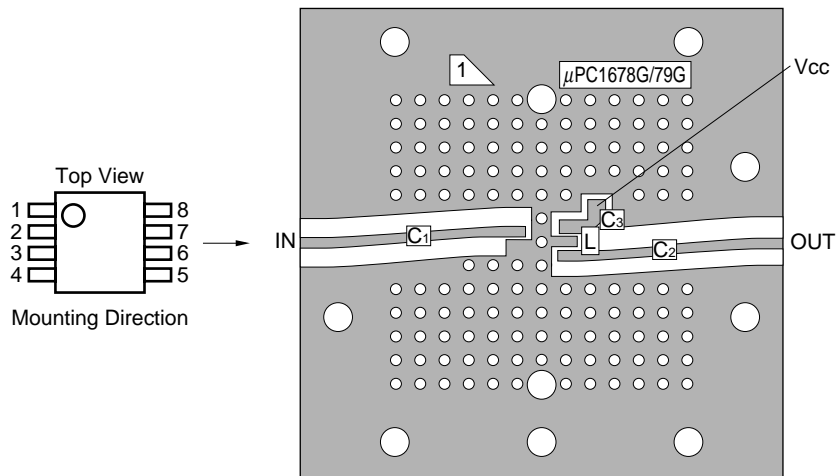

COMPONENT LIST

	Value
C ₁ to C ₃	1 800 pF
L	300 nH

Notes

1. 50 × 50 × 0.4 mm double sided copper clad polyimide board.
2. Back side: GND pattern
3. Solder plated on pattern
4. ○ ○ : Through holes

For more information on the use of this IC, refer to the following application note: USAGE AND APPLICATION OF SILICON MEDIUM-POWER HIGH-FREQUENCY AMPLIFIER MMIC (P12152E).

TYPICAL CHARACTERISTICS (Unless otherwise specified, $T_A = +25\text{ }^\circ\text{C}$)

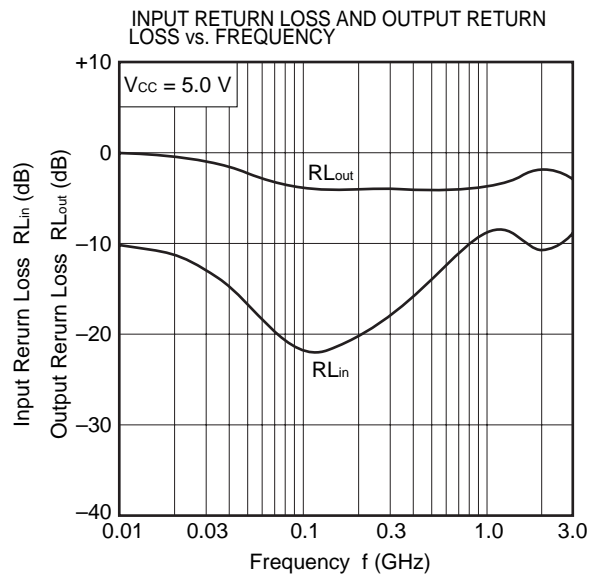
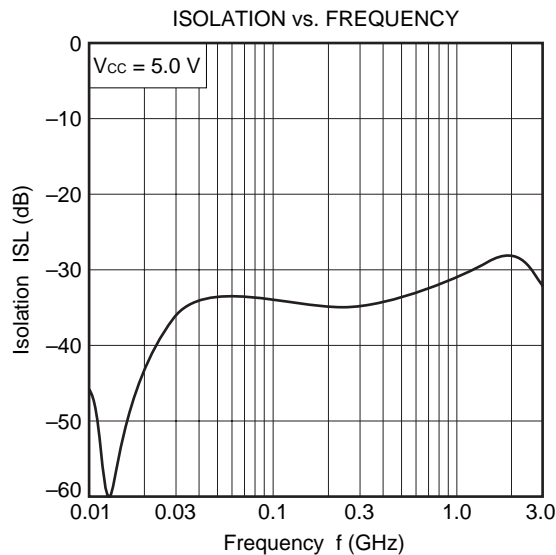
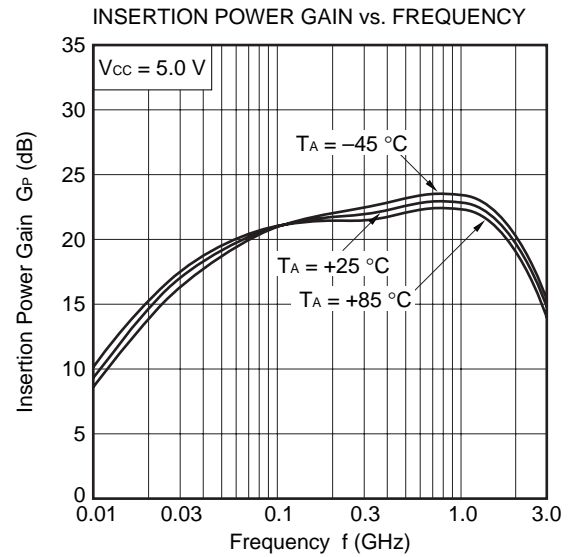
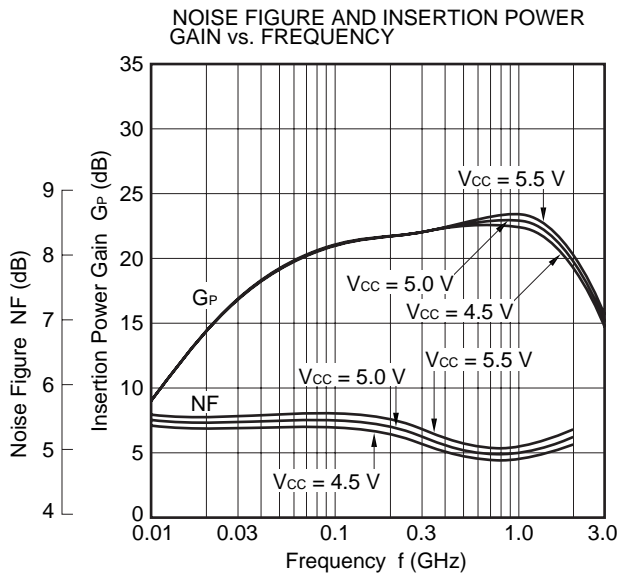
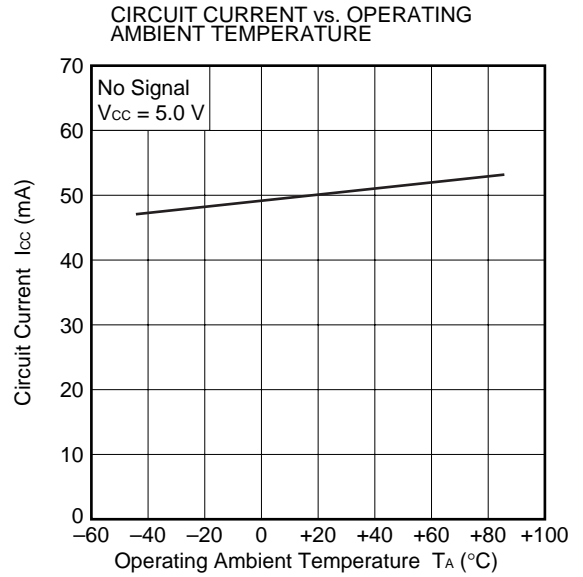
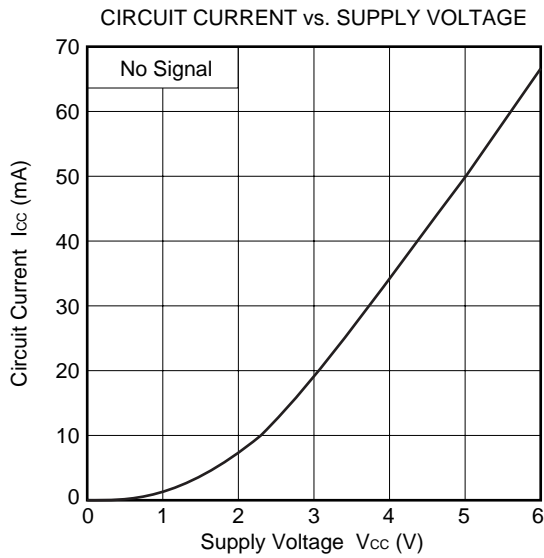

OUTPUT POWER vs. INPUT POWER

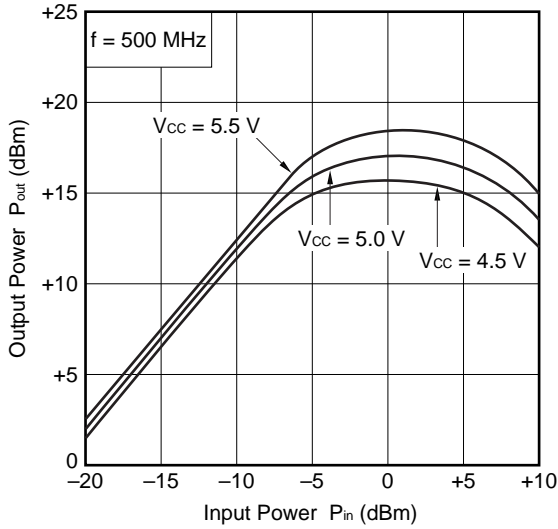

OUTPUT POWER vs. INPUT POWER

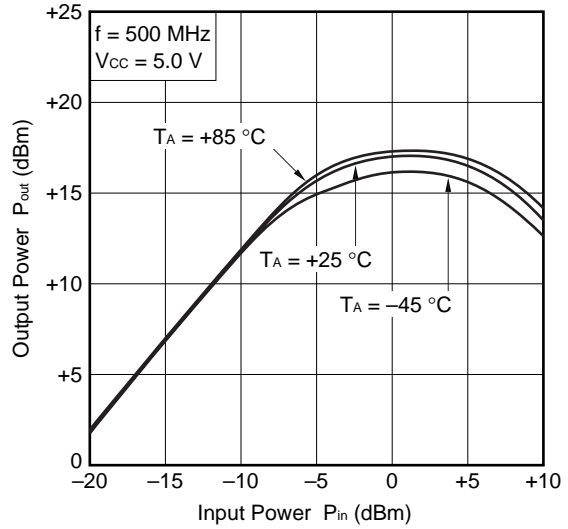

SATURATED OUTPUT POWER vs. FREQUENCY

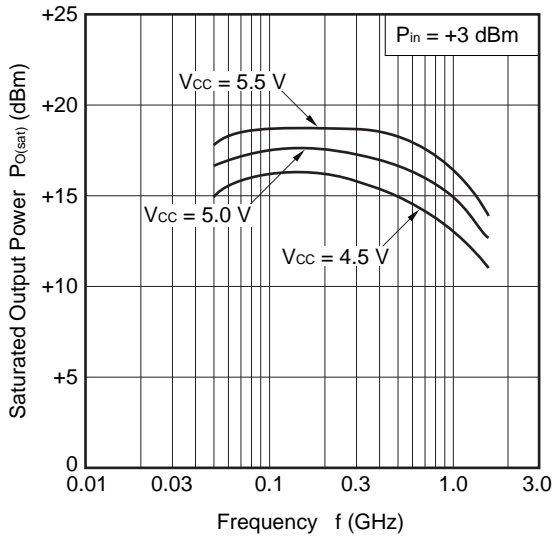

THIRD ORDER INTERMODULATION DISTORTION vs. OUTPUT POWER OF EACH TONE

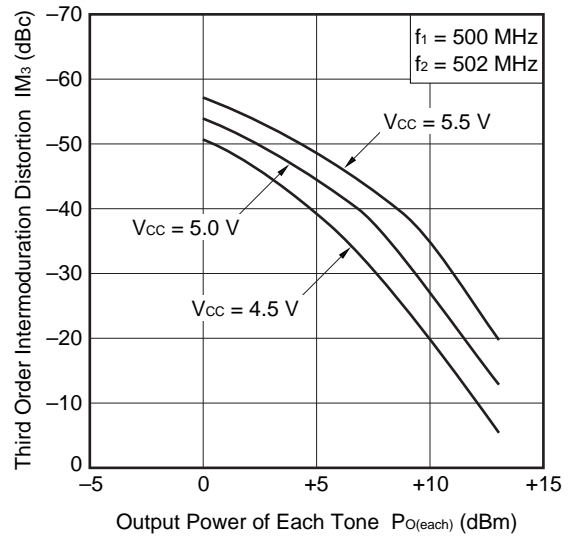

S-PARAMETER ($T_A = +25\text{ }^\circ\text{C}$, $V_{CC} = V_{out} = 5.0\text{ V}$)

S₁₁-FREQUENCY

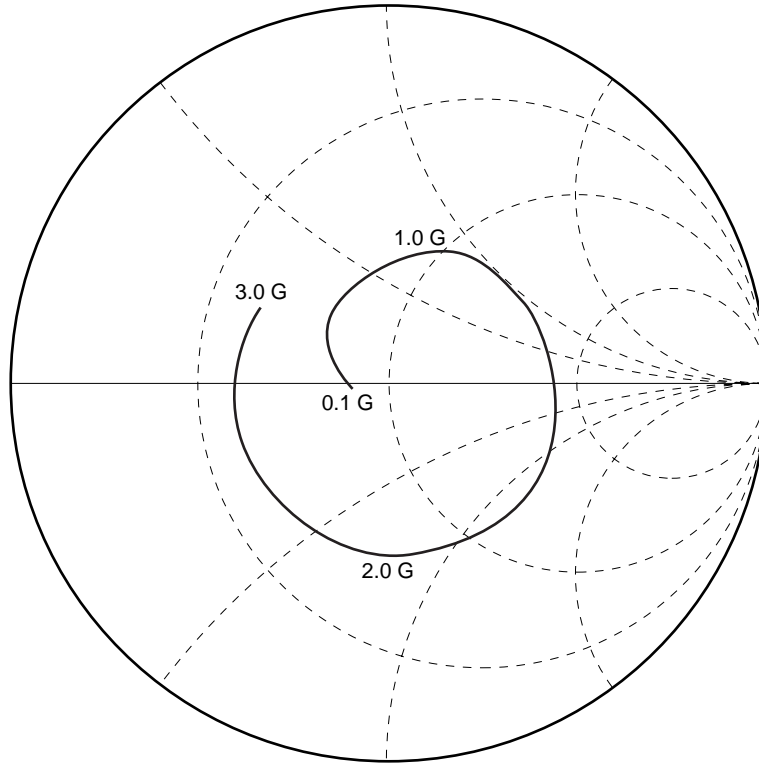

S₂₂-FREQUENCY

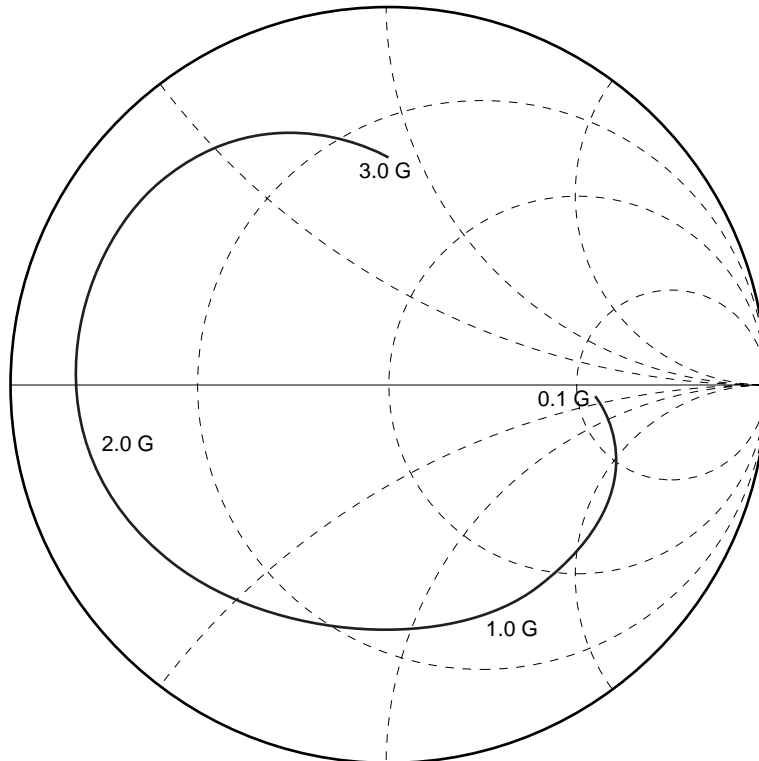

TYPICAL S-PARAMETER VALUES (T_A = +25 °C)

μPC1678G

V_{CC} = V_{out} = 5.0 V, I_{CC} = 49 mA

FREQUENCY MHz	S ₁₁		S ₂₁		S ₁₂		S ₂₂		K
	MAG.	ANG.	MAG.	ANG.	MAG.	ANG.	MAG.	ANG.	
100.0000	0.078	-173.8	12.298	-4.0	0.023	-6.4	0.555	-3.2	1.40
200.0000	0.106	-179.1	12.891	-8.6	0.020	-7.3	0.593	-8.7	1.43
300.0000	0.140	166.3	13.625	-14.8	0.016	-4.7	0.630	-16.4	1.59
400.0000	0.176	150.2	14.453	-22.6	0.014	6.4	0.657	-25.3	1.53
500.0000	0.212	132.9	15.257	-31.5	0.014	23.1	0.673	-35.4	1.38
600.0000	0.246	115.5	15.663	-40.8	0.017	35.1	0.676	-45.1	1.05
700.0000	0.275	99.2	16.156	-51.3	0.020	41.0	0.669	-55.0	0.86
800.0000	0.304	83.2	16.291	-60.7	0.024	42.4	0.654	-64.0	0.71
900.0000	0.323	68.2	16.289	-71.0	0.027	41.8	0.627	-72.4	0.65
1000.0000	0.403	53.3	17.096	-80.2	0.030	47.1	0.660	-76.7	0.45
1100.0000	0.408	37.1	16.669	-90.7	0.036	43.0	0.646	-85.4	0.44
1200.0000	0.421	22.2	16.591	-100.7	0.036	41.3	0.639	-93.7	0.44
1300.0000	0.436	6.4	16.370	-111.2	0.041	36.5	0.660	-101.7	0.41
1400.0000	0.449	-8.4	16.056	-121.8	0.042	33.9	0.670	-109.8	0.40
1500.0000	0.463	-25.0	15.852	-131.6	0.045	28.3	0.690	-118.7	0.40
1600.0000	0.474	-41.5	15.332	-142.8	0.049	25.9	0.717	-127.0	0.41
1700.0000	0.472	-58.3	14.865	-154.2	0.048	22.1	0.734	-136.6	0.45
1800.0000	0.468	-76.1	14.169	-164.9	0.049	15.7	0.763	-146.9	0.48
1900.0000	0.457	-92.5	13.229	-176.8	0.048	13.7	0.783	-156.8	0.54
2000.0000	0.447	-109.6	12.144	172.6	0.048	8.1	0.806	-167.8	0.58
2100.0000	0.447	-126.4	10.947	162.7	0.049	4.0	0.830	-178.6	0.64
2200.0000	0.434	-142.6	9.853	153.4	0.047	-2.0	0.843	170.2	0.69
2300.0000	0.429	-158.5	8.796	146.3	0.044	-6.7	0.842	159.4	0.77
2400.0000	0.427	-173.0	7.894	139.7	0.040	-9.9	0.843	148.2	0.86
2500.0000	0.422	172.5	7.048	133.3	0.036	-12.5	0.825	137.4	0.99
2600.0000	0.419	158.3	6.363	128.8	0.027	-17.6	0.785	125.7	1.34
2700.0000	0.416	145.6	5.881	125.1	0.023	-17.2	0.744	117.2	1.71
2800.0000	0.400	136.1	5.387	121.3	0.018	4.5	0.701	109.7	2.34
2900.0000	0.402	126.2	5.223	116.2	0.018	11.0	0.681	103.0	2.53
3000.0000	0.406	118.1	5.030	113.5	0.020	28.2	0.645	96.5	2.45
3100.0000	0.397	109.8	4.675	107.3	0.022	35.3	0.616	90.7	2.47

★ PACKAGE DIMENSIONS

8 PIN PLASTIC SOP (225 mil) (Unit: mm)

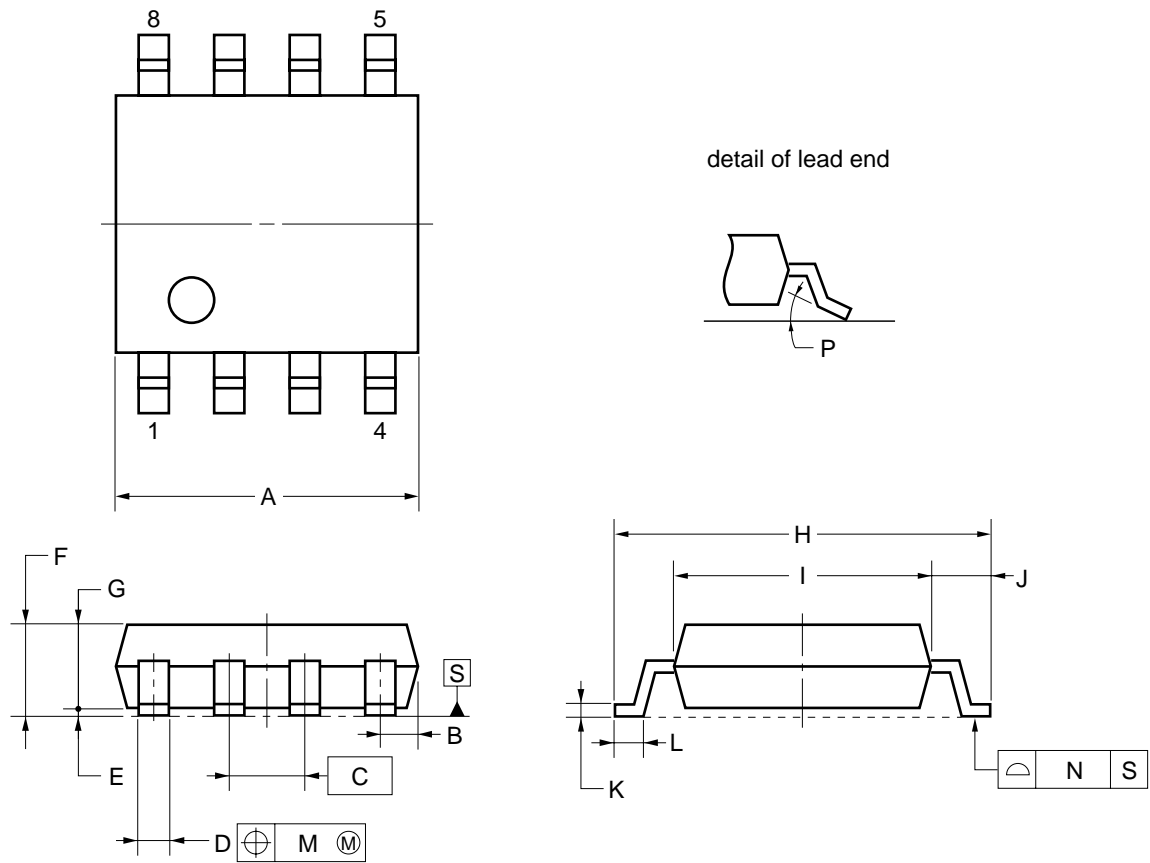

NOTE

Each lead centerline is located within 0.12 mm of its true position (T.P.) at maximum material condition.

ITEM	MILLIMETERS
A	5.2±0.2
B	0.85 MAX.
C	1.27 (T.P.)
D	0.42 ^{+0.08} _{-0.07}
E	0.1±0.1
F	1.57±0.2
G	1.49
H	6.5±0.3
I	4.4±0.15
J	1.1±0.2
K	0.17 ^{+0.08} _{-0.07}
L	0.6±0.2
M	0.12
N	0.10
P	3° ^{+7°} _{-3°}

NOTE ON CORRECT USE

- (1) Observe precautions for handling because of electro-static sensitive devices.
- (2) Form a ground pattern as widely as possible to keep minimum ground impedance (to prevent undesired oscillation).
All the ground pins must be connected together with wide ground pattern to decrease impedance difference.
- (3) The bypass capacitor should be attached to Vcc line.
- (4) The inductor must be attached between Vcc and output pins. The inductance value should be determined in accordance with desired frequency.
- (5) The DC cut capacitor must be each attached to the input and output pins.

RECOMMENDED SOLDERING CONDITIONS

This product should be soldered under the following recommended conditions. For soldering methods and conditions other than those recommended below, contact your NEC sales representative.

Soldering Method	Soldering Conditions	Recommended Condition Symbol
Infrared Reflow	Package peak temperature: 235 °C or below Time: 30 seconds or less (at 210 °C) Count: 3, Exposure limit ^{Note} : None	IR35-00-3
VPS	Package peak temperature: 215 °C or below Time: 40 seconds or less (at 200 °C) Count: 3, Exposure limit ^{Note} : None	VP15-00-3
Wave Soldering	Soldering bath temperature: 260 °C or below Time: 10 seconds or less Count: 1, Exposure limit ^{Note} : None	WS60-00-1
Partial Heating	Pin temperature: 300 °C Time: 3 seconds or less (per side of device) Exposure limit ^{Note} : None	-

Note After opening the dry pack, keep it in a place below 25 °C and 65 % RH for the allowable storage period.

Caution Do not use different soldering methods together (except for partial heating).

For details of recommended soldering conditions for surface mounting, refer to information document SEMICONDUCTOR DEVICE MOUNTING TECHNOLOGY MANUAL (C10535E).

[MEMO]

[MEMO]

[MEMO]

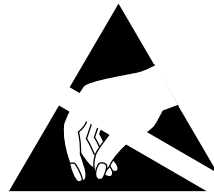

ATTENTION

OBSERVE PRECAUTIONS
FOR HANDLING
ELECTROSTATIC
SENSITIVE
DEVICES

NESAT (NEC Silicon Advanced Technology) is a trademark of NEC Corporation.

- **The information in this document is subject to change without notice. Before using this document, please confirm that this is the latest version.**
 - No part of this document may be copied or reproduced in any form or by any means without the prior written consent of NEC Corporation. NEC Corporation assumes no responsibility for any errors which may appear in this document.
 - NEC Corporation does not assume any liability for infringement of patents, copyrights or other intellectual property rights of third parties by or arising from use of a device described herein or any other liability arising from use of such device. No license, either express, implied or otherwise, is granted under any patents, copyrights or other intellectual property rights of NEC Corporation or others.
 - Descriptions of circuits, software, and other related information in this document are provided for illustrative purposes in semiconductor product operation and application examples. The incorporation of these circuits, software, and information in the design of the customer's equipment shall be done under the full responsibility of the customer. NEC Corporation assumes no responsibility for any losses incurred by the customer or third parties arising from the use of these circuits, software, and information.
 - While NEC Corporation has been making continuous effort to enhance the reliability of its semiconductor devices, the possibility of defects cannot be eliminated entirely. To minimize risks of damage or injury to persons or property arising from a defect in an NEC semiconductor device, customers must incorporate sufficient safety measures in its design, such as redundancy, fire-containment, and anti-failure features.
 - NEC devices are classified into the following three quality grades:
"Standard", "Special", and "Specific". The Specific quality grade applies only to devices developed based on a customer designated "quality assurance program" for a specific application. The recommended applications of a device depend on its quality grade, as indicated below. Customers must check the quality grade of each device before using it in a particular application.
 - Standard: Computers, office equipment, communications equipment, test and measurement equipment, audio and visual equipment, home electronic appliances, machine tools, personal electronic equipment and industrial robots
 - Special: Transportation equipment (automobiles, trains, ships, etc.), traffic control systems, anti-disaster systems, anti-crime systems, safety equipment and medical equipment (not specifically designed for life support)
 - Specific: Aircraft, aerospace equipment, submersible repeaters, nuclear reactor control systems, life support systems or medical equipment for life support, etc.
- The quality grade of NEC devices is "Standard" unless otherwise specified in NEC's Data Sheets or Data Books. If customers intend to use NEC devices for applications other than those specified for Standard quality grade, they should contact an NEC sales representative in advance.