

**Phase Leg & Dual Common Emitter
Power Module**

Fast Trench & Field Stop IGBT4 (Q1, Q2):

$V_{CES} = 1200V$; $I_C = 200A$ @ $T_c = 80^\circ C$

Trench & Field Stop IGBT3 (Q3, Q4):

$V_{CES} = 600V$; $I_C = 100A$ @ $T_c = 80^\circ C$

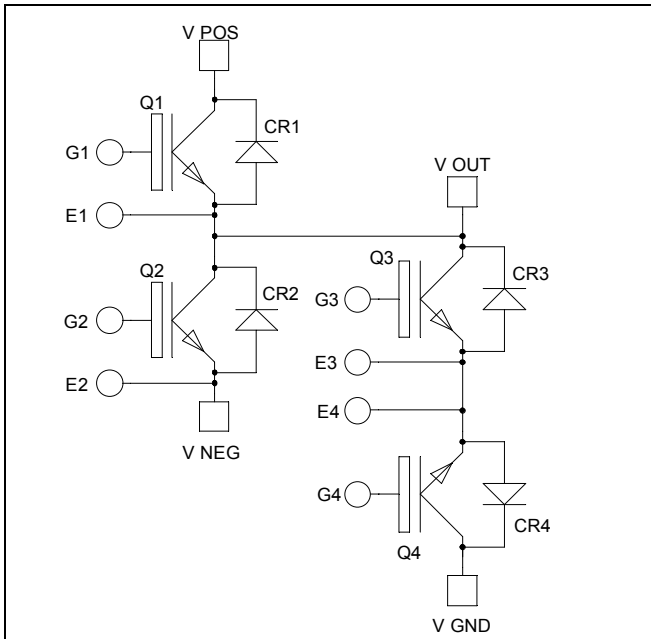

Application

- Uninterruptible Power Supplies

Features

- **Q1, Q2 (High speed Trench & Field Stop IGBT4)**
- **Q3, Q4 (Trench & Field Stop IGBT3)**
 - Low voltage drop
 - Low tail current
 - Low leakage current
 - RBSOA and SCSOA rated
- Kelvin emitter for easy drive
- Very low stray inductance
- High level of integration

Benefits

- Stable temperature behavior
- Very rugged
- Direct mounting to heatsink (isolated package)
- Low junction to case thermal resistance
- Easy paralleling due to positive T_C of V_{CESat}
- Low profile
- RoHS Compliant

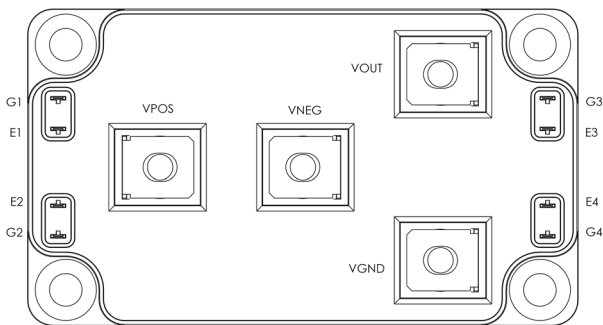

All ratings @ $T_j = 25^\circ C$ unless otherwise specified

CAUTION: These Devices are sensitive to Electrostatic Discharge. Proper Handling Procedures Should Be Followed.
See application note APT0502 on www.microsemi.com

1. High speed Trench & Field Stop IGBT4 Phase Leg Q1&Q2 (per IGBT)
Absolute maximum ratings

<i>Symbol</i>	<i>Parameter</i>	<i>Max ratings</i>	<i>Unit</i>
V_{CES}	Collector - Emitter Voltage	1200	V
I_C	Continuous Collector Current	$T_C = 25^\circ\text{C}$	300
		$T_C = 80^\circ\text{C}$	200
I_{CM}	Pulsed Collector Current	$T_C = 25^\circ\text{C}$	640
V_{GE}	Gate - Emitter Voltage	± 20	V
P_D	Maximum Power Dissipation	1000	W
RBSOA	Reverse Bias Safe Operating Area	$T_j = 150^\circ\text{C}$	320A @ 1100V

Electrical Characteristics

<i>Symbol</i>	<i>Characteristic</i>	<i>Test Conditions</i>	<i>Min</i>	<i>Typ</i>	<i>Max</i>	<i>Unit</i>	
I_{CES}	Zero Gate Voltage Collector Current	$V_{GE} = 0\text{V}, V_{CE} = 1200\text{V}$			200	μA	
$V_{CE(sat)}$	Collector Emitter Saturation Voltage	$V_{GE} = 15\text{V}$ $I_C = 160\text{A}$	$T_j = 25^\circ\text{C}$	1.7	2.05	2.4	V
			$T_j = 150^\circ\text{C}$		2.6		
$V_{GE(th)}$	Gate Threshold Voltage	$V_{GE} = V_{CE}, I_C = 4\text{mA}$	5.0	5.8	6.5	V	
I_{GES}	Gate - Emitter Leakage Current	$V_{GE} = 20\text{V}, V_{CE} = 0\text{V}$			480	nA	

Dynamic Characteristics

<i>Symbol</i>	<i>Characteristic</i>	<i>Test Conditions</i>	<i>Min</i>	<i>Typ</i>	<i>Max</i>	<i>Unit</i>
C_{ies}	Input Capacitance	$V_{GE} = 0\text{V}$ $V_{CE} = 25\text{V}$ $f = 1\text{MHz}$		9200		pF
C_{oes}	Output Capacitance			600		
C_{res}	Reverse Transfer Capacitance			540		
Q_G	Gate charge	$V_{GE} = 15\text{V}, I_C = 160\text{A}$ $V_{CE} = 960\text{V}$		740		nC
$T_{d(on)}$	Turn-on Delay Time	Inductive Switching (25°C) $V_{GE} = \pm 15\text{V}$ $V_{Bus} = 600\text{V}$ $I_C = 160\text{A}$ $R_G = 3\Omega$		30		ns
T_r	Rise Time			57		
$T_{d(off)}$	Turn-off Delay Time			290		
T_f	Fall Time			16		
$T_{d(on)}$	Turn-on Delay Time	Inductive Switching (150°C) $V_{GE} = \pm 15\text{V}$ $V_{Bus} = 600\text{V}$ $I_C = 160\text{A}$ $R_G = 3\Omega$		30		ns
T_r	Rise Time			49		
$T_{d(off)}$	Turn-off Delay Time			366		
T_f	Fall Time			48		
E_{on}	Turn on Energy	$V_{GE} = \pm 15\text{V}$ $V_{Bus} = 600\text{V}$ $I_C = 160\text{A}$ $R_G = 3\Omega$	$T_j = 25^\circ\text{C}$	12.6		mJ
			$T_j = 150^\circ\text{C}$	15		
E_{off}	Turn off Energy	$R_G = 3\Omega$	$T_j = 25^\circ\text{C}$	4.8		
			$T_j = 150^\circ\text{C}$	9		
I_{sc}	Short Circuit data	$V_{GE} \leq 15\text{V}; V_{Bus} = 600\text{V}$ $t_p \leq 10\mu\text{s}; T_j = 150^\circ\text{C}$		600		A
R_{thJC}	Junction to Case Thermal Resistance				0.15	$^\circ\text{C}/\text{W}$

Diode ratings and characteristics (D1 & D2) (per diode)

<i>Symbol</i>	<i>Characteristic</i>	<i>Test Conditions</i>		<i>Min</i>	<i>Typ</i>	<i>Max</i>	<i>Unit</i>
V _{RRM}	Peak Repetitive Reverse Voltage					1200	V
I _{RM}	Reverse Leakage Current	V _R =1200V				200	μA
I _F	DC Forward Current		T _c = 50°C		180		A
V _F	Diode Forward Voltage	I _F = 150A	T _j = 25°C		1.7	2.2	V
			T _j = 150°C		1.65		
t _{rr}	Reverse Recovery Time	I _F = 150A	T _j = 25°C		155		ns
			T _j = 150°C		300		
Q _{rr}	Reverse Recovery Charge	V _R = 600V di/dt = 3800A/μs	T _j = 25°C		14.6		μC
			T _j = 150°C		30.4		
E _{rr}	Reverse Recovery Energy	I _F = 150A V _R = 600V di/dt = 3800A/μs	T _j = 25°C		5.2		mJ
			T _j = 150°C		11		
R _{thJC}	Junction to Case Thermal Resistance					0.32	°C/W

2. Trench & Field Stop IGBT3 Dual common emitter Q3&Q4 (per IGBT)

<i>Symbol</i>	<i>Parameter</i>	<i>Max ratings</i>		<i>Unit</i>
V _{CES}	Collector - Emitter Voltage		600	V
I _C	Continuous Collector Current	T _C = 25°C	150	A
		T _C = 80°C	100	
I _{CM}	Pulsed Collector Current	T _C = 25°C	200	
V _{GE}	Gate - Emitter Voltage		±20	V
P _D	Maximum Power Dissipation	T _C = 25°C	340	W
RBSOA	Reverse Bias Safe Operating Area	T _j = 150°C	200A @ 550V	

Electrical Characteristics

<i>Symbol</i>	<i>Characteristic</i>	<i>Test Conditions</i>	<i>Min</i>	<i>Typ</i>	<i>Max</i>	<i>Unit</i>	
I _{CES}	Zero Gate Voltage Collector Current	V _{GE} = 0V, V _{CE} = 600V			250	μA	
V _{CE(sat)}	Collector Emitter Saturation Voltage	V _{GE} = 15V I _C = 100A	T _j = 25°C		1.5	1.9	V
			T _j = 150°C		1.7		
V _{GE(th)}	Gate Threshold Voltage	V _{GE} = V _{CE} , I _C = 1.5 mA	5.0	5.8	6.5	V	
I _{GES}	Gate - Emitter Leakage Current	V _{GE} = 20V, V _{CE} = 0V			400	nA	

Dynamic Characteristics

Symbol	Characteristic	Test Conditions	Min	Typ	Max	Unit
C _{ies}	Input Capacitance	V _{GE} = 0V		6100		pF
C _{oes}	Output Capacitance	V _{CE} = 25V		390		
C _{res}	Reverse Transfer Capacitance	f = 1MHz		190		
Q _G	Gate charge	V _{GE} = ±15V, I _C = 100A V _{CE} = 300V		1.1		μC
T _{d(on)}	Turn-on Delay Time	Inductive Switching (25°C) V _{GE} = ±15V V _{Bus} = 300V I _C = 100A R _G = 3.3Ω		115		ns
T _r	Rise Time			45		
T _{d(off)}	Turn-off Delay Time			225		
T _f	Fall Time			55		
T _{d(on)}	Turn-on Delay Time	Inductive Switching (150°C) V _{GE} = ±15V V _{Bus} = 300V I _C = 100A R _G = 3.3Ω		130		ns
T _r	Rise Time			50		
T _{d(off)}	Turn-off Delay Time			300		
T _f	Fall Time			70		
E _{on}	Turn on Energy	V _{GE} = ±15V V _{Bus} = 300V I _C = 100A R _G = 3.3Ω	T _j = 25°C	0.4		mJ
			T _j = 150°C	0.875		
E _{off}	Turn off Energy	I _C = 100A R _G = 3.3Ω	T _j = 25°C	2.5		mJ
			T _j = 150°C	3.5		
I _{sc}	Short Circuit data	V _{GE} ≤ 15V ; V _{Bus} = 360V t _p ≤ 10μs ; T _j = 150°C		500		A
R _{thJC}	Junction to Case Thermal Resistance				0.45	°C/W

Diode ratings and characteristics (D3 & D4) (per diode)

Symbol	Characteristic	Test Conditions	Min	Typ	Max	Unit
V _{RRM}	Peak Repetitive Reverse Voltage				600	V
I _{RM}	Reverse Leakage Current	V _R = 600V			250	μA
I _F	DC Forward current	T _c = 25°C		150		A
V _F	Diode Forward Voltage	I _F = 150A V _{GE} = 0V	T _j = 25°C	1.6	2	V
			T _j = 150°C	1.5		
t _{rr}	Reverse Recovery Time	I _F = 150A V _R = 300V di/dt = 3000A/μs	T _j = 25°C	130		ns
			T _j = 150°C	225		
Q _{rr}	Reverse Recovery Charge	I _F = 150A V _R = 300V di/dt = 3000A/μs	T _j = 25°C	6.5		μC
			T _j = 150°C	14.5		
E _r	Reverse Recovery Energy	I _F = 150A V _R = 300V di/dt = 3000A/μs	T _j = 25°C	1.6		mJ
			T _j = 150°C	3.5		
R _{thJC}	Junction to Case Thermal Resistance				0.52	°C/W

3. Thermal & Package characteristics

Symbol	Characteristic	Min	Max	Unit	
V_{ISOL}	RMS Isolation Voltage, any terminal to case $t = 1$ min, 50/60Hz	4000		V	
T_J	Operating junction temperature range	-40	175	°C	
T_{JOP}	Recommended junction temperature under switching conditions	-40	$T_{Jmax} - 25$		
T_{STG}	Storage Temperature Range	-40	125		
T_C	Operating Case Temperature	-40	100		
Torque	Mounting torque	To heatsink	M6	3	N.m
		For terminals	M5	2	
Wt	Package Weight		300	g	

Package outline (dimensions in mm)

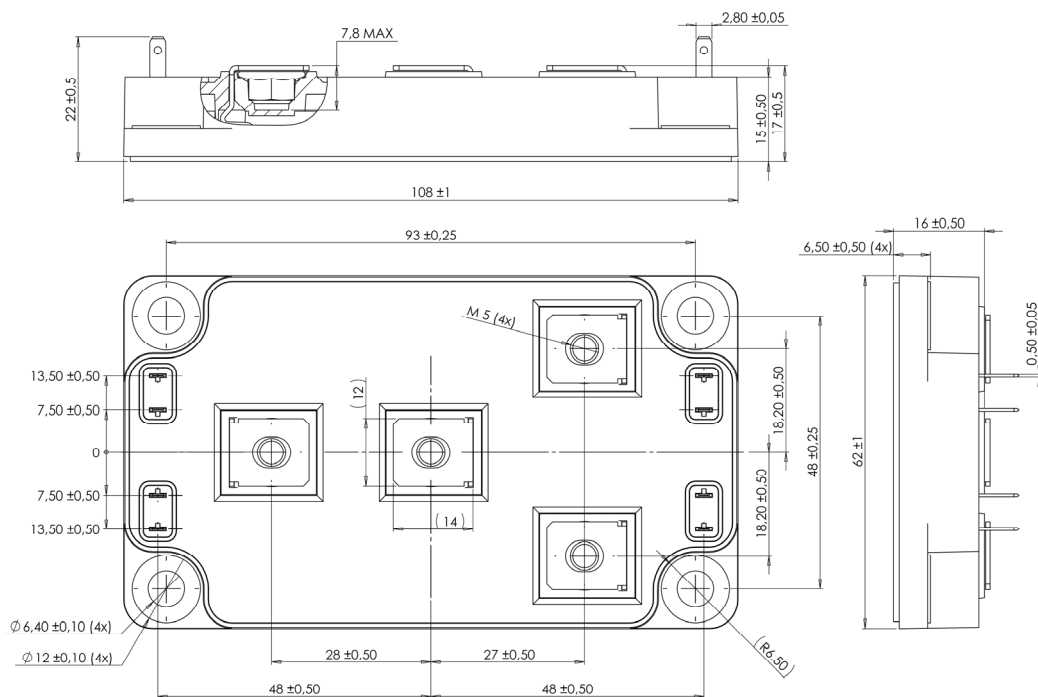

See application note APT0601 - Mounting Instructions for SP6 Power Modules on www.microsemi.com

High speed Trench & Field Stop IGBT4 performance curve (per IGBT)

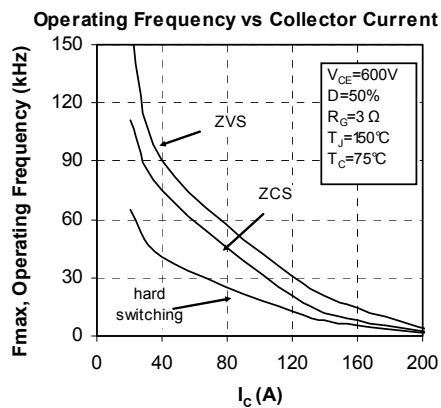

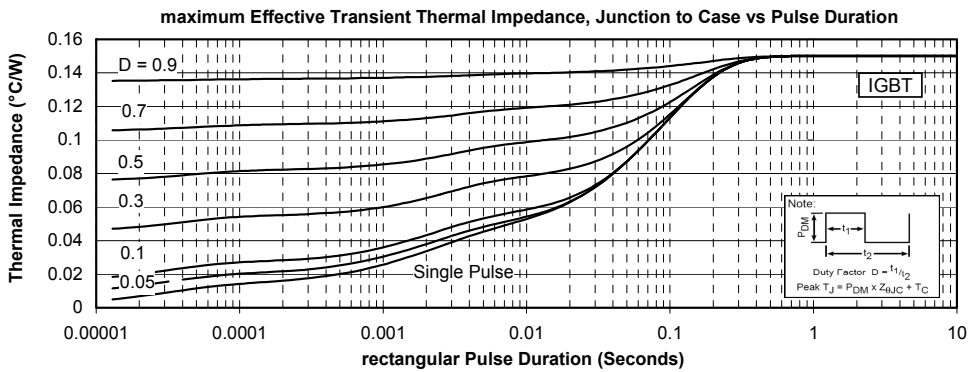
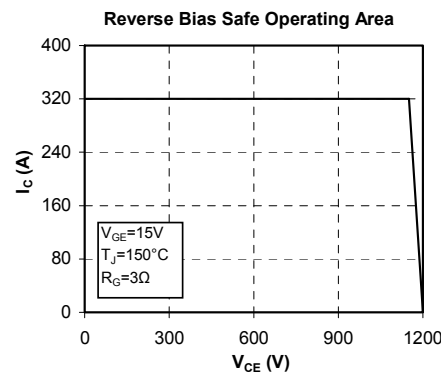
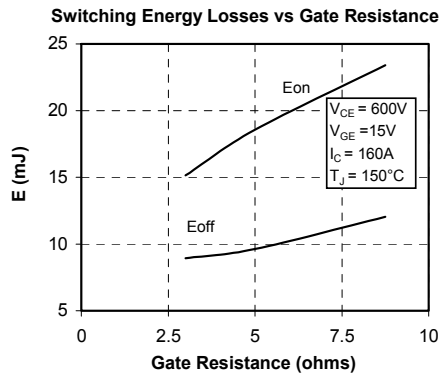
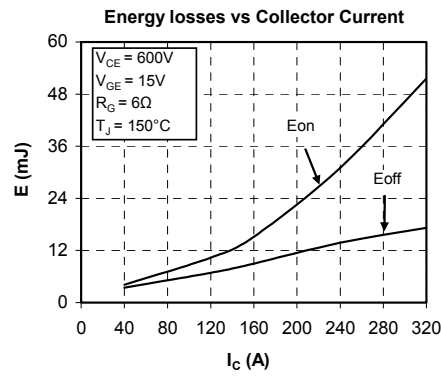
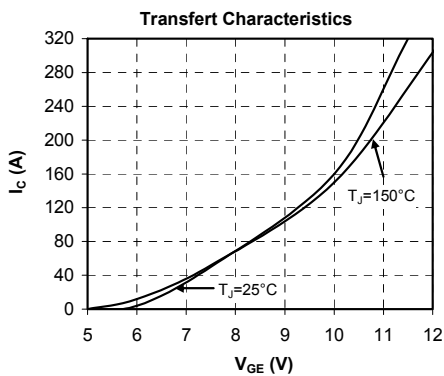
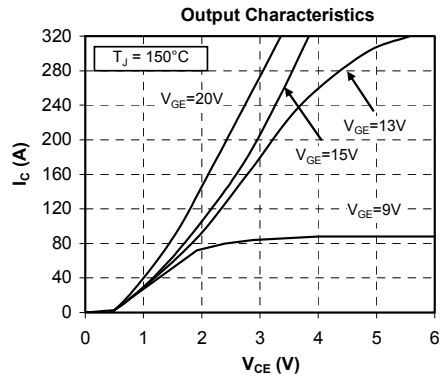
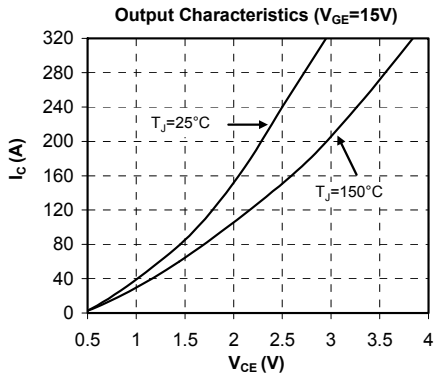

Diode D1 & D2 performance curve (per diode)

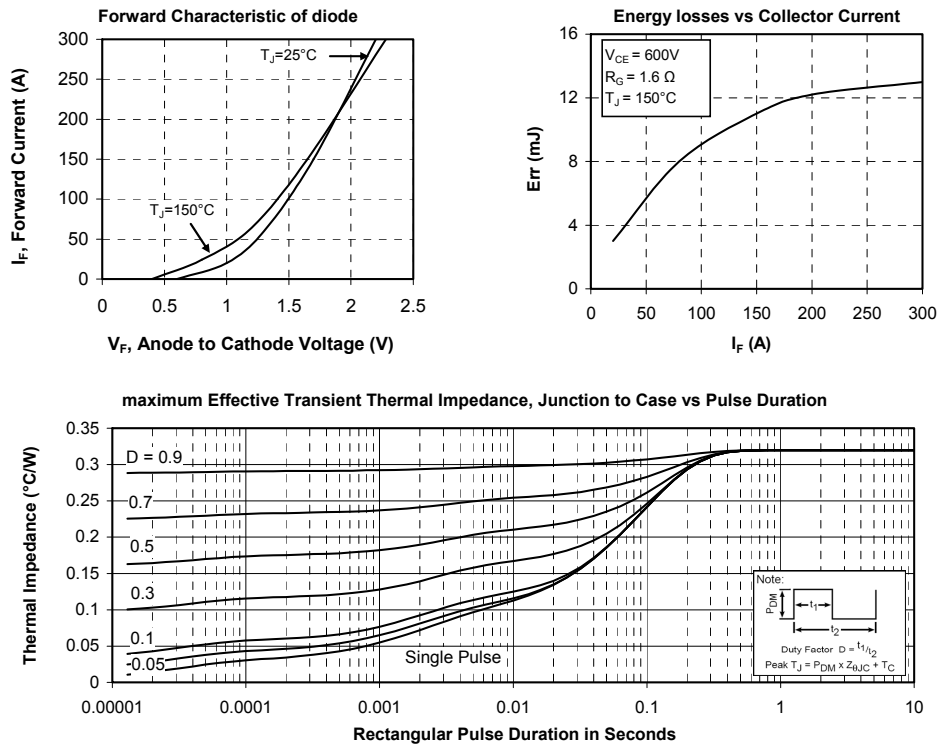

Trench & Field Stop IGBT3 performance curve (per IGBT)

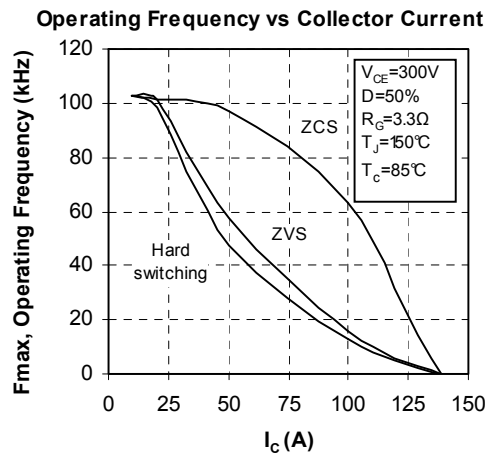

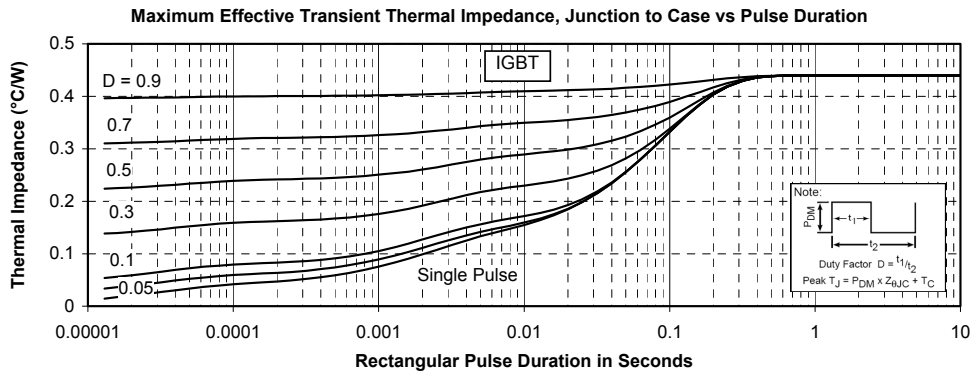
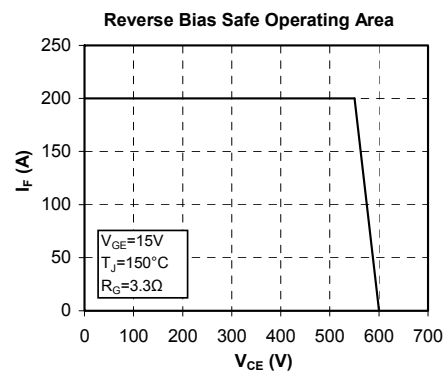
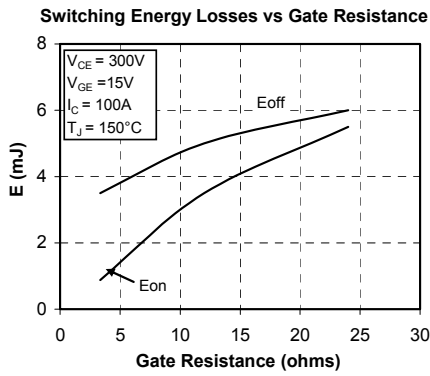
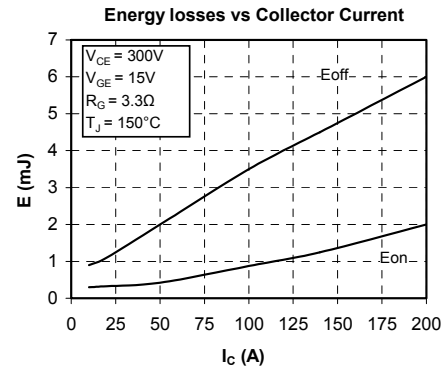
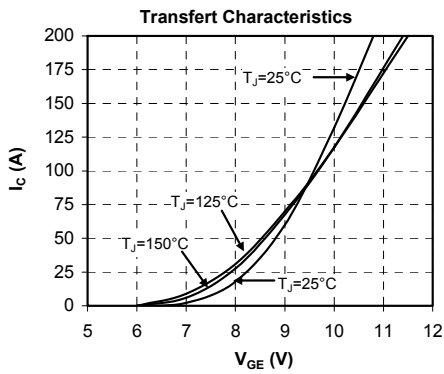
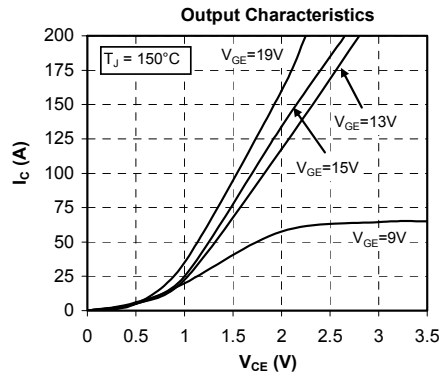
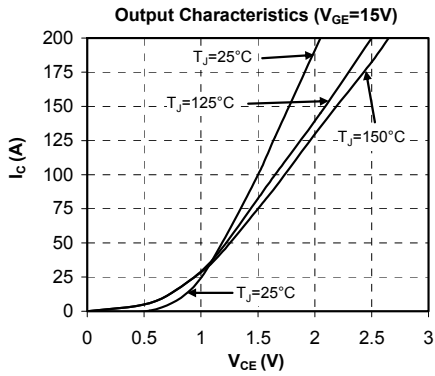

Diode D3 & D4 performance curve (per diode)

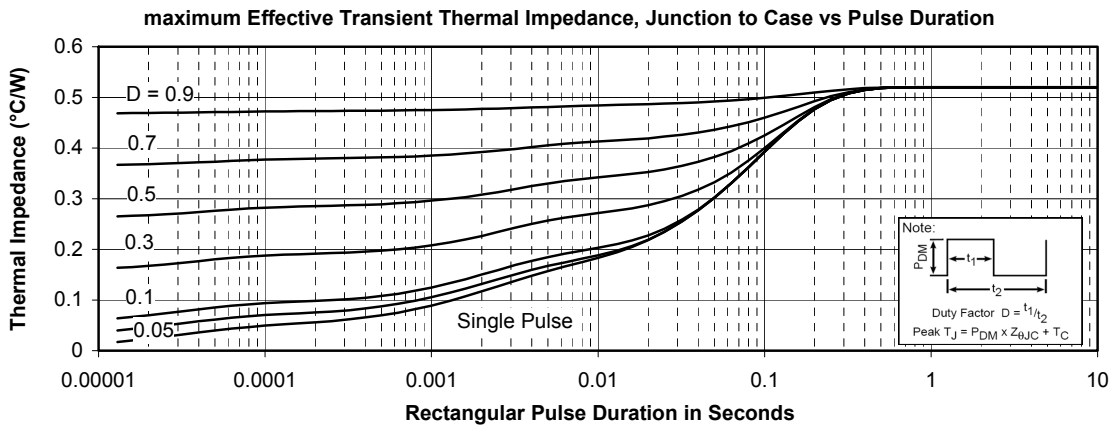
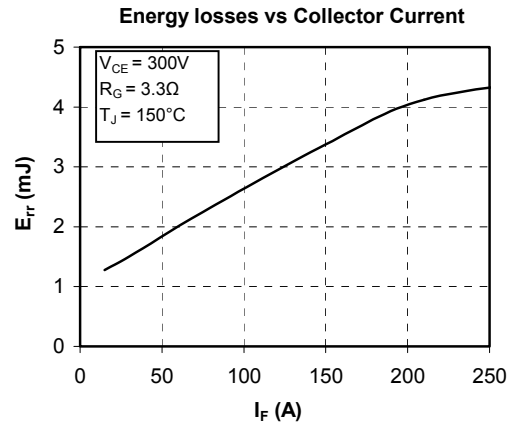
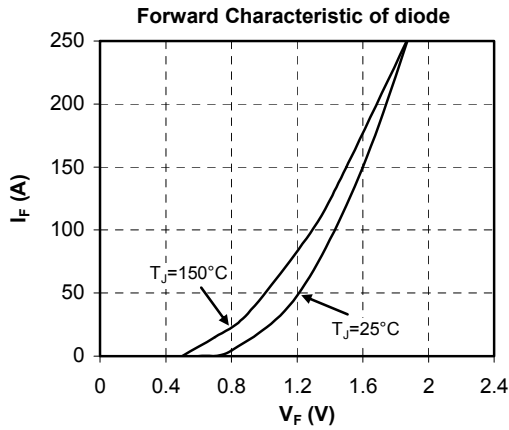

DISCLAIMER

The information contained in the document (unless it is publicly available on the Web without access restrictions) is PROPRIETARY AND CONFIDENTIAL information of Microsemi and cannot be copied, published, uploaded, posted, transmitted, distributed or disclosed or used without the express duly signed written consent of Microsemi. If the recipient of this document has entered into a disclosure agreement with Microsemi, then the terms of such Agreement will also apply. This document and the information contained herein may not be modified, by any person other than authorized personnel of Microsemi. No license under any patent, copyright, trade secret or other intellectual property right is granted to or conferred upon you by disclosure or delivery of the information, either expressly, by implication, inducement, estoppels or otherwise. Any license under such intellectual property rights must be approved by Microsemi in writing signed by an officer of Microsemi.

Microsemi reserves the right to change the configuration, functionality and performance of its products at anytime without any notice. This product has been subject to limited testing and should not be used in conjunction with life-support or other mission-critical equipment or applications. Microsemi assumes no liability whatsoever, and Microsemi disclaims any express or implied warranty, relating to sale and/or use of Microsemi products including liability or warranties relating to fitness for a particular purpose, merchantability, or infringement of any patent, copyright or other intellectual property right. Any performance specifications believed to be reliable but are not verified and customer or user must conduct and complete all performance and other testing of this product as well as any user or customers final application. User or customer shall not rely on any data and performance specifications or parameters provided by Microsemi. It is the customer's and user's responsibility to independently determine suitability of any Microsemi product and to test and verify the same. The information contained herein is provided "AS IS, WHERE IS" and with all faults, and the entire risk associated with such information is entirely with the User. Microsemi specifically disclaims any liability of any kind including for consequential, incidental and punitive damages as well as lost profit. The product is subject to other terms and conditions which can be located on the web at <http://www.microsemi.com/legal/tnc.asp>

Life Support Application

Seller's Products are not designed, intended, or authorized for use as components in systems intended for space, aviation, surgical implant into the body, in other applications intended to support or sustain life, or for any other application in which the failure of the Seller's Product could create a situation where personal injury, death or property damage or loss may occur (collectively "Life Support Applications").

Buyer agrees not to use Products in any Life Support Applications and to the extent it does it shall conduct extensive testing of the Product in such applications and further agrees to indemnify and hold Seller, and its officers, employees, subsidiaries, affiliates, agents, sales representatives and distributors harmless against all claims, costs, damages and expenses, and attorneys' fees and costs arising, directly or indirectly, out of any claims of personal injury, death, damage or otherwise associated with the use of the goods in Life Support Applications, even if such claim includes allegations that Seller was negligent regarding the design or manufacture of the goods.

Buyer must notify Seller in writing before using Seller's Products in Life Support Applications. Seller will study with Buyer alternative solutions to meet Buyer application specification based on Sellers sales conditions applicable for the new proposed specific part.