

### Thyristor/Diode and Thyristor/Thyristor, 90A (ADD-A-PAK Power Modules)



ADD-A-PAK

#### FEATURES

- High voltage
- Electrically isolated by DBC ceramic ( $Al_2O_3$ )
- 3000  $V_{RMS}$  isolating voltage
- Industrial standard package
- High surge capability
- Two elements in one package
- Modules uses high voltage power thyristors/diodes in two basic configurations
- Simple mounting
- UL approved file E320098
- Compliant to RoHS
- Designed and qualified for multiple level

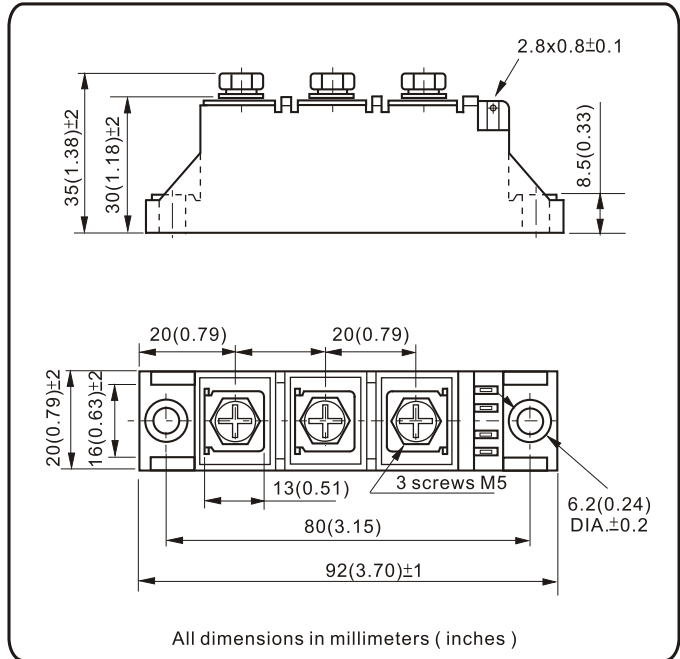

#### APPLICATIONS

- DC motor control and drives
- Battery charges
- Welders
- Power converters
- Lighting control
- Heat and temperature control

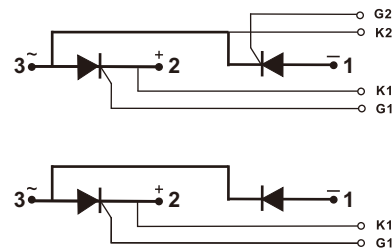

#### PRODUCT SUMMARY

$I_{T(AV)} / I_{F(AV)}$	90 A
-------------------------	------

MAJOR RATINGS AND CHARACTERISTICS			
SYMBOL	CHARACTERISTICS	VALUE	UNITS
$I_{T(AV)} / I_{F(AV)}$	85 °C	95	A
$I_{T(RMS)} / I_{F(RMS)}$	85 °C	149	A
$I_{TSM} / I_{FSM}$	50 Hz	2000	
	60 Hz	2100	
$I^2t$	50 Hz	20	kA <sup>2</sup> s
	60 Hz	18.3	
$I^2\sqrt{t}$		200	kA <sup>2</sup> √s
$V_{DRM} / V_{RRM}$	Range	600 to 1600	V
$T_J$	Range	-40 to 125	°C

### ELECTRICAL SPECIFICATIONS

VOLTAGE RATINGS				
TYPE NUMBER	VOLTAGE CODE	$V_{RRM}/V_{DRM}$ , MAXIMUM REPETITIVE PEAK REVERSE VOLTAGE V	$V_{RSM}/V_{DSM}$ , MAXIMUM NON-REPETITIVE PEAK REVERSE VOLTAGE V	$I_{RRM}/I_{DRM}$ AT 125 °C mA
NKT90 NKH90	08	800	900	10
	12	1200	1300	
	14	1400	1500	
	16	1600	1700	

FORWARD CONDUCTION						
PARAMETER	SYMBOL	TEST CONDITIONS			VALUE	UNITS
Maximum average on-state current (thyristors)	$I_{T(AV)}$	180° conduction, half sine wave, 50Hz, $T_C = 85^\circ\text{C}$			95	A
Maximum average forward current (diodes)	$I_{F(AV)}$					
Maximum RMS on-state current	$I_{T(RMS)}$ $I_{F(RMS)}$	180° conduction, half sine wave, 50Hz, $T_C = 85^\circ\text{C}$			149	A
Maximum peak, one-cycle, on-state non-repetitive surge current	$I_{TSM}$ $I_{FSM}$	t = 10 ms	No voltage reapplied	Sine half wave, initial $T_J = T_J$ maximum	2000	
		t = 8.3 ms			2100	
		t = 10 ms	100% $V_{RRM}$ reapplied		1680	
		t = 8.3 ms			1764	
Maximum $I^2t$ for fusing	$I^2t$	t = 10 ms	No voltage reapplied		20	
		t = 8.3 ms		18.3		
		t = 10 ms	100% $V_{RRM}$ reapplied	14.1		
		t = 8.3 ms		12.9		
Maximum $I^2\sqrt{t}$ for fusing	$I^2\sqrt{t}$	t = 0.1 ms to 10 ms, no voltage reapplied			200	$\text{kA}^2\sqrt{\text{s}}$
Value of threshold voltage	$V_{T(TO)}$	$T_J = T_J$ Maximum			0.80	V
Value of on-state slope resistance	$r_t$				3.01	$\text{m}\Omega$
Maximum on-state voltage drop	$V_{TM}$	$I_{TM} = 270\text{A}$ , $T_J = 25^\circ\text{C}$ , 180° conduction			1.7	V
Maximum forward voltage drop	$V_{FM}$	$I_{FM} = 270\text{A}$ , $T_J = 25^\circ\text{C}$ , 180° conduction			1.3	
Maximum holding current	$I_H$	Anode supply = 6V, resistive load $T_J = 25^\circ\text{C}$			250	mA
Maximum latching current	$I_L$				400	

BLOCKING					
PARAMETER	SYMBOL	TEST CONDITIONS		VALUES	UNITS
Maximum peak reverse and off-state leakage current	$I_{RRM}$ $I_{DRM}$	$T_J = 125^\circ\text{C}$		10	mA
RMS isolation Voltage	$V_{ISO}$	50 Hz, circuit to base, all terminals shorted		2500 (1min) 3000 (1s)	V
Critical rate of rise of off-state voltage	dV/dt	$T_J = T_J$ maximum, exponential to 67 % rated $V_{DRM}$		800	V/ $\mu\text{s}$

TRIGGERING					
PARAMETER	SYMBOL	TEST CONDITIONS		VALUES	UNITS
Maximum peak gate power	$P_{GM}$	$t_p \leq 5 \text{ ms}$ , $T_J = T_J \text{ maximum}$		10	W
Maximum average gate power	$P_{G(AV)}$	$f = 50 \text{ Hz}$ , $T_J = T_J \text{ maximum}$		3	
Maximum peak gate current	$I_{GM}$	$t_p \leq 5 \text{ ms}$ , $T_J = T_J \text{ maximum}$		3	A
Maximum peak negative gate voltage	$-V_{GM}$			10	V
Maximum required DC gate voltage to trigger	$V_{GT}$	$T_J = 25 \text{ }^\circ\text{C}$	Anode supply = 6 V, resistive load; $R_a = 1 \Omega$	0.7~1.10	
Maximum required DC gate current to trigger	$I_{GT}$			30~100	mA
Maximum gate voltage that will not trigger	$V_{GD}$	$T_J = T_J \text{ maximum}$ , 66.7% $V_{DRM}$ applied		0.25	V
Maximum gate current that will not trigger	$I_{GD}$			10	mA
Maximum rate of rise of turned-on current	$di/dt$	$T_J = 25^\circ\text{C}$ , Gate drive 20V, 20 $\Omega$ , $t_r \leq 0.5 \mu\text{s}$		150	A/ $\mu\text{s}$

THERMAL AND MECHANICAL SPECIFICATIONS					
PARAMETER	SYMBOL	TEST CONDITIONS		VALUES	UNITS
Maximum junction operating temperature range	$T_J$			- 40 to 125	$^\circ\text{C}$
Maximum storage temperature range	$T_{Stg}$			- 40 to 140	
Maximum thermal resistance, junction to case per junction	$R_{thJC}$	DC operation		0.28	$^\circ\text{C/W}$
Maximum thermal resistance, case to heatsink per module	$R_{thCS}$	Mounting surface, smooth, flat and greased		0.10	
Mounting torque $\pm 10 \%$	AAP to heatsink, M6 busbar to AAP, M5	A mounting compound is recommended and the torque should be rechecked after a period of 3 hours to allow for the spread of the compound. Lubricated threads.		4	N.m
Approximate weight				175	g
				6.2	oz.
Case style				ADD-A-PAK	

### ORDERING INFORMATION TABLE

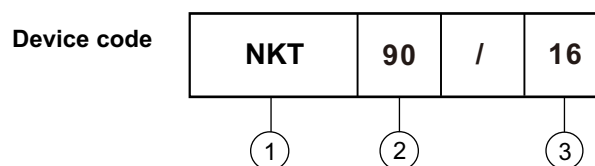

- 1 - Module type: NKT for (Thyristor + Thyristor) module  
NKH for (Thyristor + Diode) module
- 2 - Current rating: 90 for 95A
- 3 - Voltage code  $\times 100 = V_{RRM}$

**Fig.1 Peak On-state voltage vs. peak On-state current**

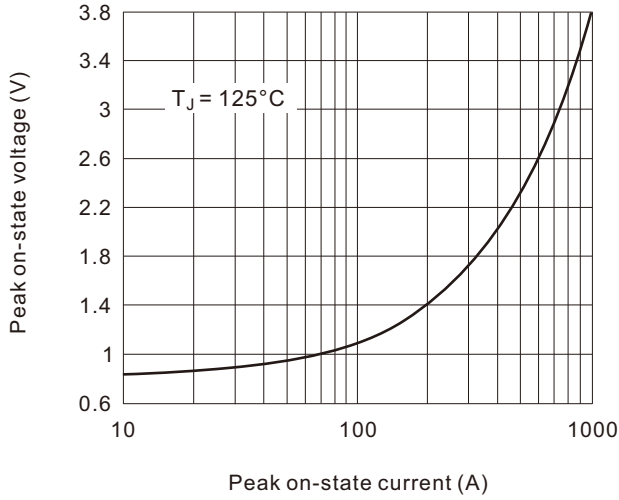

**Fig.2 Max. thermal impedance (junction to case) vs. time**

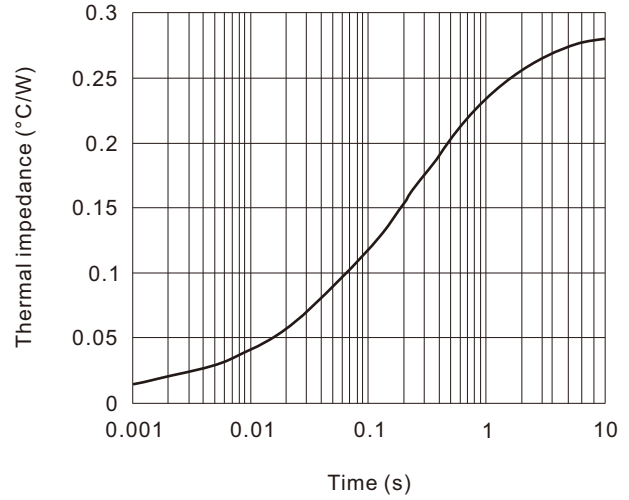

**Fig.3 Power dissipation vs. average on-state current**

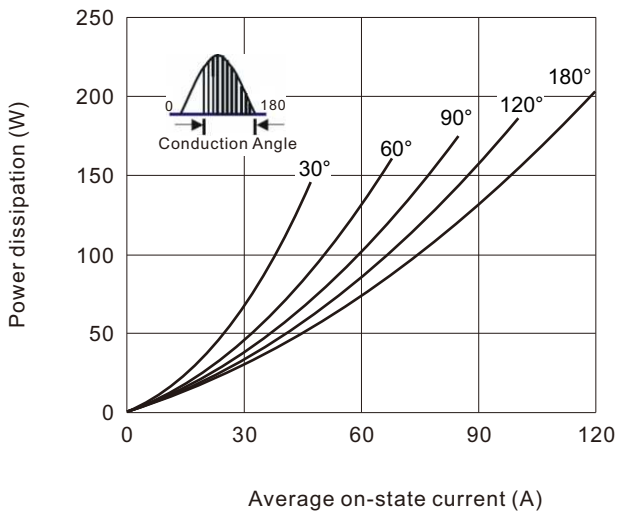

**Fig.4 Case temperature vs. average on-state current**

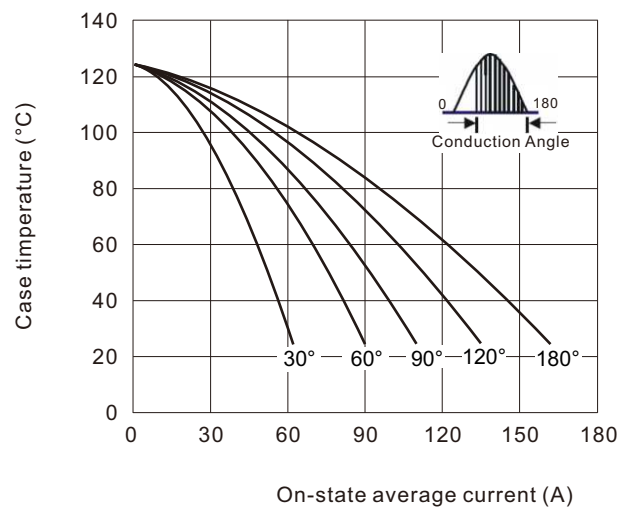

**Fig.5 Surge on-state current vs. cycles**

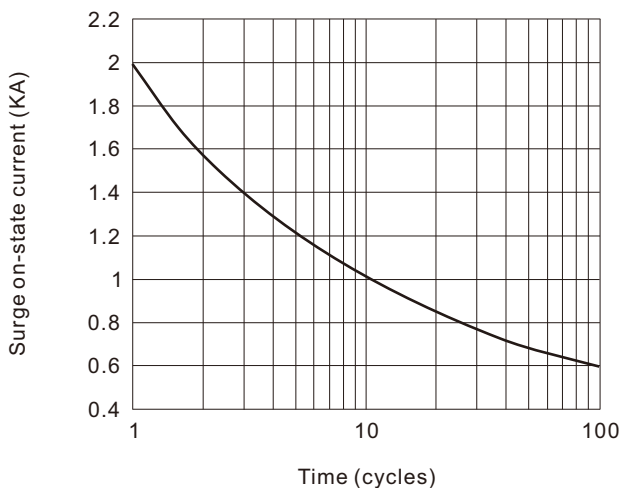

**Fig.6 Gate characteristics**

