

PT7707 Series

18 AMP "BIG-HAMMER" PROGRAMMABLE INTEGRATED SWITCHING REGULATOR

Revised 7/24/98

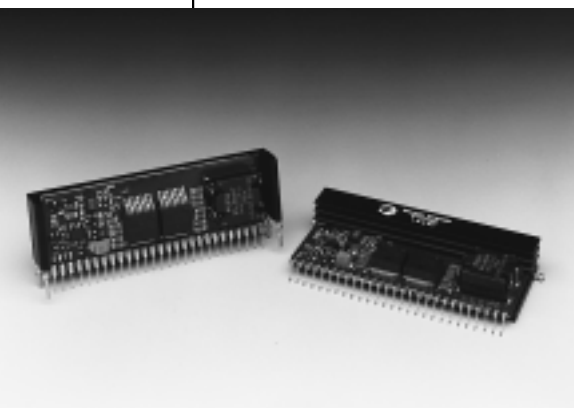

The PT7707 is a new series of high-performance, 18 Amp Integrated Switching Regulators (ISRs) housed in a 27-pin SIP package. The 18A capability allows easy integration of the latest high-speed, low-voltage μ Ps and bus drivers into existing 5V systems.

The PT7707 series has been designed to work in parallel with one or more of the PT7749 - 18A current boosters for increased I_{out} in incre-

ments of 18A.

The output voltage of the PT7707 can be easily programmed from 1.3V to 3.5V with a 5 bit input compatible with Intel's Pentium® II Processor. A differential remote sense is also provided which automatically compensates for any voltage drop from the ISR to the load.

Only 330 μ F of output capacitance are required for proper operation.

Standard Application

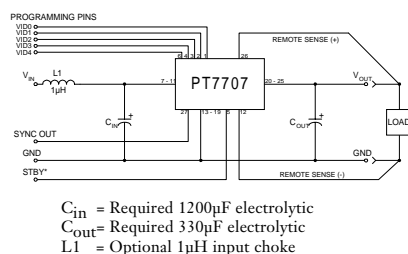

Pin-Out Information

Pin Function	Pin Function	Pin Function
1 VID0	10 V_{in}	19 GND
2 VID1	11 V_{in}	20 V_{out}
3 VID2	12 Remote Sense Gnd	21 V_{out}
4 VID3	13 GND	22 V_{out}
5 STBY* - Stand-by	14 GND	23 V_{out}
6 VID4	15 GND	24 V_{out}
7 V_{in}	16 GND	25 V_{out}
8 V_{in}	17 GND	26 Remote Sense V_{out}
9 V_{in}	18 GND	27 Sync Out

For STBY* pin; open = output enabled; ground = output disabled.

Specifications

Characteristics ($T_a = 25^\circ\text{C}$ unless noted)	Symbols	Conditions	PT7707 SERIES				
			Min	Typ	Max	Units	
Output Current	I_o	$T_a = +60^\circ\text{C}$, 200 LFM, pkg N $T_a = +25^\circ\text{C}$, natural convection	0.1*	—	18**	A	
Input Voltage Range	V_{in}	$0.1\text{A} \leq I_o \leq 15\text{A}$	4.5***	—	5.5	V	
Output Voltage Tolerance	ΔV_o	$V_{in} = +5\text{V}$, $I_o = 15\text{A}$ $0^\circ\text{C} \leq T_a \leq +65^\circ\text{C}$	$V_o - 0.03$	—	$V_o + 0.03$	V	
Line Regulation	Reg_{line}	$4.5\text{V} \leq V_{in} \leq 5.5\text{V}$, $I_o = 15\text{A}$	—	± 10	—	mV	
Load Regulation	Reg_{load}	$V_{in} = +5\text{V}$, $0.1 \leq I_o \leq 15\text{A}$	—	± 10	—	mV	
V_o Ripple/Noise	V_n	$V_{in} = +5\text{V}$, $I_o = 15\text{A}$	—	50	—	mV	
Transient Response with $C_{out} = 330\mu\text{F}$	t_{tr}	I_o step between 7.5A and 15A V_o over/undershoot	—	100	—	μSec	
	V_{os}		—	200	—	mV	
Efficiency	η	$V_{in} = +5\text{V}$, $I_o = 10\text{A}$	$V_o = 3.3\text{V}$	—	89	—	%
			$V_o = 2.9\text{V}$	—	87	—	%
			$V_o = 2.5\text{V}$	—	85	—	%
			$V_o = 1.8\text{V}$	—	79	—	%
			$V_o = 1.5\text{V}$	—	77	—	%
Switching Frequency	f_o	$4.5\text{V} \leq V_{in} \leq 5.5\text{V}$ $0.1\text{A} \leq I_o \leq 15\text{A}$	650	700	750	kHz	
Absolute Maximum Operating Temperature Range	T_a	—	0	—	+85	$^\circ\text{C}$	
Recommended Operating Temperature Range	T_a	Forced Air Flow = 200 LFM Over V_{in} and I_o Ranges	0	—	+65****	$^\circ\text{C}$	
Storage Temperature	T_s	—	-40	—	+125	$^\circ\text{C}$	
Mechanical Shock		Per Mil-STD-883D, Method 2002.3 1 msec, Half Sine, mounted to a fixture	—	500	—	G's	
Mechanical Vibration		Per Mil-STD-883D, Method 2007.2, 20-2000 Hz, Soldered in a PC board	—	10	—	G's	
Weight	—	Vertical/Horizontal	—	31/41	—	grams	

* ISR-will operate down to no load with reduced specifications. Please note that this product is not short-circuit protected.

**The PT7707 series can be easily paralleled with one or more of the PT7749 Current Boosters to provide increased output current in increments of 18A.

*** The minimum input voltage is 4.5V or $V_{out} + 1.2\text{V}$, whichever is greater. ****See SOA curves.

Output Capacitors: The PT7707 series requires a minimum output capacitance of 330 μ F for proper operation. Do not use Oscon type capacitors. The maximum allowable output capacitance is 15,000 μ F.

Input Filter: An input filter is optional for most applications. The input inductor must be sized to handle 18A DC with a typical value of 1 μ H. The input capacitance must be rated for a minimum of 1.3Arms of ripple current. For transient or dynamic load applications, additional capacitance may be required.

PT7707 Series

Features

- Single-Device: +5V input
- 5-bit Programmable: 1.3V to 3.5V@18A
- High Efficiency
- Input Voltage Range: 4.5V to 5.5V
- Differential Remote Sense
- 27-pin SIP Package
- Parallelable with PT7749 18A "Current Boosters"

Programming Information

VID3	VID2	VID1	VID0	VID4=1 Vout	VID4=0 Vout
1	1	1	1	2.0V	1.30V
1	1	1	0	2.1V	1.35V
1	1	0	1	2.2V	1.40V
1	1	0	0	2.3V	1.45V
1	0	1	1	2.4V	1.50V
1	0	1	0	2.5V	1.55V
1	0	0	1	2.6V	1.60V
1	0	0	0	2.7V	1.65V
0	1	1	1	2.8V	1.70V
0	1	1	0	2.9V	1.75V
0	1	0	1	3.0V	1.80V
0	1	0	0	3.1V	1.85V
0	0	1	1	3.2V	1.90V
0	0	1	0	3.3V	1.95V
0	0	0	1	3.4V	2.00V
0	0	0	0	3.5V	2.05V

Logic 0 = Pin 12 potential (remote sense gnd)
 Logic 1 = Open circuit (no pull-up resistors)
 VID3 and VID4 may not be changed while the unit is operating.

Ordering Information

PT7707□ = 1.3 to 3.5 Volts

(For dimensions and PC board layout, see Package Styles 800 and 810.)

PT Series Suffix (PT1234X)

Case/Pin

Configuration

Vertical Through-Hole	N
Horizontal Through-Hole	A
Horizontal Surface Mount	C

CHARACTERISTIC DATA

PT7707, $V_o = 3.3\text{ VDC}$ (See Note 1)

Safe Operating Area Curves (@ $V_{in}=+5V$)

PKG SUFFIX N

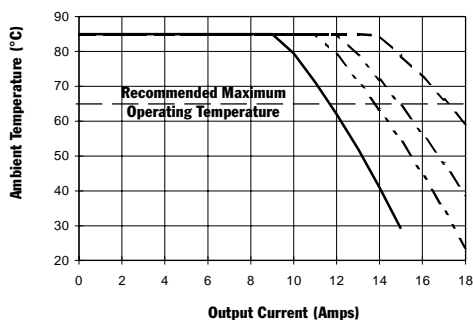

PKG SUFFIX A, C

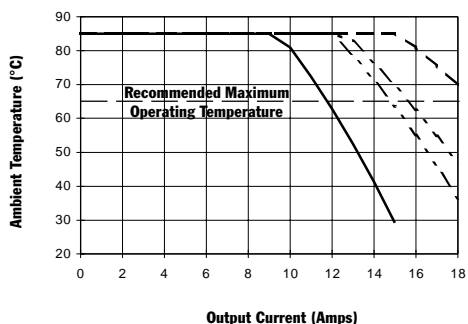

PT7707, $V_o = 3.3\text{ VDC}$ (See Note 1)

Efficiency vs Output Current

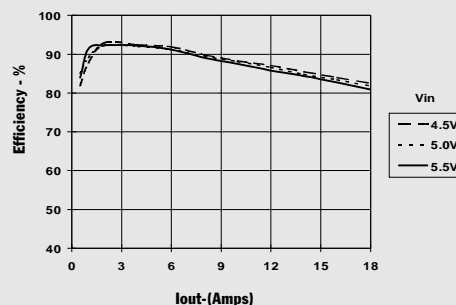

Ripple vs Output Current

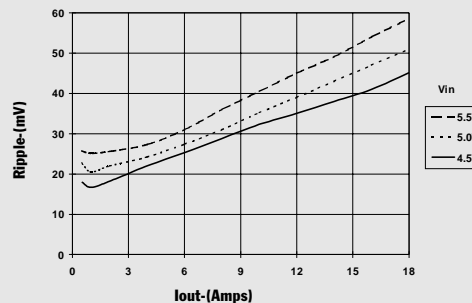

Power Dissipation vs Output Current

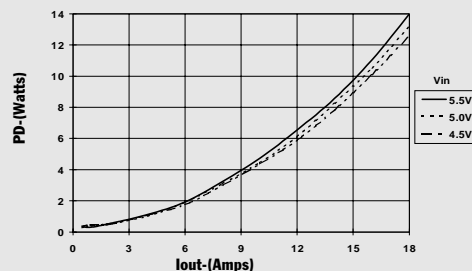

Note 1: All data listed in the above graphs has been developed from actual products tested at 25°C. This data is considered typical data for the ISR.

Note 2: SOA curves represent operating conditions at which internal components are at or below manufacturer's maximum rated operating temperatures.

[More Application Notes](#)**Pin-Coded Output Voltage Adjustment on the “Big Hammer” Series ISRs**

The ISRs related to Power Trends’ PT7705 incorporate pin-coded voltage control to adjust the output voltage. The control pins are identified VID0 - VID4 (pins 1, 2, 3, 4, & 6) respectively. When the control pins are left open-circuit, the ISR output will regulate at its factory trimmed output voltage. Each pin is internally connected to a precision resistor, which when grounded changes the output voltage by a set amount. By selectively grounding VID0 -VID4, the output voltage these ISRs can be programmed in incremental steps over the specified output voltage range. In each case, the program code and output voltage range offered by these ISRs are compatible with the voltage ID specification defined by Intel Corporation for voltage regulator modules (VRMs) used to power Pentium® microprocessors. Refer to Figure 1 below for the connection schematic, and the respective device Data Sheet for the appropriate programming code information.

Notes:

- The programming convention is as follows:-
 Logic 0: Connect to pin12 (Remote Sense Ground).
 Logic 1: Open circuit/open drain (See notes 2, & 4)
- Do not connect pull-up resistors to the voltage programming pins.
- To minimize output voltage error, always use pin 12 (Remote Sense Ground) as the logic “0” reference. While the regular ground (pins 13-19) can also be used for programming, doing so will degrade the load regulation of the product.

- If active devices are used to ground the voltage control pins, low-level open drain MOSFET devices should be used over bipolar transistors. The inherent $V_{ce(sat)}$ in bipolar devices introduces errors in the device’s internal divider network. Discrete transistors such as the BSS138, 2N7002, IRLML2402, or the 74C906 hex open-drain buffer are examples of appropriate devices.

Active Voltage Programming:

Special precautions should be taken when making changes to the voltage control program code while the unit is powered. It is highly recommended that the ISR be either powered down or held in standby. Changes made to the program code while V_{out} is enabled induces high current transients through the device. This is the result of the electrolytic output capacitors being either charged or discharged to the new output voltage set-point. The transient current can be minimized by making only incremental changes to the binary code, i.e. one LSB at a time. A minimum of 100 μ s settling time between each program state is also recommended. Making non-incremental changes to VID3 and VID4 with the output enabled is discouraged. If they are changed, the transients induced can overstress the device resulting in a permanent drop in efficiency. If the use of active devices prevents the program code being asserted prior to power-up, pull pin 5 (STBY) to the device GND during the period that the input voltage is applied to V_{in} . Releasing pin 5 will then allow the device output to execute a soft-start power-up to the programmed voltage.

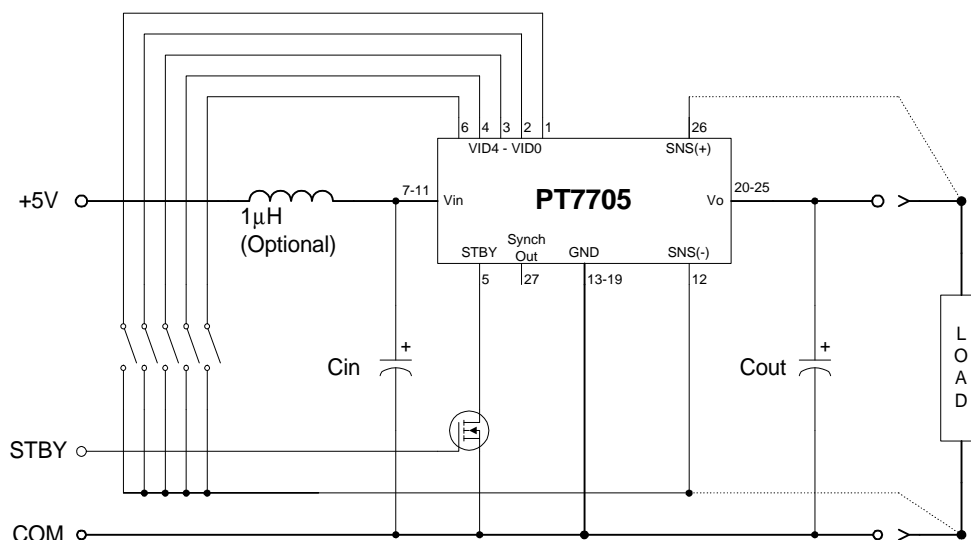
Figure 1

PACKAGING INFORMATION

Orderable Device	Status ⁽¹⁾	Package Type	Package Drawing	Pins	Package Qty	Eco Plan ⁽²⁾	Lead/Ball Finish	MSL Peak Temp ⁽³⁾
PT7707C	NRND	SIP MOD ULE	EHC	27	8	TBD	Call TI	Level-1-215C-UNLIM

⁽¹⁾ The marketing status values are defined as follows:

ACTIVE: Product device recommended for new designs.

LIFEBUY: TI has announced that the device will be discontinued, and a lifetime-buy period is in effect.

NRND: Not recommended for new designs. Device is in production to support existing customers, but TI does not recommend using this part in a new design.

PREVIEW: Device has been announced but is not in production. Samples may or may not be available.

OBSOLETE: TI has discontinued the production of the device.

⁽²⁾ Eco Plan - The planned eco-friendly classification: Pb-Free (RoHS), Pb-Free (RoHS Exempt), or Green (RoHS & no Sb/Br) - please check <http://www.ti.com/productcontent> for the latest availability information and additional product content details.

TBD: The Pb-Free/Green conversion plan has not been defined.

Pb-Free (RoHS): TI's terms "Lead-Free" or "Pb-Free" mean semiconductor products that are compatible with the current RoHS requirements for all 6 substances, including the requirement that lead not exceed 0.1% by weight in homogeneous materials. Where designed to be soldered at high temperatures, TI Pb-Free products are suitable for use in specified lead-free processes.

Pb-Free (RoHS Exempt): This component has a RoHS exemption for either 1) lead-based flip-chip solder bumps used between the die and package, or 2) lead-based die adhesive used between the die and leadframe. The component is otherwise considered Pb-Free (RoHS compatible) as defined above.

Green (RoHS & no Sb/Br): TI defines "Green" to mean Pb-Free (RoHS compatible), and free of Bromine (Br) and Antimony (Sb) based flame retardants (Br or Sb do not exceed 0.1% by weight in homogeneous material)

⁽³⁾ MSL, Peak Temp. -- The Moisture Sensitivity Level rating according to the JEDEC industry standard classifications, and peak solder temperature.

Important Information and Disclaimer:The information provided on this page represents TI's knowledge and belief as of the date that it is provided. TI bases its knowledge and belief on information provided by third parties, and makes no representation or warranty as to the accuracy of such information. Efforts are underway to better integrate information from third parties. TI has taken and continues to take reasonable steps to provide representative and accurate information but may not have conducted destructive testing or chemical analysis on incoming materials and chemicals. TI and TI suppliers consider certain information to be proprietary, and thus CAS numbers and other limited information may not be available for release.

In no event shall TI's liability arising out of such information exceed the total purchase price of the TI part(s) at issue in this document sold by TI to Customer on an annual basis.

IMPORTANT NOTICE

Texas Instruments Incorporated and its subsidiaries (TI) reserve the right to make corrections, modifications, enhancements, improvements, and other changes to its products and services at any time and to discontinue any product or service without notice. Customers should obtain the latest relevant information before placing orders and should verify that such information is current and complete. All products are sold subject to TI's terms and conditions of sale supplied at the time of order acknowledgment.

TI warrants performance of its hardware products to the specifications applicable at the time of sale in accordance with TI's standard warranty. Testing and other quality control techniques are used to the extent TI deems necessary to support this warranty. Except where mandated by government requirements, testing of all parameters of each product is not necessarily performed.

TI assumes no liability for applications assistance or customer product design. Customers are responsible for their products and applications using TI components. To minimize the risks associated with customer products and applications, customers should provide adequate design and operating safeguards.

TI does not warrant or represent that any license, either express or implied, is granted under any TI patent right, copyright, mask work right, or other TI intellectual property right relating to any combination, machine, or process in which TI products or services are used. Information published by TI regarding third-party products or services does not constitute a license from TI to use such products or services or a warranty or endorsement thereof. Use of such information may require a license from a third party under the patents or other intellectual property of the third party, or a license from TI under the patents or other intellectual property of TI.

Reproduction of TI information in TI data books or data sheets is permissible only if reproduction is without alteration and is accompanied by all associated warranties, conditions, limitations, and notices. Reproduction of this information with alteration is an unfair and deceptive business practice. TI is not responsible or liable for such altered documentation. Information of third parties may be subject to additional restrictions.

Resale of TI products or services with statements different from or beyond the parameters stated by TI for that product or service voids all express and any implied warranties for the associated TI product or service and is an unfair and deceptive business practice. TI is not responsible or liable for any such statements.

TI products are not authorized for use in safety-critical applications (such as life support) where a failure of the TI product would reasonably be expected to cause severe personal injury or death, unless officers of the parties have executed an agreement specifically governing such use. Buyers represent that they have all necessary expertise in the safety and regulatory ramifications of their applications, and acknowledge and agree that they are solely responsible for all legal, regulatory and safety-related requirements concerning their products and any use of TI products in such safety-critical applications, notwithstanding any applications-related information or support that may be provided by TI. Further, Buyers must fully indemnify TI and its representatives against any damages arising out of the use of TI products in such safety-critical applications.

TI products are neither designed nor intended for use in military/aerospace applications or environments unless the TI products are specifically designated by TI as military-grade or "enhanced plastic." Only products designated by TI as military-grade meet military specifications. Buyers acknowledge and agree that any such use of TI products which TI has not designated as military-grade is solely at the Buyer's risk, and that they are solely responsible for compliance with all legal and regulatory requirements in connection with such use.

TI products are neither designed nor intended for use in automotive applications or environments unless the specific TI products are designated by TI as compliant with ISO/TS 16949 requirements. Buyers acknowledge and agree that, if they use any non-designated products in automotive applications, TI will not be responsible for any failure to meet such requirements.

Following are URLs where you can obtain information on other Texas Instruments products and application solutions:

Products

Amplifiers	amplifier.ti.com
Data Converters	dataconverter.ti.com
DSP	dsp.ti.com
Clocks and Timers	www.ti.com/clocks
Interface	interface.ti.com
Logic	logic.ti.com
Power Mgmt	power.ti.com
Microcontrollers	microcontroller.ti.com
RFID	www.ti-rfid.com
RF/IF and ZigBee® Solutions	www.ti.com/lprf

Applications

Audio	www.ti.com/audio
Automotive	www.ti.com/automotive
Broadband	www.ti.com/broadband
Digital Control	www.ti.com/digitalcontrol
Medical	www.ti.com/medical
Military	www.ti.com/military
Optical Networking	www.ti.com/opticalnetwork
Security	www.ti.com/security
Telephony	www.ti.com/telephony
Video & Imaging	www.ti.com/video
Wireless	www.ti.com/wireless

Mailing Address: Texas Instruments, Post Office Box 655303, Dallas, Texas 75265
Copyright © 2008, Texas Instruments Incorporated