

# Thyristor

$$V_{RRM} = 1400 \text{ V}$$

$$I_{TAV} = 50 \text{ A}$$

$$V_T = 1,2 \text{ V}$$

AC Controlling  
1~ full-controlled

Part number

**MMO90-14io6**

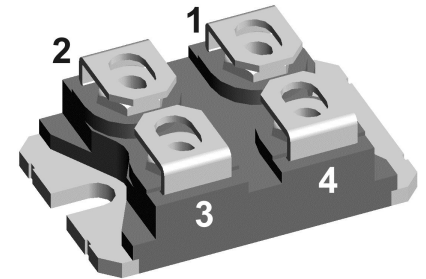

Backside: isolated

 E72873

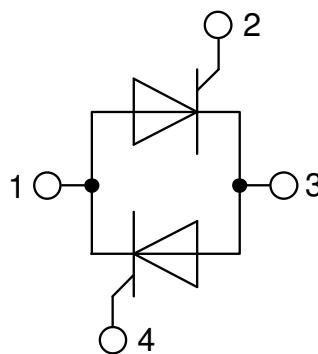

### Features / Advantages:

- Thyristor for line frequency
- Planar passivated chip
- Long-term stability

### Applications:

- Line rectifying 50/60 Hz
- Softstart AC motor control
- DC Motor control
- Power converter
- AC power control
- Lighting and temperature control

### Package: SOT-227B (minibloc)

- Isolation Voltage: 3000 V~
- Industry standard outline
- RoHS compliant
- Epoxy meets UL 94V-0
- Base plate: Copper internally DCB isolated
- Advanced power cycling

### Terms Conditions of usage:

The data contained in this product data sheet is exclusively intended for technically trained staff. The user will have to evaluate the suitability of the product for the intended application and the completeness of the product data with respect to his application. The specifications of our components may not be considered as an assurance of component characteristics. The information in the valid application- and assembly notes must be considered. Should you require product information in excess of the data given in this product data sheet or which concerns the specific application of your product, please contact the sales office, which is responsible for you.

Due to technical requirements our product may contain dangerous substances. For information on the types in question please contact the sales office, which is responsible for you.

Should you intend to use the product in aviation, in health or live endangering or life support applications, please notify. For any such application we urgently recommend

- to perform joint risk and quality assessments;

- the conclusion of quality agreements;

- to establish joint measures of an ongoing product survey, and that we may make delivery dependent on the realization of any such measures.

| Thyristor      |  |   | Ratings                   |      |      |                   |
|----------------|--|---|---------------------------|------|------|-------------------|
| Symbol         | Definition   | Conditions  | min.                      | typ. | max. | Unit              |
| $V_{RSM/DSM}$  | max. non-repetitive reverse/forward blocking voltage | $T_{VJ} = 25^{\circ}C$  |                           |      | 1500 | V                 |
| $V_{RRM/DRM}$  | max. repetitive reverse/forward blocking voltage     | $T_{VJ} = 25^{\circ}C$  |                           |      | 1400 | V                 |
| $I_{RD}$       | reverse current, drain current                       | $V_{R/D} = 1400 V$  | $T_{VJ} = 25^{\circ}C$    |      | 100  | $\mu A$           |
|                |  | $V_{R/D} = 1400 V$  | $T_{VJ} = 125^{\circ}C$   |      | 10   | mA                |
| $V_T$          | forward voltage drop                                 | $I_T = 50 A$  | $T_{VJ} = 25^{\circ}C$    |      | 1,27 | V                 |
|                |  | $I_T = 100 A$   |                           |      | 1,53 | V                 |
|                |  | $I_T = 50 A$  | $T_{VJ} = 150^{\circ}C$   |      | 1,20 | V                 |
|                |  | $I_T = 100 A$   |                           |      | 1,50 | V                 |
| $I_{TAV}$      | average forward current                              | $T_C = 95^{\circ}C$   | $T_{VJ} = 150^{\circ}C$   |      | 50   | A                 |
| $I_{RMS}$      | RMS forward current per phase                        | 180° sine   |                           |      | 110  | A                 |
| $V_{T0}$       | threshold voltage                                    | } for power loss calculation only   | $T_{VJ} = 150^{\circ}C$   |      | 0,88 | V                 |
| $r_T$          | slope resistance                                     |   |                           |      | 6    | m $\Omega$        |
| $R_{thJC}$     | thermal resistance junction to case                  |   |                           |      | 0,6  | K/W               |
| $R_{thCH}$     | thermal resistance case to heatsink                  |   |                           | 0,10 |      | K/W               |
| $P_{tot}$      | total power dissipation                              |   | $T_C = 25^{\circ}C$       |      | 210  | W                 |
| $I_{TSM}$      | max. forward surge current                           | $t = 10 ms; (50 Hz), sine$  | $T_{VJ} = 45^{\circ}C$    |      | 800  | A                 |
|                |  | $t = 8,3 ms; (60 Hz), sine$   | $V_R = 0 V$               |      | 865  | A                 |
|                |  | $t = 10 ms; (50 Hz), sine$  | $T_{VJ} = 150^{\circ}C$   |      | 680  | A                 |
|                |  | $t = 8,3 ms; (60 Hz), sine$   | $V_R = 0 V$               |      | 735  | A                 |
| $I^2t$         | value for fusing                                     | $t = 10 ms; (50 Hz), sine$  | $T_{VJ} = 45^{\circ}C$    |      | 3,20 | kA <sup>2</sup> s |
|                |  | $t = 8,3 ms; (60 Hz), sine$   | $V_R = 0 V$               |      | 3,12 | kA <sup>2</sup> s |
|                |  | $t = 10 ms; (50 Hz), sine$  | $T_{VJ} = 150^{\circ}C$   |      | 2,31 | kA <sup>2</sup> s |
|                |  | $t = 8,3 ms; (60 Hz), sine$   | $V_R = 0 V$               |      | 2,25 | kA <sup>2</sup> s |
| $C_J$          | junction capacitance                                 | $V_R = 400 V \quad f = 1 MHz$   | $T_{VJ} = 25^{\circ}C$    |      | 32   | pF                |
| $P_{GM}$       | max. gate power dissipation                          | $t_p = 30 \mu s$  | $T_C = 150^{\circ}C$      |      | 10   | W                 |
|                |  | $t_p = 300 \mu s$   |                           |      | 5    | W                 |
| $P_{GAV}$      | average gate power dissipation                       |   |                           |      | 0,5  | W                 |
| $(di/dt)_{cr}$ | critical rate of rise of current                     | $T_{VJ} = 150^{\circ}C; f = 50 Hz$  | repetitive, $I_T = 150 A$ |      | 100  | A/ $\mu s$        |
|                |  | $t_p = 200 \mu s; di_G/dt = 0,3 A/\mu s;$<br>$I_G = 0,3 A; V = \frac{2}{3} V_{DRM}$                                       | non-repet., $I_T = 50 A$  |      | 500  | A/ $\mu s$        |
| $(dv/dt)_{cr}$ | critical rate of rise of voltage                     | $V = \frac{2}{3} V_{DRM}$<br>$R_{GK} = \infty; \text{method 1 (linear voltage rise)}$                                     | $T_{VJ} = 150^{\circ}C$   |      | 1000 | V/ $\mu s$        |
| $V_{GT}$       | gate trigger voltage                                 | $V_D = 6 V$   | $T_{VJ} = 25^{\circ}C$    |      | 1,5  | V                 |
|                |  |   | $T_{VJ} = -40^{\circ}C$   |      | 1,6  | V                 |
| $I_{GT}$       | gate trigger current                                 | $V_D = 6 V$   | $T_{VJ} = 25^{\circ}C$    |      | 100  | mA                |
|                |  |   | $T_{VJ} = -40^{\circ}C$   |      | 200  | mA                |
| $V_{GD}$       | gate non-trigger voltage                             | $V_D = \frac{2}{3} V_{DRM}$   | $T_{VJ} = 150^{\circ}C$   |      | 0,2  | V                 |
| $I_{GD}$       | gate non-trigger current                             |   |                           |      | 5    | mA                |
| $I_L$          | latching current                                     | $t_p = 10 \mu s$  | $T_{VJ} = 25^{\circ}C$    |      | 250  | mA                |
|                |  | $I_G = 0,3 A; di_G/dt = 0,3 A/\mu s$  |                           |      |      |                   |
| $I_H$          | holding current                                      | $V_D = 6 V \quad R_{GK} = \infty$   | $T_{VJ} = 25^{\circ}C$    |      | 100  | mA                |
| $t_{gd}$       | gate controlled delay time                           | $V_D = \frac{1}{2} V_{DRM}$   | $T_{VJ} = 25^{\circ}C$    |      | 2    | $\mu s$           |
|                |  | $I_G = 0,3 A; di_G/dt = 0,3 A/\mu s$  |                           |      |      |                   |
| $t_q$          | turn-off time  | $V_R = 100 V; I_T = 50 A; V = \frac{2}{3} V_{DRM}$<br>$di/dt = 10 A/\mu s \quad dv/dt = 15 V/\mu s \quad t_p = 200 \mu s$ | $T_{VJ} = 125^{\circ}C$   |      | 150  | $\mu s$           |

| Package SOT-227B (minibloc) |  |                      |                                     | Ratings |      |      |  |
|-----------------------------|--|----------------------|-------------------------------------|---------|------|------|--|
| Symbol                      | Definition   | Conditions           | min.                                | typ.    | max. | Unit |  |
| $I_{RMS}$                   | RMS current  | per terminal         |                                     |         | 150  | A    |  |
| $T_{VJ}$                    | virtual junction temperature                                 |                      | -40                                 |         | 150  | °C   |  |
| $T_{op}$                    | operation temperature  |                      | -40                                 |         | 125  | °C   |  |
| $T_{stg}$                   | storage temperature  |                      | -40                                 |         | 150  | °C   |  |
| <b>Weight</b>               |  |                      |                                     |         | 30   | g    |  |
| $M_D$                       | mounting torque  |                      | 1,1                                 |         | 1,5  | Nm   |  |
| $M_T$                       | terminal torque  |                      | 1,1                                 |         | 1,5  | Nm   |  |
| $d_{Spp/App}$               | creepage distance on surface   striking distance through air | terminal to terminal | 10,5                                | 3,2     |      | mm   |  |
| $d_{Spb/Apb}$               |  | terminal to backside | 8,6                                 | 6,8     |      | mm   |  |
| $V_{ISOL}$                  | isolation voltage  | t = 1 second         | 50/60 Hz, RMS; $I_{ISOL} \leq 1$ mA | 3000    |      | V    |  |
|                             |  | t = 1 minute         |                                     | 2500    |      | V    |  |

### Product Marking

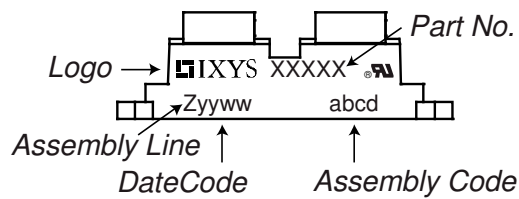

| Ordering | Ordering Number | Marking on Product | Delivery Mode | Quantity | Code No. |
|----------|-----------------|--------------------|---------------|----------|----------|
| Standard | MMO90-14io6     | MMO90-14io6        | Tube          | 10       | 485144   |

### Equivalent Circuits for Simulation

\* on die level

$T_{VJ} = 150$  °C

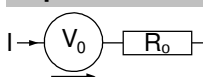

Thyristor

|              |                    |      |    |
|--------------|--------------------|------|----|
| $V_{0\ max}$ | threshold voltage  | 0,88 | V  |
| $R_{0\ max}$ | slope resistance * | 4,2  | mΩ |

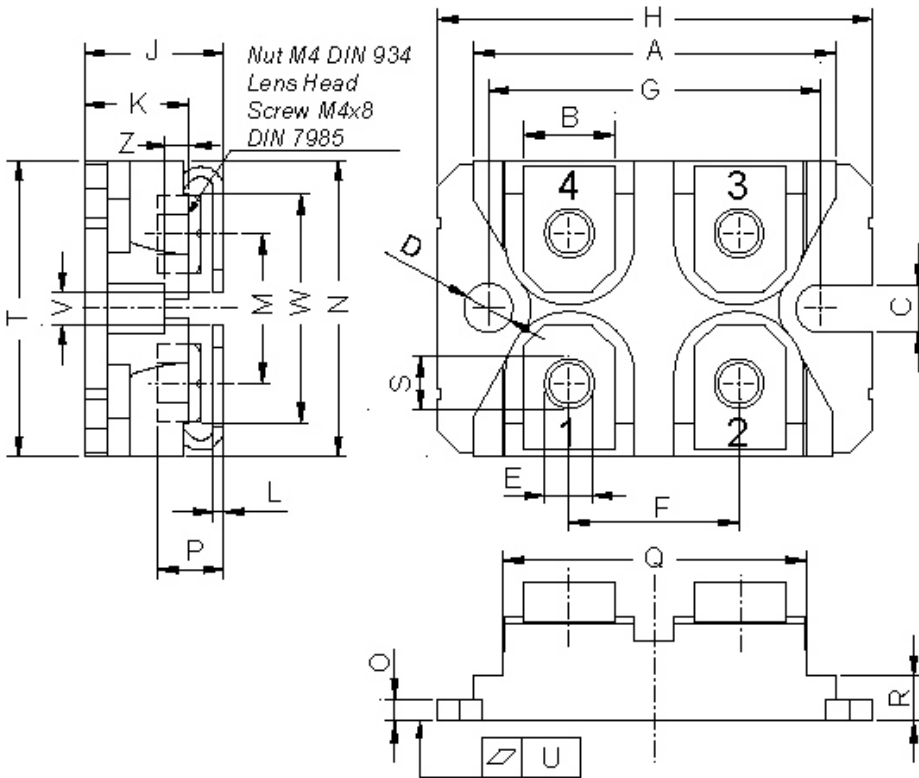
**Outlines SOT-227B (minibloc)**

| Dim. | Millimeter |       | Inches |       |
|------|------------|-------|--------|-------|
|      | min        | max   | min    | max   |
| A    | 31.50      | 31.88 | 1.240  | 1.255 |
| B    | 7.80       | 8.20  | 0.307  | 0.323 |
| C    | 4.09       | 4.29  | 0.161  | 0.169 |
| D    | 4.09       | 4.29  | 0.161  | 0.169 |
| E    | 4.09       | 4.29  | 0.161  | 0.169 |
| F    | 14.91      | 15.11 | 0.587  | 0.595 |
| G    | 30.12      | 30.30 | 1.186  | 1.193 |
| H    | 37.80      | 38.23 | 1.488  | 1.505 |
| J    | 11.68      | 12.22 | 0.460  | 0.481 |
| K    | 8.92       | 9.60  | 0.351  | 0.378 |
| L    | 0.74       | 0.84  | 0.029  | 0.033 |
| M    | 12.50      | 13.10 | 0.492  | 0.516 |
| N    | 25.15      | 25.42 | 0.990  | 1.001 |
| O    | 1.95       | 2.13  | 0.077  | 0.084 |
| P    | 4.95       | 6.20  | 0.195  | 0.244 |
| Q    | 26.54      | 26.90 | 1.045  | 1.059 |
| R    | 3.94       | 4.42  | 0.155  | 0.167 |
| S    | 4.55       | 4.85  | 0.179  | 0.191 |
| T    | 24.59      | 25.25 | 0.968  | 0.994 |
| U    | -0.05      | 0.10  | -0.002 | 0.004 |
| V    | 3.20       | 5.50  | 0.126  | 0.217 |
| W    | 19.81      | 21.08 | 0.780  | 0.830 |
| Z    | 2.50       | 2.70  | 0.098  | 0.106 |

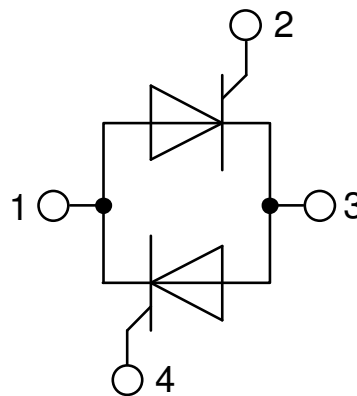

**Thyristor**

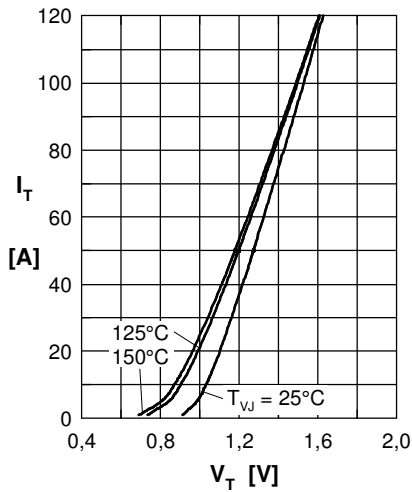

Fig. 1 Forward characteristics

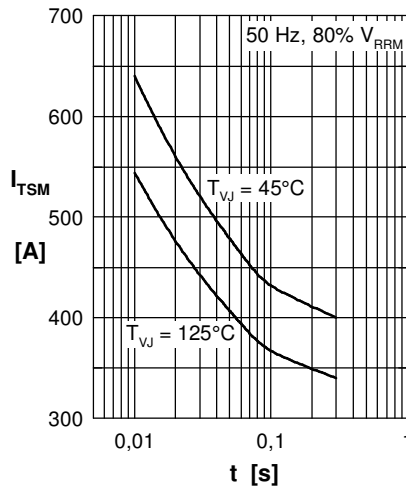

Fig. 2 Surge overload current

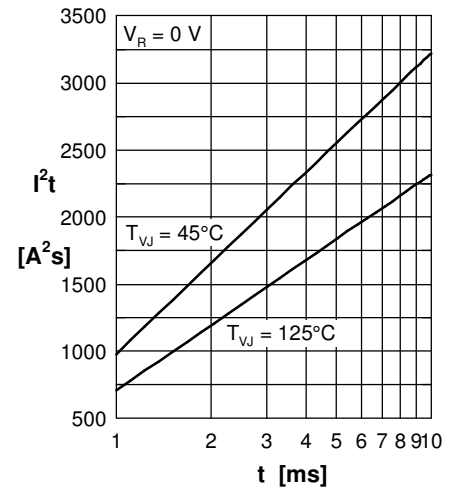

Fig. 3  $I^2t$  versus time (1-10 ms)

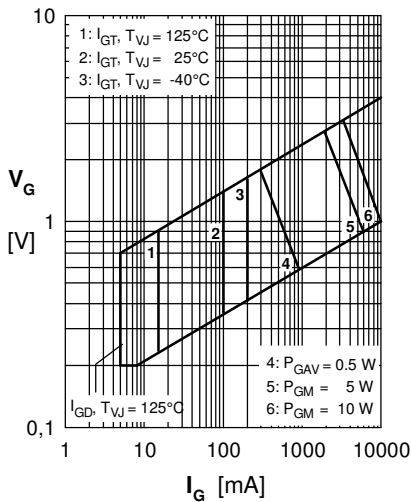

Fig. 4 Gate trigger characteristics

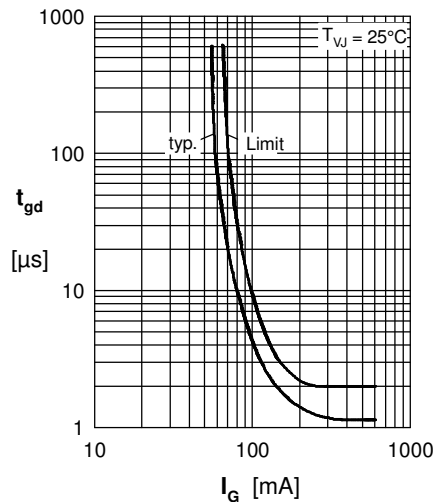

Fig. 5 Gate controlled delay time

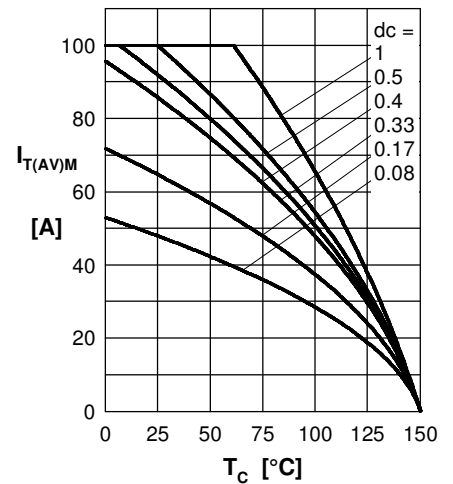

Fig. 6 Max. forward current at case temperature

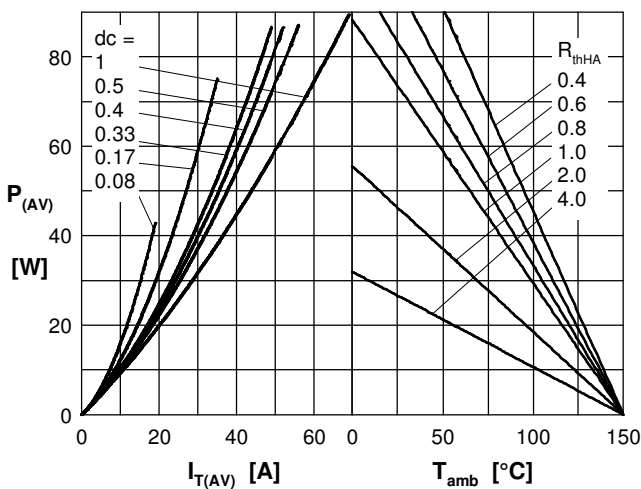

Fig. 7a Power dissipation versus direct output current  
Fig. 7b and ambient temperature

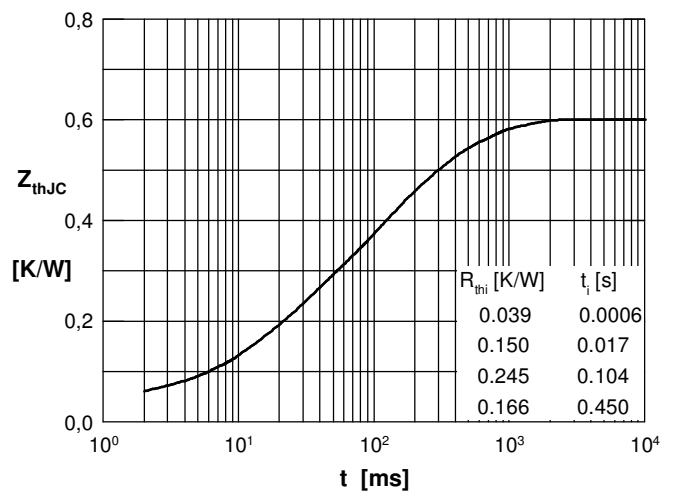

Fig. 8 Transient thermal impedance junction to case