IRU3073 EVALUATION BOARD USER GUIDE**INTRODUCTION**

The IRU3073 controller IC is designed to provide a low cost synchronous Buck regulator for on-board DC to DC converter for multiple output applications.

The outputs can be programmed as low as 0.8V for low voltage applications.

Selectable over-current protection is provided by using external MOSFET's on-resistance for optimum cost and performance.

This device features a programmable frequency set from 200KHz to 400KHz, under-voltage lockout for all input supplies, an external programmable soft-start function as well as output under-voltage detection that latches off the device when an output short is detected.

SPECIFICATION DATA

Switcher:	Linear	Supply Voltage:
$V_{IN} = 5V$	Regulator:	$V_{CC} = V_C = 12V$
$V_{OUT1} = 2.5V$	$V_{IN} = 2.5V$	
$I_{OUT1} = 8A$	(from switch)	
$\Delta V_{OUT} = 50mV$	$V_{OUT2} = 1.6V$	
$F_S = 200KHz$	$I_{OUT2} = 2A$	

INPUT/OUTPUT CONNECTIONS

The following is the input/output connections:

Inputs:

JP3: Input (+5V), Gnd

JP1: Input (+12V)

Outputs:

JP4: V_{OUT1} (+2.5V), Gnd

JP2: V_{OUT2} (+1.6V), Gnd

The connection points is shown in Figure 1. Connect the power supply cables according to this figure, minimize wire lengths to reduce losses in the wire. Test point J1 provides easy connections for the oscilloscope voltage probe to monitor the output voltage.

Note: For proper operation, +5V supply should ramp up first.

CONNECTION DIAGRAM

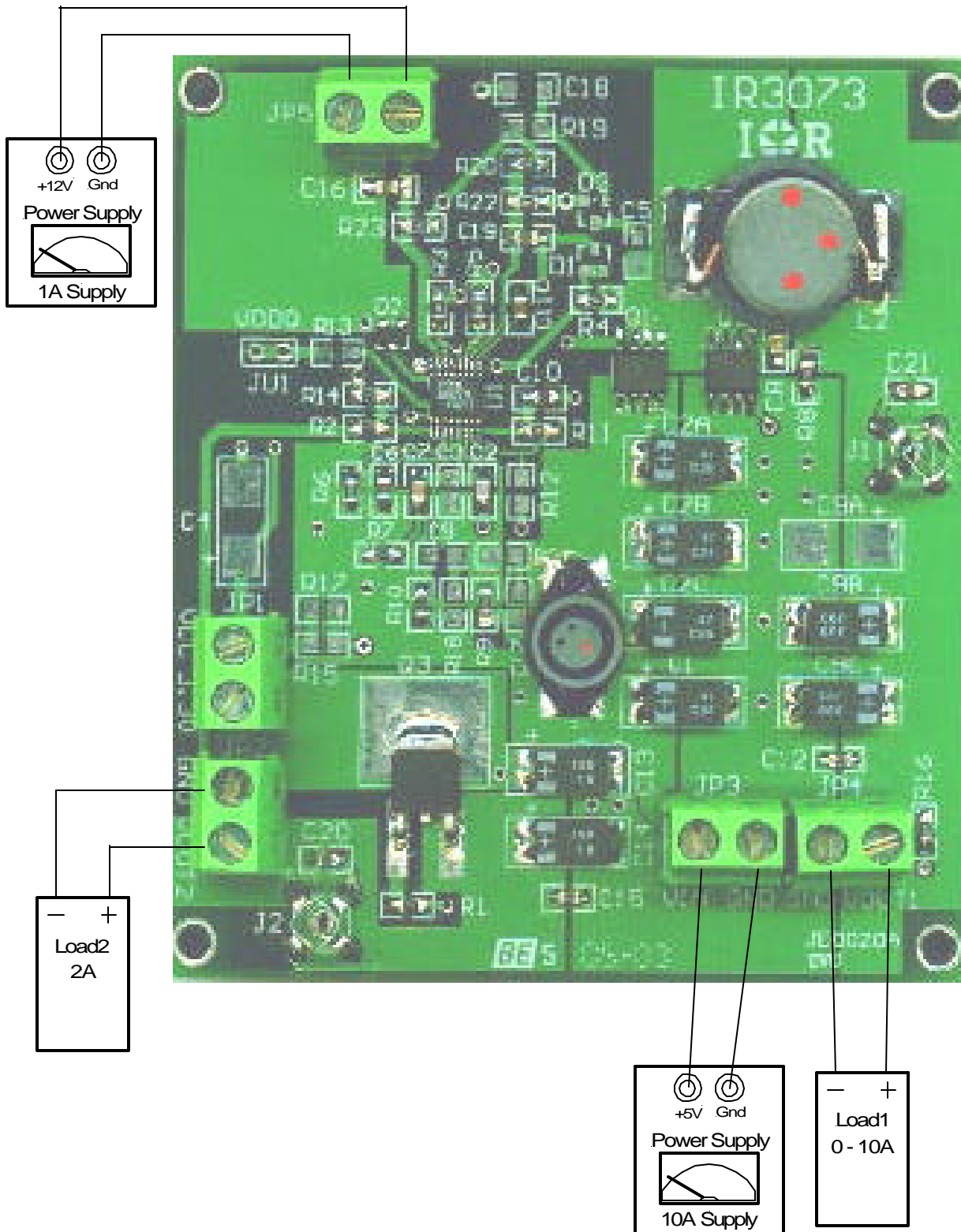

Figure 1 - Connection diagram of evaluation-board for IRU3073.

LAYOUT

The four layers for IRU3073 evaluation board are shown in Figures 2.1-2.4. The layout is designed both for direct FET package and SOIC package for power MOSFETs. The input capacitors are all located close to the MOSFETs. All the decoupling capacitors and feedback components are located close to IC. The feedback re-

sistors are tied to the output voltage at the point of regulation.

The middle layers are dedicated to Power Ground and Analog Ground. Analog Ground is kept separated from the Power Ground and it is connected at a single point as shown in figure 2.3.

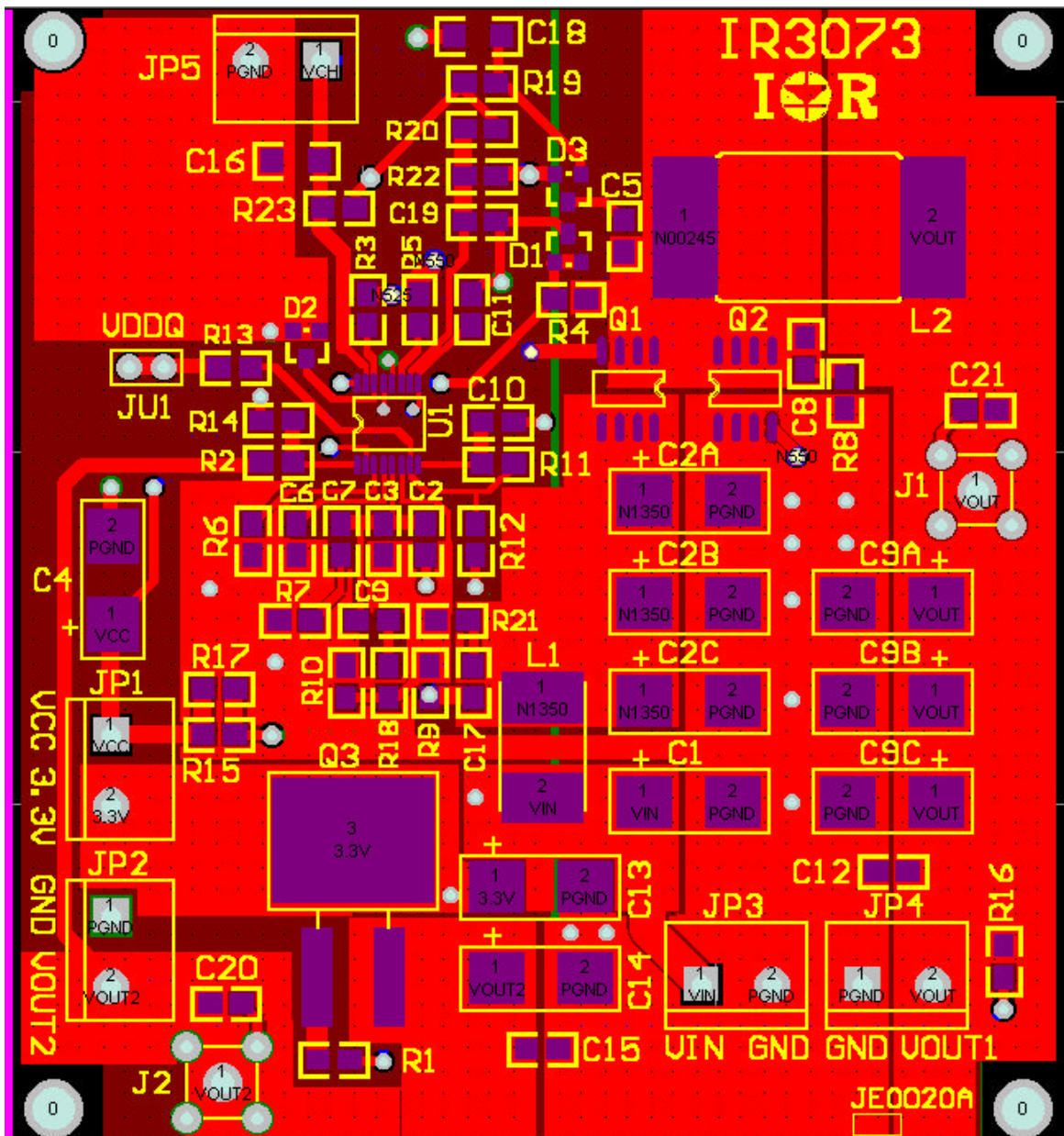

Figure 2.1 - Top layer of evaluation-board for IRU3073.

LAYOUT

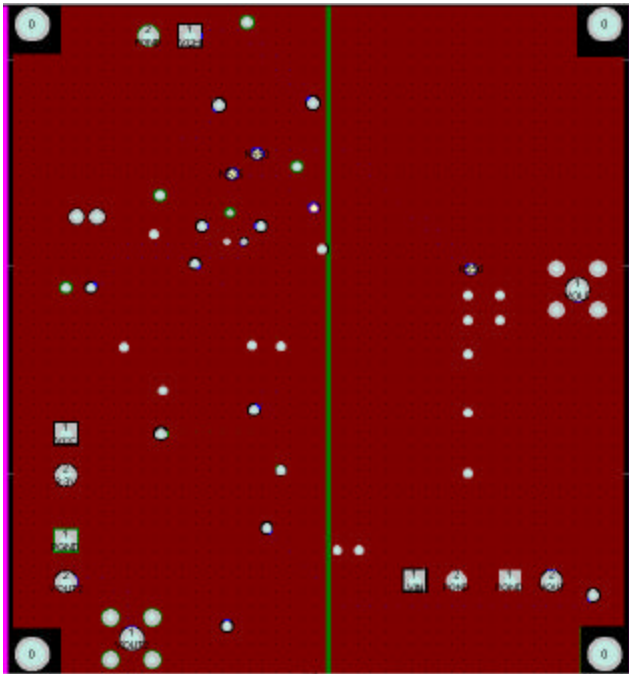

Figure 2.2 - Middle layer 1.

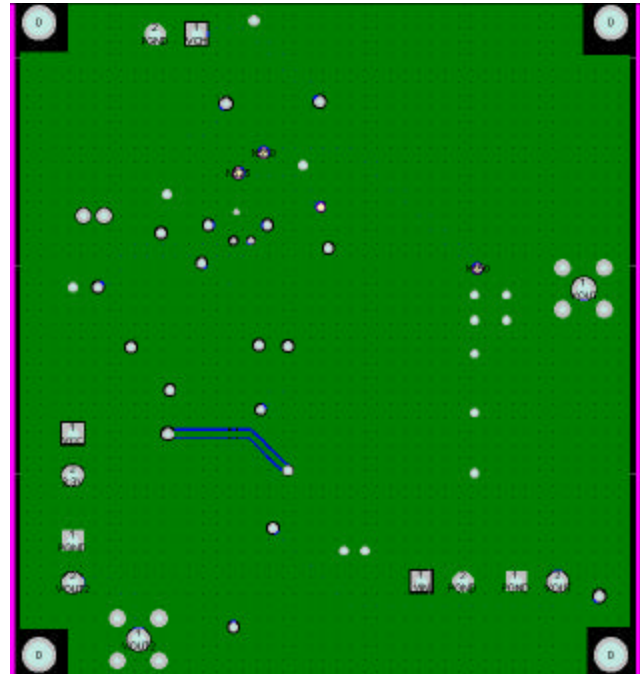

Figure 2.3 - Middle layer 2.

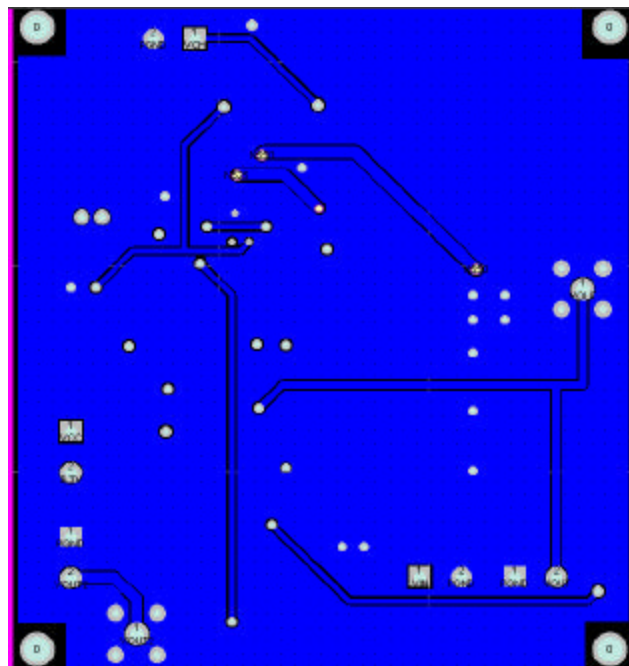

Figure 2.4 - Bottom layer.

SCHEMATIC

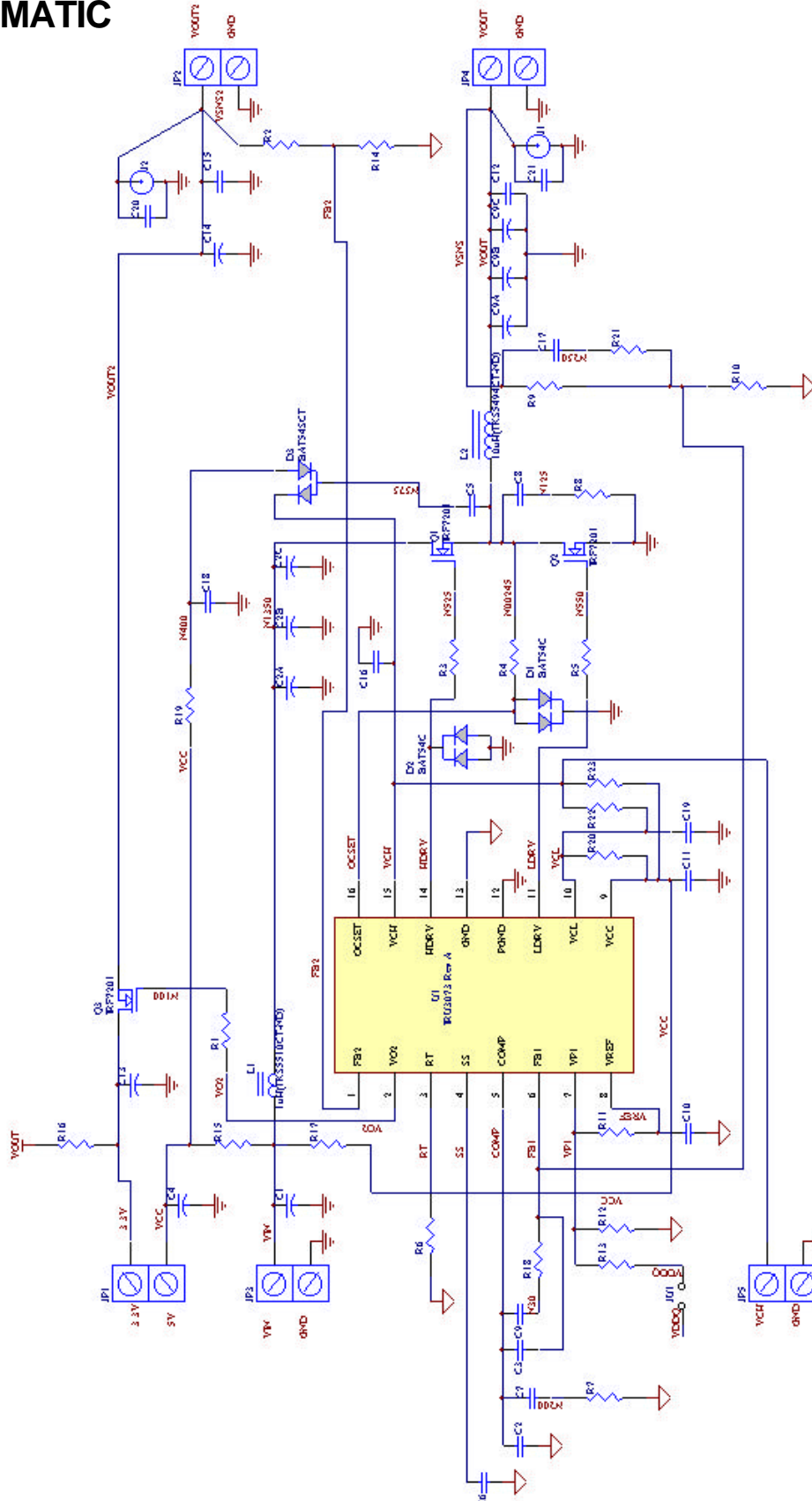

Figure 3 - Schematic of evaluation-board for IRU3073.

BILL OF MATERIAL

Ref Desig	Description	Value	Qty	Part#	Manuf	Web site (www.)
Q1,Q2	MOSFET		2	IRF7832	IR	irf.com
Q3	MOSFET		1	IRLR2703	IR	
U1	Controller		1	IRU3073CQ	IR	
D2	Schottky Diode		1	BAT54	IR	
L1	Inductor	1 μ H, 5.6A	1	DO3316P-102	Coilcraft	coilcraft.com
L2	Inductor	3.3 μ H, 17A	1	DO5022P-332HC	Coilcraft	
C1,C2A,B,C	Cap, Poscap	47 μ F, 16V	4	16TPB47M	Sanyo	sanyo.com
C2	Cap, Ceramic	33pF, NPO, 5%	1	ECU-V1H330JCV	Panasonic	maco.panasonic.co.jp
C6,C10	Cap, Ceramic	0.1 μ F, Y5V, 25V	2	ECJ-2VF1E104	Panasonic	
C7	Cap, Ceramic	2200pF, X7R, 50V	1	ECU-V1H222KBV	Panasonic	
C8	Cap, Ceramic	470pF, X7R, 50V	1	ECJ-2VC1H471J	Panasonic	
C9B,C	Cap, Poscap	330 μ F, 40m Ω	2	6TPB330M	Sanyo	sanyo.com
C11,12,15, 16,19,20,21	Cap, Ceramic	1 μ F, Y5V, 16V	7	ECJ-2VF1C1O5Z	Panasonic	maco.panasonic.co.jp
C13,C14	Cap, Poscap	150 μ F, 6.3V	2	6TPB150M	Sanyo	sanyo.com
R1	Resistor	10 Ω	1		Any	
R2,10,14	Resistor	1K, 1%	3		Any	
R3,5,11,16, 20,22,23	Resistor	0 Ω	7		Any Any	
R4	Resistor	5.1K, 1%	1		Any	
R6	Resistor	100K	1		Any	
R7	Resistor	24K, 1%	1		Any	
R8	Resistor	4.7 Ω , 1%	1		Any	
R9	Resistor	2.15K, 1%	1		Any	
R12,13,15, 17,18,19,21	Resistor	NA (Open)	7			
C3,4,5,9,17	Capacitor	NA (Open)	5			
D1,D3	Diode	NA (Open)	2			
JP1,2,3,4,5	Connector	2-Pos Terminal	5	ED1973-ND	Digikey	
J1,J2	Scope Probe		2	131-5031-00	Tetronix	
Circuit Board Spacer	Spacer	Bumpon	4	SJ-67A3 Black	3M	

TYPICAL OPERATING CHARACTERISTICS

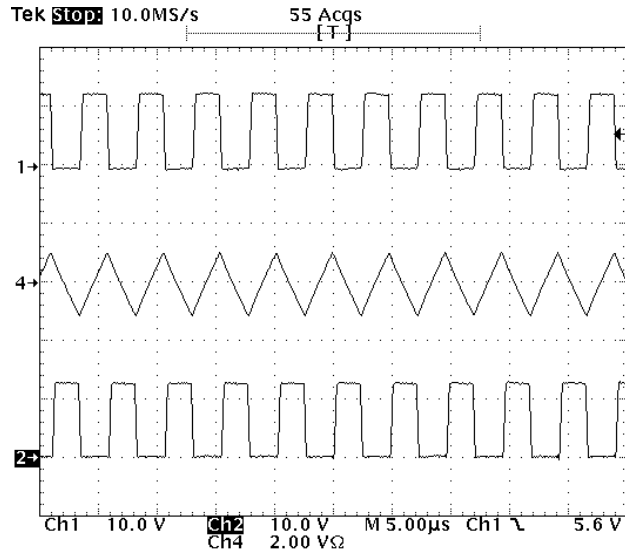

Figure 1 - Normal condition at no load.
 Ch1: HDrv
 Ch2: LDrv
 Ch4: Inductor Current

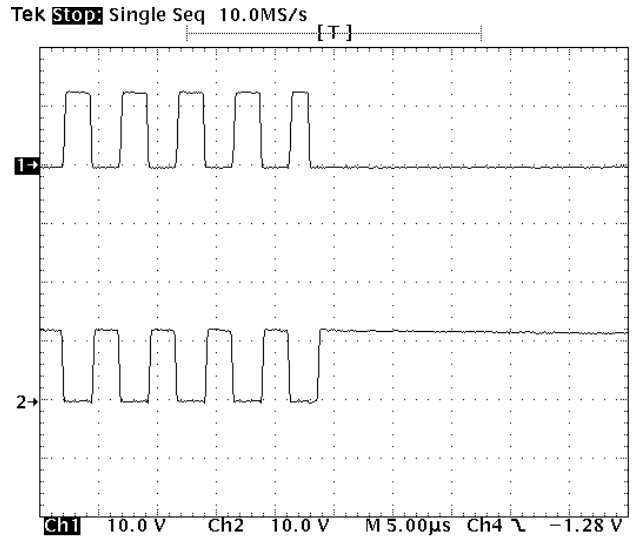

Figure 3 - Gate signals when SS pin pulls low.
 Ch1: HDrv
 Ch2: LDrv

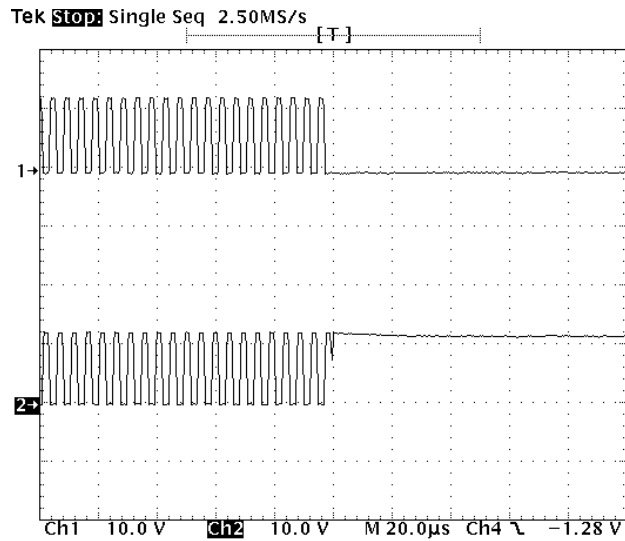

Figure 2 - Gate signals when SS pin pulls low.
 Ch1: HDrv
 Ch2: LDrv

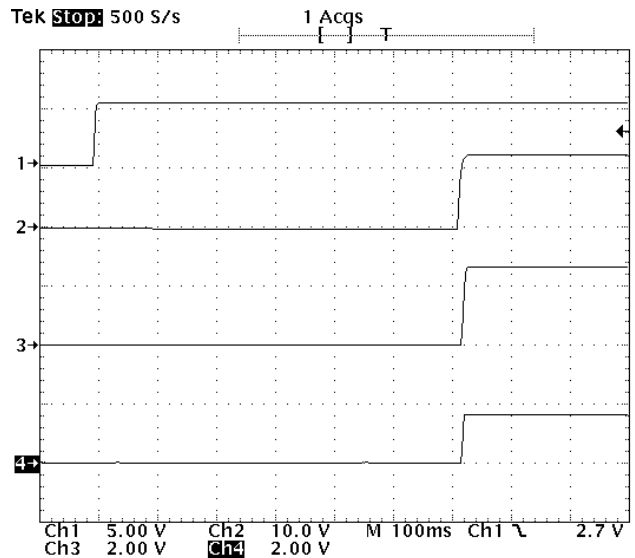

Figure 4 - Soft-Start.
 Ch1: V_{IN} (5V)
 Ch2: Bias Voltage (12V)
 Ch3: V_{OUT}
 Ch4: I_{OUT}

TYPICAL OPERATING CHARACTERISTICS

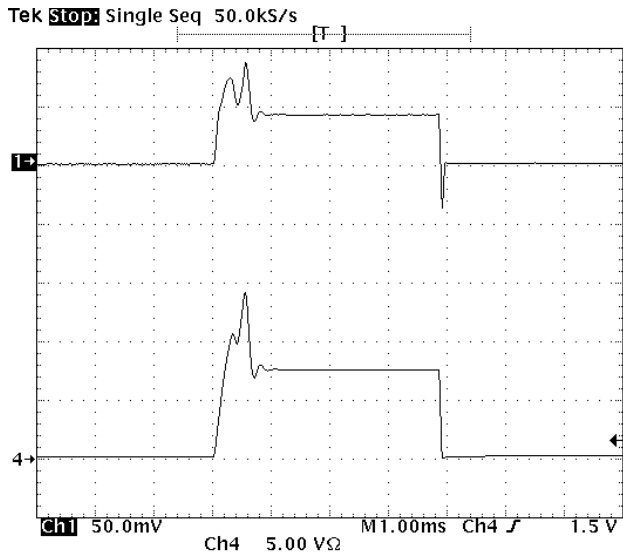

Figure 6 - Output Shorted at start-up.
 Ch1: V_{OUT}
 Ch2: I_{OUT}

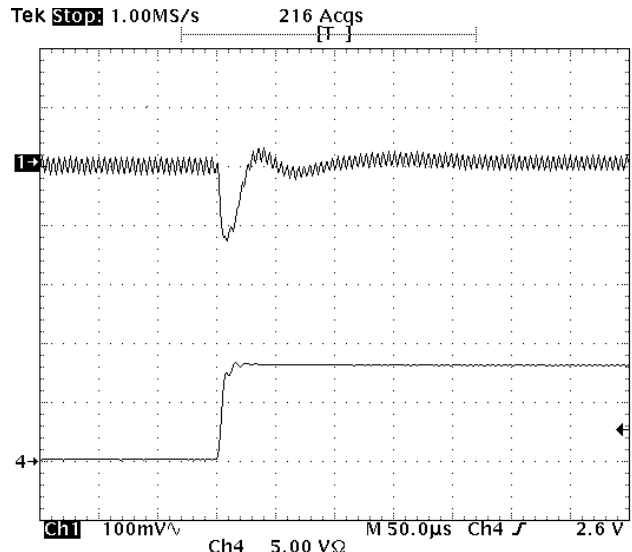

Figure 8 - Load Transient Response
 (PWM Section).

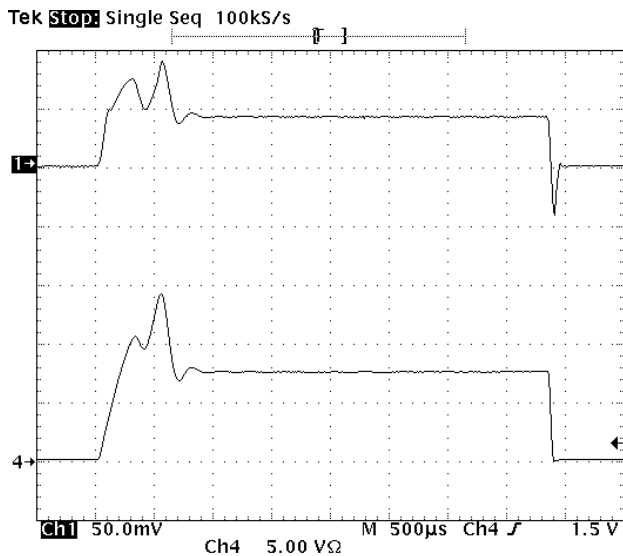

Figure 7 - Output Shorted at start-up.
 Ch1: V_{OUT}
 Ch2: I_{OUT}

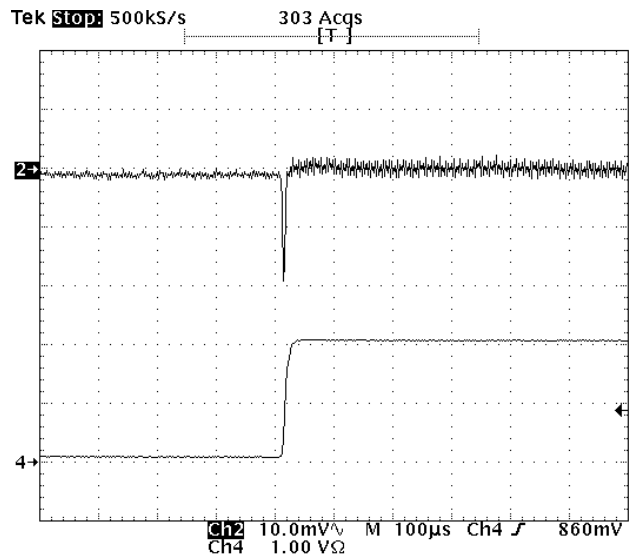

Figure 10 - Load Transient Response
 (PWM Section).