

ELM844xA 280µA Low power class-A output CMOS dual operational amplifier

http://www.elm-tech.com

■ General description

ELM844xA is a low current consumption-Typ.280µA CMOS dual OP-AMP provided with a wide common mode input voltage range. It has a quasi rail-to-rail input stage and a class-A rail-to-rail output stage. ELM844xA can operate down to 1.2V. ELM844xA is suitable for portable devices which require low power and a single voltage source.

■ Features

- Operation from a single power source
- Low voltage operation : $1.2V \leq V_{dd} \leq 6.0V$
- Low current consumption : Typ.260µA($V_{dd}=1.5V$)
- N-channel depletion differential input
 - : No gm dependence on input operating points
- Common-mode input voltage range
 - : Quasi rail-to-rail input
 - 0.08V to $V_{dd}-0.05V$ ($V_{dd}=1.5V$)
 - 0.04V to $V_{dd}-0.1V$ ($V_{dd}=3.0V$)
- Output stage : 90µA Class A rail-to-rail output
- Unity gain bandwidth : Typ.1MHz($V_{dd} \geq 1.5V$)
- Package : SOT-28, SOP-8, TSSOP-8

■ Application

- Battery-operated portable devices
- Signal process in low power circuit
- Low voltage analog circuit

■ Maximum absolute ratings

Parameter	Symbol	Limit	Unit
Power supply voltage	V _{dd}	7.0	V
Input voltage	V _{in}	V _{ss} -0.3 to V _{dd} +0.3	V
Output voltage	V _{out}	V _{ss} -0.3 to V _{dd} +0.3	V
Output short circuit		Continuous	Sec.
Power dissipation	P _d	300	mW
Operating temperature	T _{op}	-40 to +85	°C
Storage temperature	T _{stg}	-55 to +125	°C

■ Selection guide

ELM844xA-x

Symbol		
a	Package	B: SOT-28 D: SOP-8 E: TSSOP-8
b	Product version	A
c	Taping direction	S: Refer to PKG file N: Refer to PKG file

ELM844 x A - x
 ↑ ↑ ↑
 a b c

ELM844xA 280µA Low power class-A output CMOS dual operational amplifier

<http://www.elm-tech.com>

■ Pin configuration

SOT-28(TOP VIEW)

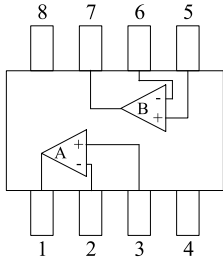

SOP-8(TOP VIEW)

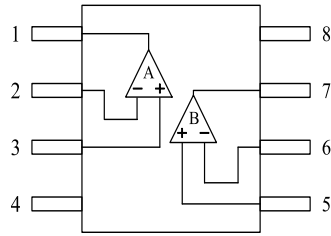

TSSOP-8(TOP VIEW)

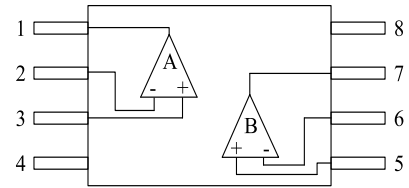

Pin No.	Pin name	Pin No.	Pin name
1	OUTA	5	IN+B
2	IN-A	6	IN-B
3	IN+A	7	OUTB
4	VSS	8	VDD

■ Standard circuit

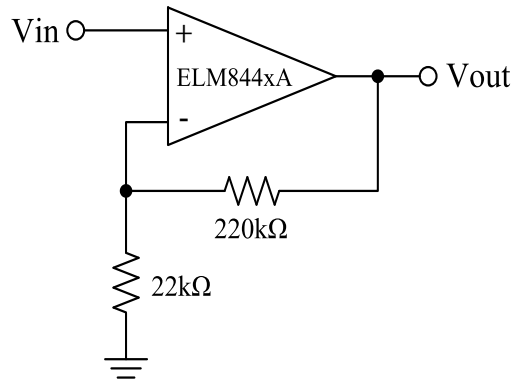

■ Marking

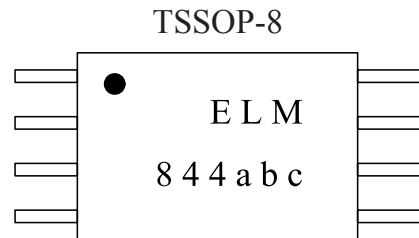
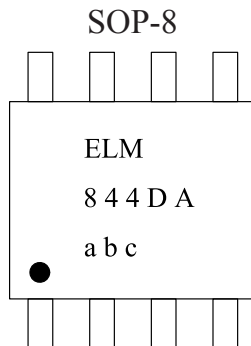
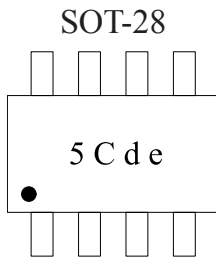

Symbol	Mark	Content
a	0 to 9	Last numeral of A.D.
b	A to M (excepted I.)	Assembly month
c	0 to 9	Lot No.
d	0 to 9 and A to Z (I, O, X excepted.)	
e		

ELM844xA 280 μ A Low power class-A output CMOS dual operational amplifier

<http://www.elm-tech.com>

■Electrical characteristics

V_{ss}=0V, Top=-40~+85°C

Parameter	Symbol	Condition	Min.	Typ.	Max.	Unit
Operating voltage	V _{dd}		1.2		6.0	V

V_{dd}=1.5V

V_{ss}=0V, Top=25°C

Parameter	Symbol	Condition	Min.	Typ.	Max.	Unit
Input offset voltage	V _{io}	V _{cm} =V _{dd} /2, Unity gain follower			±6	mV
Input bias current	I _{ib}				1.0	nA
Common-mode input voltage range	V _{cmr}	For CMRR≥40dB	0.08		1.45	V
Maximum output voltage swing	V _{outsh}	V _{id} =100mV, R _L =200kΩ to V _{ss}	1.42			V
Minimum output voltage swing	V _{outsl}	V _{id} =100mV, R _L =10kΩ to V _{dd}			0.10	V
Source current	I _{source}	V _{out} =0.75V, V _{id} =100mV	40	90		μA
Sink current	I _{sink}	V _{out} =0.3V, V _{id} =100mV	1.0	2.5		mA
Large-signal voltage gain	A _{vd}	R _L =200kΩ to V _{ss} , V _{cm} =0.75V		110		dB
Common-mode rejection ratio	CMRR	R _L =200kΩ to V _{ss} , V _{cm} =0.75V		90		dB
Supply voltage rejection ratio	PSRR	R _L =200kΩ to V _{ss} , V _{cm} =0.75V		70		dB
Current consumption	I _{ss}	V _{cm} =V _{dd} /2, Unity gain follower		260	620	μA
Short current	I _{shortp}	V _{out} to V _{ss} shrot, V _{id} =100mV		100		μA
	I _{shortn}	V _{out} to V _{dd} shrot, V _{id} =100mV		4.0		mA
Unity gain bandwidth	GBW			1		MHz
Slew rate	SR	R _L =200kΩ, C _L =20pF	0.45	1.00		V/μs

V_{dd}=3.0V

V_{ss}=0V, Top=25°C

Parameter	Symbol	Condition	Min.	Typ.	Max.	Unit
Input offset voltage	V _{io}	V _{cm} =V _{dd} /2, Unity gain follower			±6	mV
Input bias current	I _{ib}				1.0	nA
Common-mode input voltage range	V _{cmr}	For CMRR≥40dB	0.04		2.90	V
Maximum output voltage swing	V _{outsh}	V _{id} =100mV, R _L =200kΩ to V _{ss}	2.80			V
Minimum output voltage swing	V _{outsl}	V _{id} =100mV, R _L =10kΩ to V _{dd}			0.10	V
Source current	I _{source}	V _{out} =1.5V, V _{id} =100mV	45	100		μA
Sink current	I _{sink}	V _{out} =0.3V, V _{id} =100mV	3.0	7.5		mA
Large-signal voltage gain	A _{vd}	R _L =200kΩ to V _{ss} , V _{cm} =1.5V		110		dB
Common-mode rejection ratio	CMRR	R _L =200kΩ to V _{ss} , V _{cm} =1.5V		110		dB
Supply voltage rejection ratio	PSRR	R _L =200kΩ to V _{ss} , V _{cm} =1.5V		100		dB
Current consumption	I _{ss}	V _{cm} =V _{dd} /2, Unity gain follower		280	720	μA
Short current	I _{shortp}	V _{out} to V _{ss} shrot, V _{id} =100mV		110		μA
	I _{shortn}	V _{out} to V _{dd} shrot, V _{id} =100mV		25		mA
Unity gain bandwidth	GBW			1		MHz
Slew rate	SR	R _L =200kΩ, C _L =20pF	0.45	1.00		V/μs

ELM844xA 280µA Low power class-A output CMOS dual operational amplifier

<http://www.elm-tech.com>

■Note

1) Load resistance

ELM844xA is designed for low power consumption applications; hence, the output source current is only 90µA (Typ. under the conditions of at $V_{dd}=1.5V$, $V_{out}=0.75V$ and $T_{op}=25^{\circ}C$). As a result, ELM844xA is not able to maintain output voltage swing when trying to drive small load resistance. Considering this, load and feedback resistance for ELM844xA should be selected carefully.

ELM recommends the following load/feedback resistors depending on power supply voltage range.

< Power supply voltage >		< total resistance value of load/feedback resistor >
$V_{dd} \leq 5.5V$:	$R \geq 250k\Omega$
$V_{dd} \leq 3.6V$:	$R \geq 200k\Omega$
$V_{dd} \leq 1.8V$:	$R \geq 150k\Omega$

2) Operation from single power source

ELM844xA is designed to be most suitable for single power source; therefore, ELM844xA is able to share power supply with logic circuit one. Meanwhile, ELM844xA can also operate from double power sources. To protect power supplies of ELM844xA and logic circuit from noise, please separate wire from power supply and use decoupling (bypass) capacitor. Using the capacitor can improve PSRR characteristics, especially on 10kHz to 100kHz or more.

3) Feedback

When OP-AMP circuit is used with feedback resistor, oscillation may happen in the circuit with loop-gain like unity gain follower.

a) When large feedback resistance is used, the phase margin is decreased by its combination with the parasitic capacitance of the input part of OP-AMP. In this situation, please connect small capacitor in parallel with feedback resistor as shown in fig-1.

b) For capacitive load, external resistor in series connection will be effective as shown in fig-2.
($R_L=300$ to 500Ω)

c) Being used as an unity gain follow, ELM844xA is able to drive capacitive load of 100pF directly without oscillation.

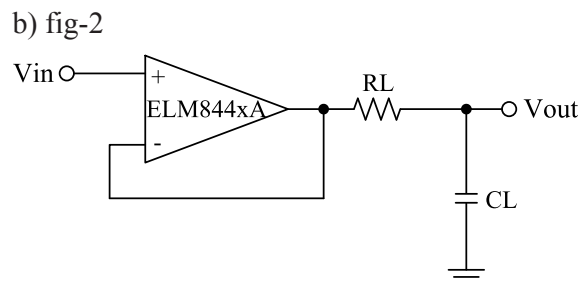
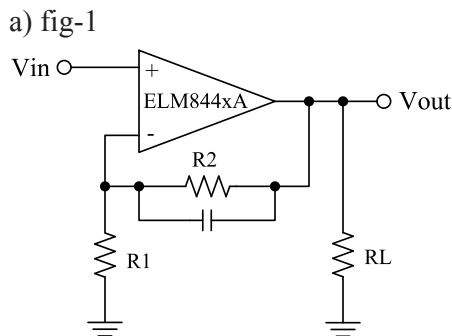

4) Operation at $V_{dd} < 1.2V$

ELM844xA is able to maintain operation when supply voltage is below 1.2V ($V_{dd} \geq 1.2V$) since all input voltage is acceptable within the range of power supply voltage. However, AC characteristics will become weak under this situation because of the decrease of bias current in the IC. For further information, please contact ELM.

5) Unused Amplifier

Two amplifiers will consume power even if only one amplifier is used.

In order to minimize power consumption by the unused amplifier, ELM recommends to connect this amplifier as voltage follower circuit and the input terminal (IN+) to V_{dd} .

ELM844xA 280 μ A Low power class-A output CMOS dual operational amplifier

<http://www.elm-tech.com>

■ Typical characteristics

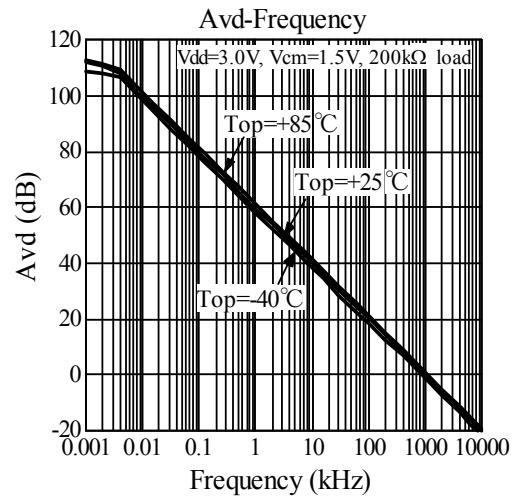
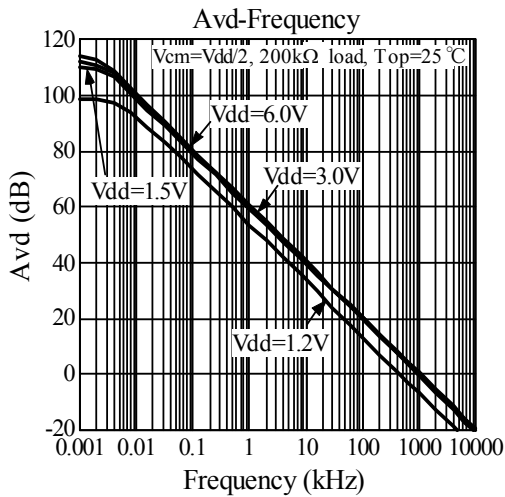
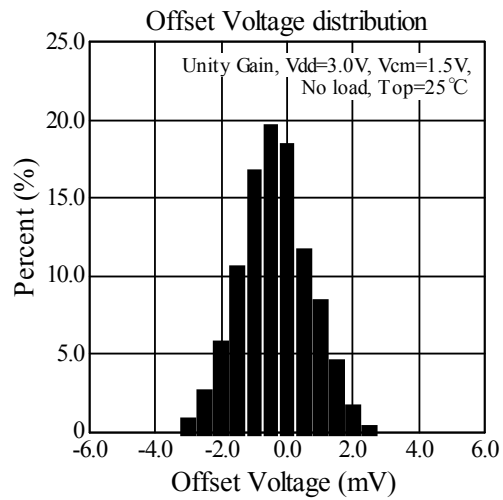
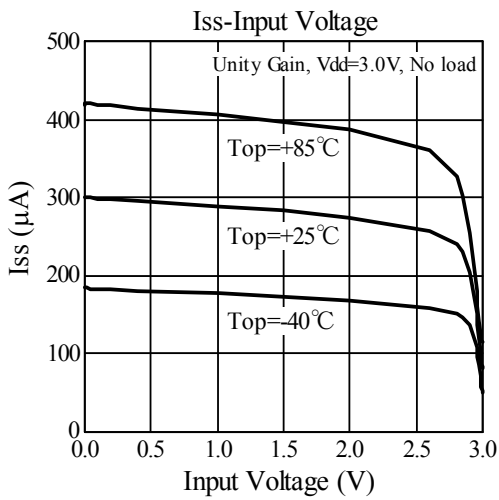
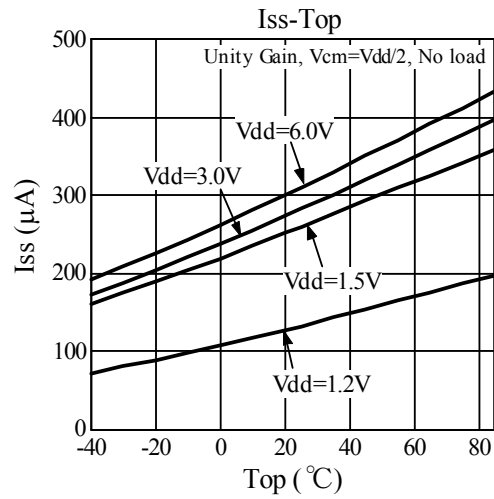
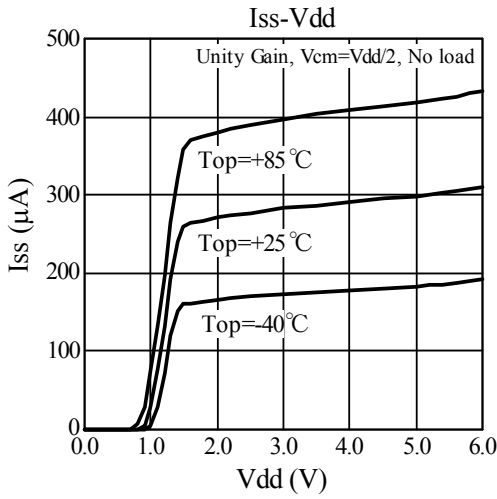

ELM844xA 280 μ A Low power class-A output CMOS dual operational amplifier

<http://www.elm-tech.com>

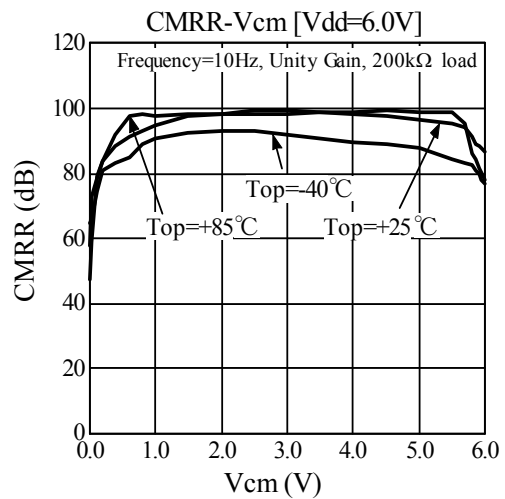
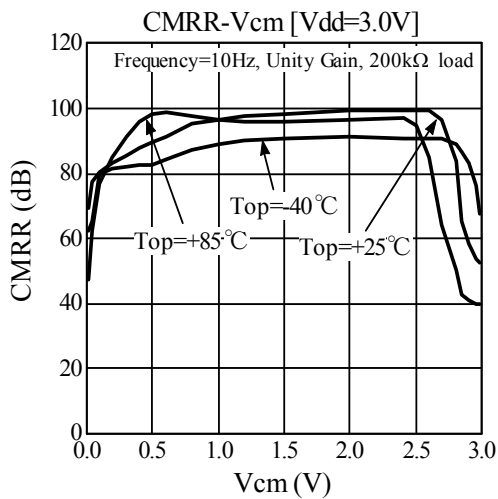
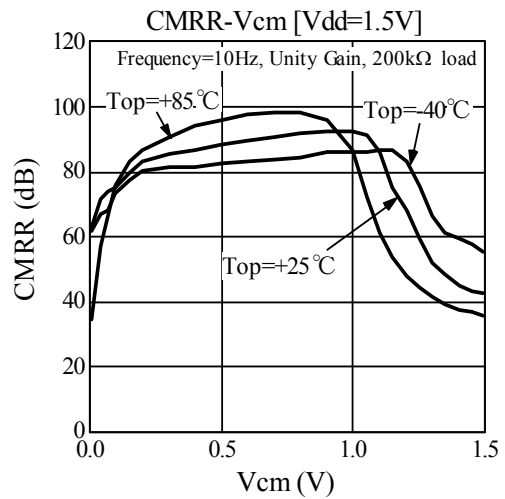
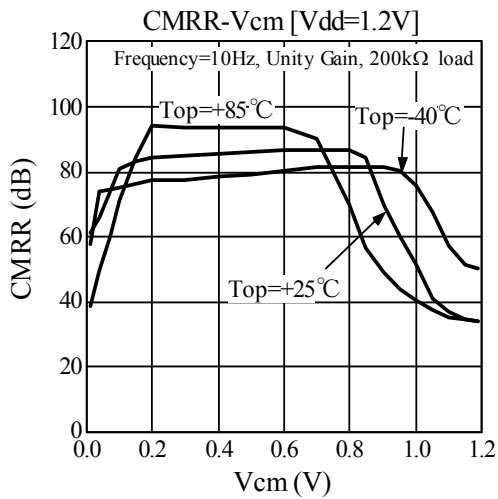
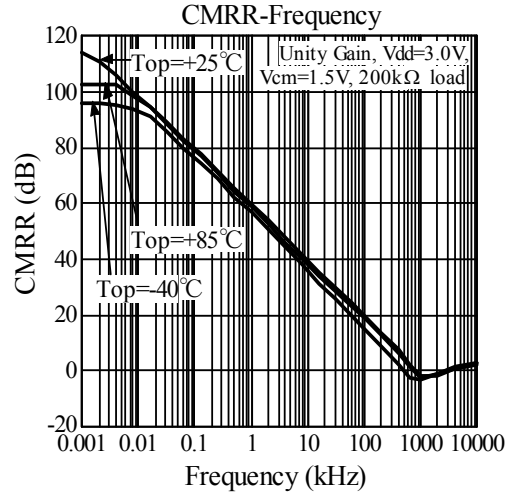
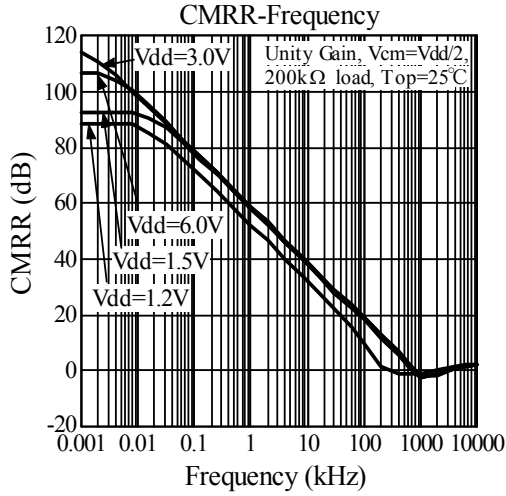

ELM844xA 280 μ A Low power class-A output CMOS dual operational amplifier

<http://www.elm-tech.com>

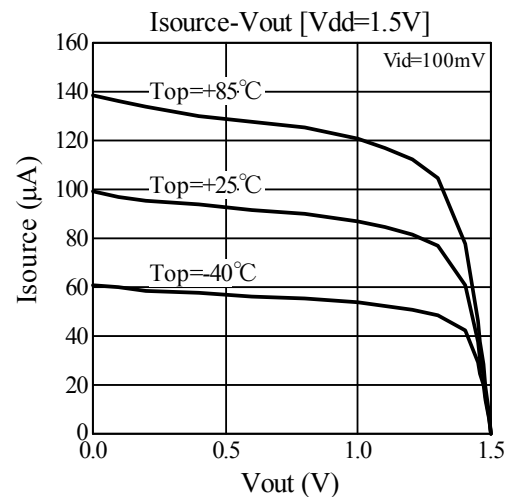
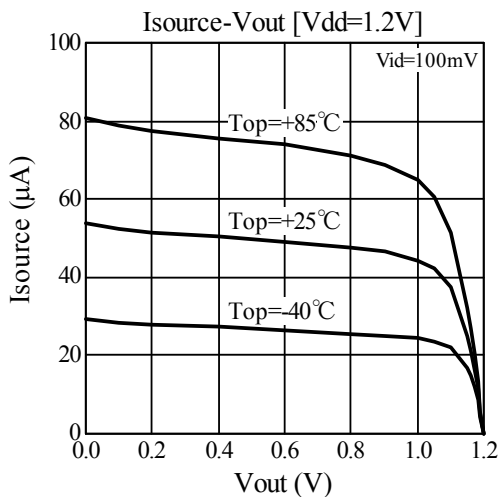
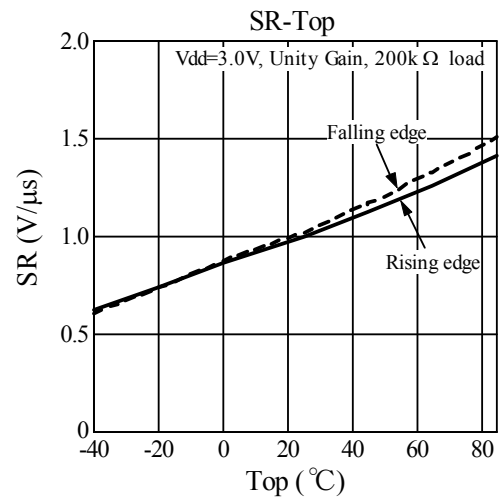
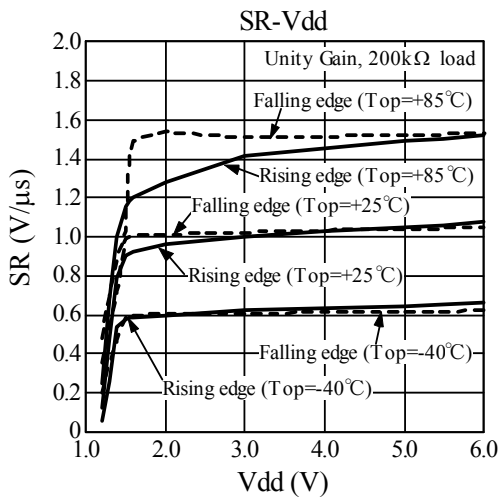
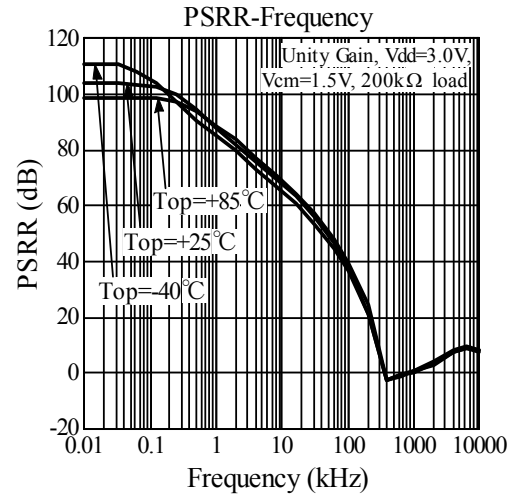
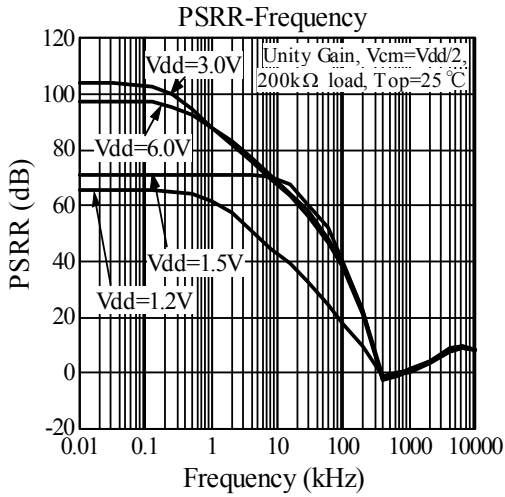

ELM844xA 280 μ A Low power class-A output CMOS dual operational amplifier

<http://www.elm-tech.com>

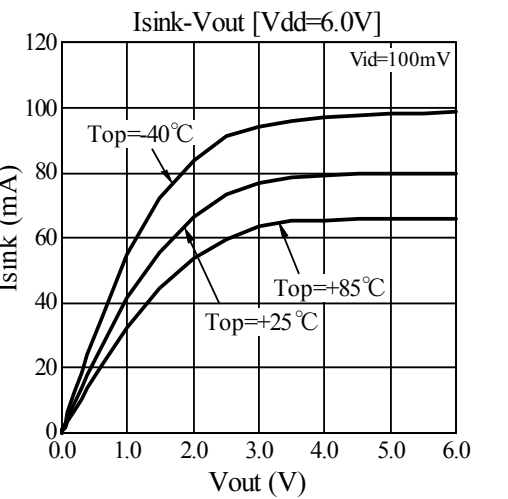
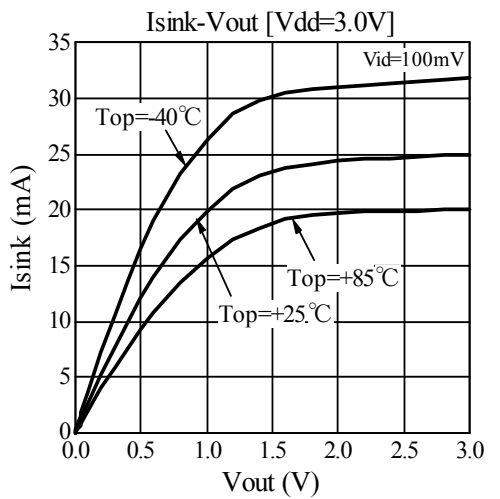
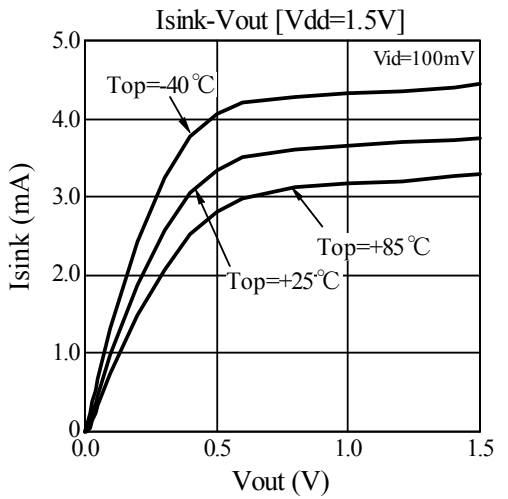
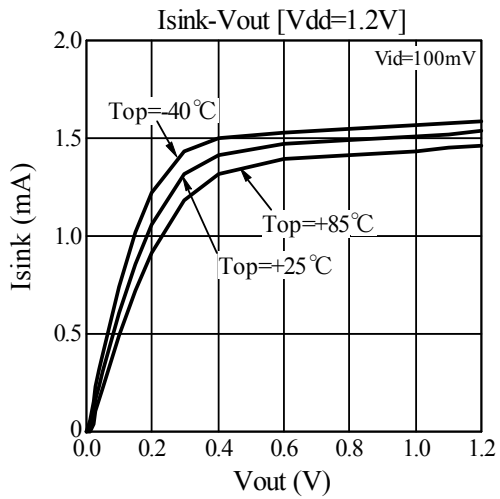
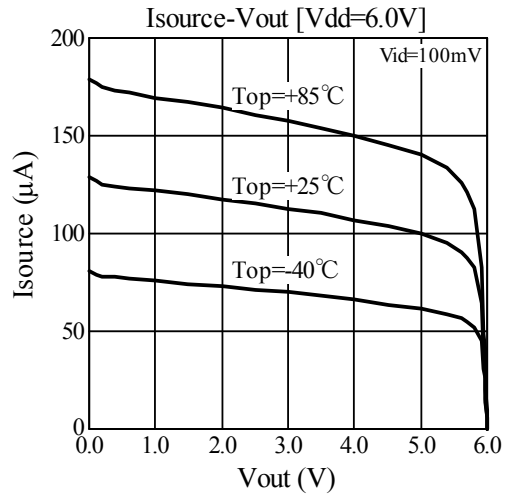
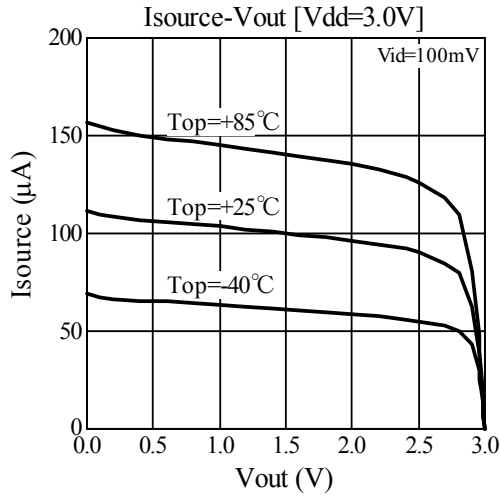

ELM844xA 280 μ A Low power class-A output CMOS dual operational amplifier

<http://www.elm-tech.com>

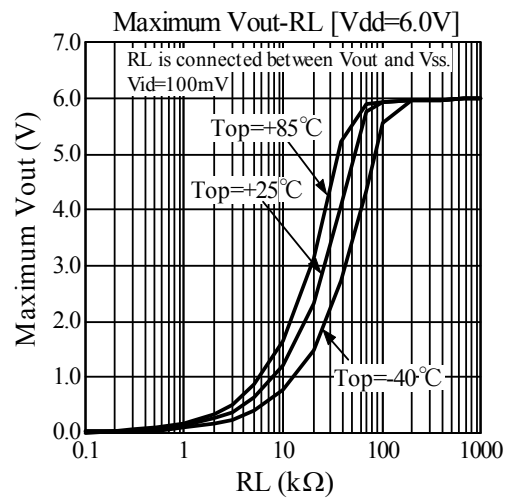
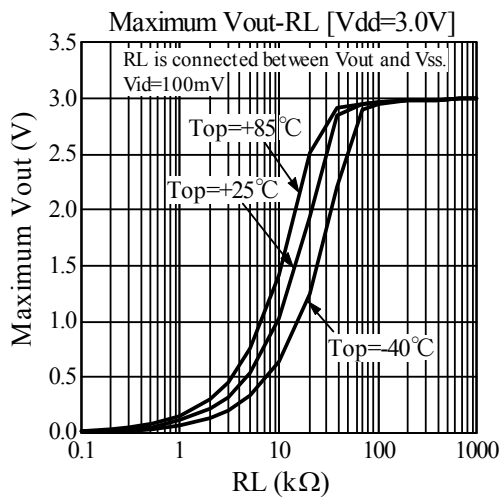
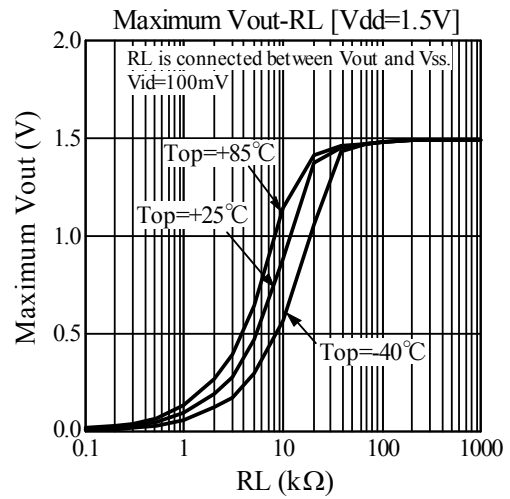
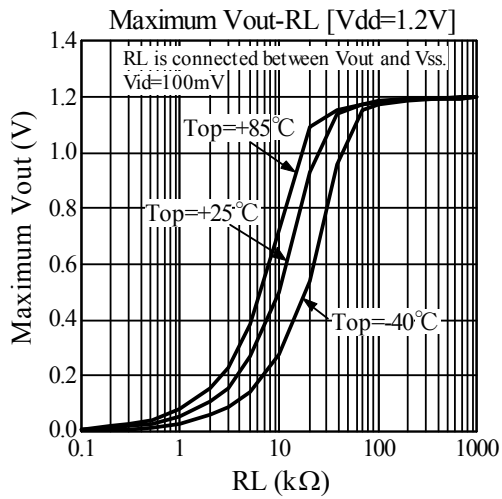
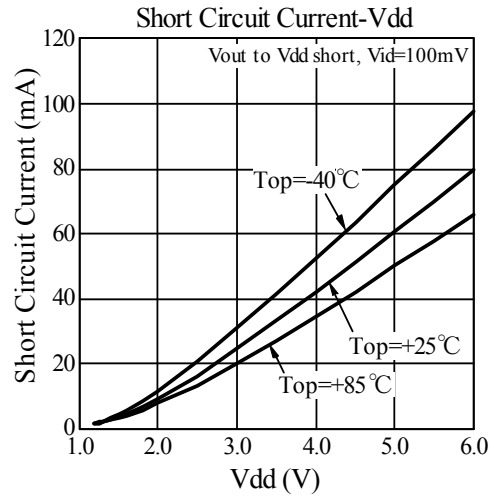
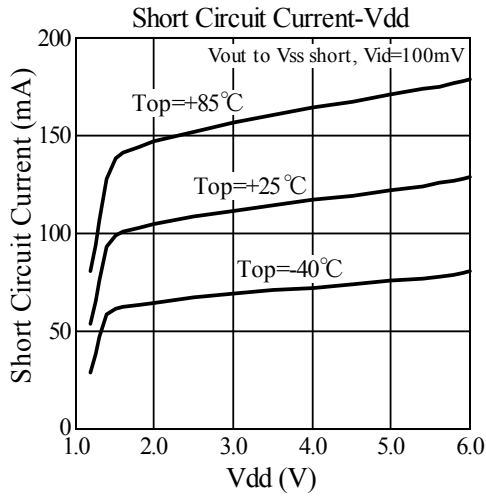

ELM844xA 280 μ A Low power class-A output CMOS dual operational amplifier

<http://www.elm-tech.com>

