

RF Power LDMOS Transistor

High Ruggedness N-Channel Enhancement-Mode Lateral MOSFET

Designed for handheld two-way radio applications with frequencies from 1.8 to 941 MHz. The high gain, ruggedness and wideband performance of this device make it ideal for large-signal, common-source amplifier applications in handheld radio equipment.

Wideband Performance (7.5 Vdc, T_A = 25°C, CW)

Frequency (MHz)	P _{in} (dBm)	G _{ps} (dB)	η _D (%)	P _{out} (W)
136–174 (1,4)	17.8	17.1	67.1	3.2
350–520 (2,4)	20.0	15.1	73.0	3.2

Narrowband Performance (7.5 Vdc, T_A = 25°C, CW)

Frequency (MHz)	G _{ps} (dB)	η _D (%)	P _{out} (W)
520 (3)	20.8	68.3	3.0

Load Mismatch/Ruggedness

Frequency (MHz)	Signal Type	VSWR	P _{in} (dBm)	Test Voltage	Result
520 (3)	CW	> 65:1 at all Phase Angles	21.1	9.0	No Device Degradation

1. Measured in 136–174 MHz VHF broadband reference circuit.
2. Measured in 350–520 MHz UHF broadband reference circuit.
3. Measured in 520 MHz narrowband production test circuit.
4. The values shown are the center band performance numbers across the indicated frequency range.

Features

- Characterized for Operation from 1.8 to 941 MHz
- Unmatched Input and Output Allowing Wide Frequency Range Utilization
- Integrated ESD Protection
- Integrated Stability Enhancements
- Wideband — Full Power Across the Band
- Exceptional Thermal Performance
- Extreme Ruggedness

Typical Applications

- Output Stage VHF Band Handheld Radio
- Output Stage UHF Band Handheld Radio
- Output Stage for 700–900 MHz Handheld Radio
- Smart Metering
- Driver for 1.8–941 MHz Applications

AFT05MS003N

**1.8–941 MHz, 3 W, 7.5 V
 WIDEBAND
 AIRFAST RF POWER
 LDMOS TRANSISTOR**



SOT-89

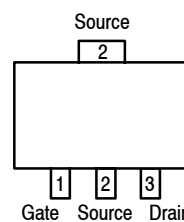

Figure 1. Pin Connections

Table 1. Maximum Ratings

Rating	Symbol	Value	Unit
Drain-Source Voltage	V_{DSS}	-0.5, +30	Vdc
Gate-Source Voltage	V_{GS}	-6.0, +12	Vdc
Operating Voltage	V_{DD}	12.5, +0	Vdc
Storage Temperature Range	T_{stg}	-65 to +150	°C
Case Operating Temperature Range	T_C	-40 to +150	°C
Operating Junction Temperature Range (1,2)	T_J	-40 to +150	°C
Total Device Dissipation @ $T_C = 25^\circ\text{C}$ Derate above 25°C	P_D	30.5 0.24	W W/°C

Table 2. Thermal Characteristics

Characteristic	Symbol	Value (2,3)	Unit
Thermal Resistance, Junction to Case Case Temperature 79°C, 3 W CW, 7.5 Vdc, $I_{DQ} = 100$ mA, 520 MHz	$R_{\theta JC}$	4.1	°C/W

Table 3. ESD Protection Characteristics

Test Methodology	Class
Human Body Model (per JESD22-A114)	1C, passes 1000 V
Machine Model (per EIA/JESD22-A115)	A, passes 100 V
Charge Device Model (per JESD22-C101)	IV, passes 2000 V

Table 4. Moisture Sensitivity Level

Test Methodology	Rating	Package Peak Temperature	Unit
Per JESD22-A113, IPC/JEDEC J-STD-020	1	260	°C

Table 5. Electrical Characteristics ($T_A = 25^\circ\text{C}$ unless otherwise noted)

Characteristic	Symbol	Min	Typ	Max	Unit
----------------	--------	-----	-----	-----	------

Off Characteristics

Zero Gate Voltage Drain Leakage Current ($V_{DS} = 30$ Vdc, $V_{GS} = 0$ Vdc)	I_{DSS}	—	—	2	μAdc
Zero Gate Voltage Drain Leakage Current ($V_{DS} = 7.5$ Vdc, $V_{GS} = 0$ Vdc)	I_{DSS}	—	—	1	μAdc
Gate-Source Leakage Current ($V_{GS} = 5$ Vdc, $V_{DS} = 0$ Vdc)	I_{GSS}	—	—	500	nAdc

On Characteristics

Gate Threshold Voltage ($V_{DS} = 10$ Vdc, $I_D = 67$ μAdc)	$V_{GS(th)}$	1.8	2.2	2.6	Vdc
Drain-Source On-Voltage ($V_{GS} = 10$ Vdc, $I_D = 700$ mAdc)	$V_{DS(on)}$	—	0.25	—	Vdc
Forward Transconductance ($V_{DS} = 7.5$ Vdc, $I_D = 2.6$ Adc)	g_{fs}	—	3.1	—	S

Dynamic Characteristics

Reverse Transfer Capacitance ($V_{DS} = 7.5$ Vdc ± 30 mV(rms)ac @ 1 MHz, $V_{GS} = 0$ Vdc)	C_{rss}	—	1.1	—	pF
Output Capacitance ($V_{DS} = 7.5$ Vdc ± 30 mV(rms)ac @ 1 MHz, $V_{GS} = 0$ Vdc)	C_{oss}	—	23.2	—	pF
Input Capacitance ($V_{DS} = 7.5$ Vdc, $V_{GS} = 0$ Vdc ± 30 mV(rms)ac @ 1 MHz)	C_{iss}	—	38.5	—	pF

1. Continuous use at maximum temperature will affect MTTF.
2. MTTF calculator available at <http://www.freescale.com/rf/calculators>.
3. Refer to [AN1955](#), *Thermal Measurement Methodology of RF Power Amplifiers*. Go to <http://www.freescale.com/rf> and search for AN1955.
(continued)

Table 5. Electrical Characteristics ($T_A = 25^\circ\text{C}$ unless otherwise noted) **(continued)**

Characteristic	Symbol	Min	Typ	Max	Unit
Typical Performance (In Freescale Narrowband Production Test Fixture, 50 ohm system) $V_{DD} = 7.5\text{ Vdc}$, $I_{DQ} = 100\text{ mA}$, $P_{in} = 13.95\text{ dBm}$, $f = 520\text{ MHz}$					
Common-Source Amplifier Output Power	P_{out}	—	3.0	—	W
Drain Efficiency	η_D	—	68.3	—	%

Load Mismatch/Ruggedness (In Freescale Narrowband Production Test Fixture, 50 ohm system) $I_{DQ} = 100\text{ mA}$

Frequency (MHz)	Signal Type	VSWR	P_{in} (dBm)	Test Voltage, V_{DD}	Result
520	CW	> 65:1 at all Phase Angles	21.1	9.0	No Device Degradation

Table 6. Ordering Information

Device	Tape and Reel Information	Package
AFT05MS003NT1	T1 Suffix = 1,000 Units, 12 mm Tape Width, 7-inch Reel	SOT-89

TYPICAL CHARACTERISTICS

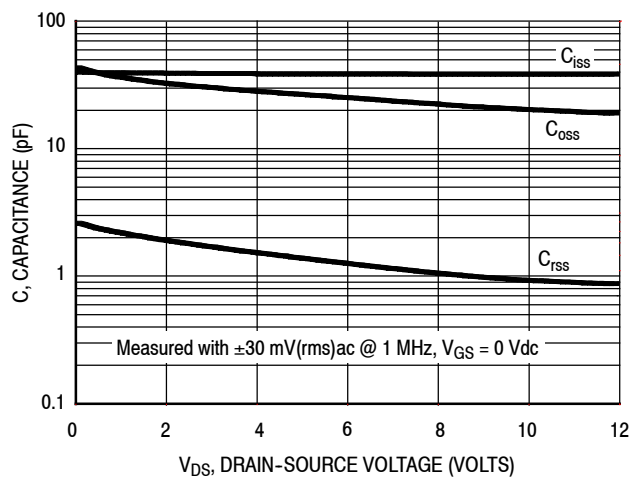
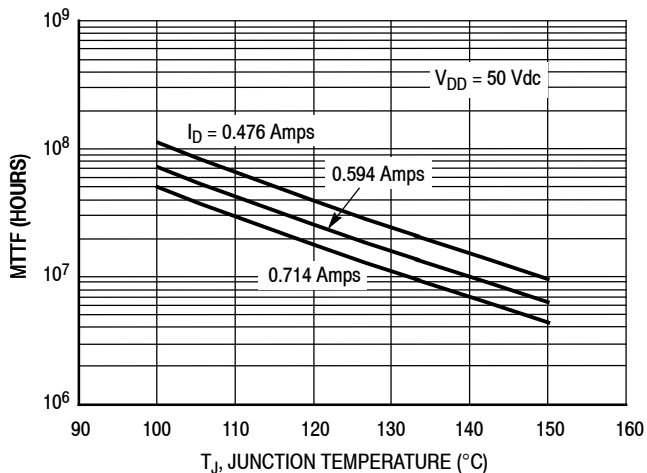

Figure 2. Capacitance versus Drain-Source Voltage



Note: MTTF value represents the total cumulative operating time under indicated test conditions.

MTTF calculator available at <http://www.freescale.com/rf/calculators>.

Figure 3. MTTF versus Junction Temperature — CW

136–174 MHz VHF BROADBAND REFERENCE CIRCUIT

Table 7. 136–174 MHz VHF Broadband Performance (In Freescale VHF Broadband Reference Circuit, 50 ohm system) $V_{DD} = 7.5$ Volts, $I_{DQ} = 60$ mA, $T_A = 25^\circ\text{C}$, CW

Frequency (MHz)	P_{in} (dBm)	G_{ps} (dB)	η_D (%)	P_{out} (W)
135	17.8	17.5	68.1	3.5
155	17.8	17.1	67.1	3.2
175	17.8	17.2	65.6	3.3

Table 8. Load Mismatch/Ruggedness (In Freescale VHF Broadband Reference Circuit)

Frequency (MHz)	Signal Type	VSWR	P_{in} (dBm)	Test Voltage, V_{DD}	Result
155	CW	> 65:1 at all Phase Angles	20.0	9.0	No Device Degradation

136–174 MHz VHF Broadband Reference Circuit — 0.83" × 1.86" (2.1 cm × 4.7 cm)

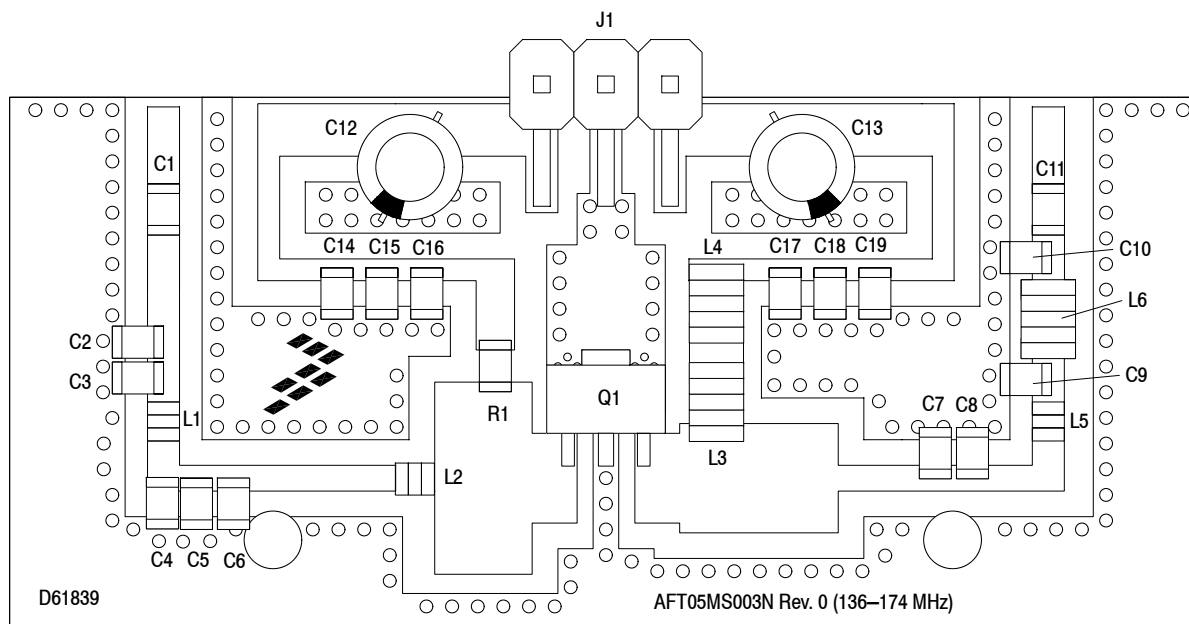

Figure 4. AFT05MS003N VHF Broadband Reference Circuit Component Layout — 136–174 MHz

Table 9. AFT05MS003N VHF Broadband Reference Circuit Component Designations and Values — 136–174 MHz

Part	Description	Part Number	Manufacturer
C1, C11	1500 pF Chip Capacitors	C2012X7R2A152K085AM	TDK
C2, C3, C4, C5, C8	56 pF Chip Capacitors	GQM2195C2E560GB12D	Murata
C6, C7	47 pF Chip Capacitors	GQM2195C2E470GB12D	Murata
C9	39 pF Chip Capacitor	GQM2195C2E390GB12D	Murata
C10	20 pF Chip Capacitor	GQM2195C2E200GB12D	Murata
C12, C13	10 μ F, 50 V Electrolytic Capacitors	UVR1H100MDD	Nichicon
C14, C19	1 μ F Chip Capacitors	GRM21BR71H105KA12L	Murata
C15, C18	1 nF Chip Capacitors	C2012X7R2E102M	TDK
C16, C17	100 pF Chip Capacitors	ATC600F101JT250XT	ATC
J1	Right-Angle Breakaway Headers (3 pins)	22-28-8360	Molex
L1	12.1 nH Inductor	0908SQ12N	Coilcraft
L2	11.2 nH Inductor	0807SQ11N	Coilcraft
L3, L4	25.0 nH Inductors	0908SQ25N	Coilcraft
L5	17.0 nH Inductor	0908SQ17N	Coilcraft
L6	23.0 nH Inductor	0908SQ23N	Coilcraft
Q1	RF Power LDMOS Transistor	AFT05MS003NT1	Freescale
R1	100 Ω , 1/4 W Chip Resistor	CRCW1206100RFKEA	Vishay
PCB	0.020", $\epsilon_r = 4.8$, FR4 (S-1000)	D61839	MTL

TYPICAL CHARACTERISTICS — 136–174 MHz VHF BROADBAND REFERENCE CIRCUIT

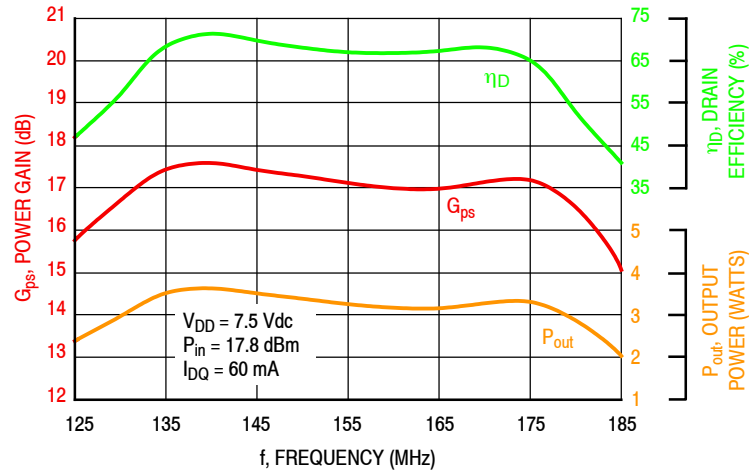

Figure 5. Power Gain, Drain Efficiency and Output Power versus Frequency at a Constant P_{in}

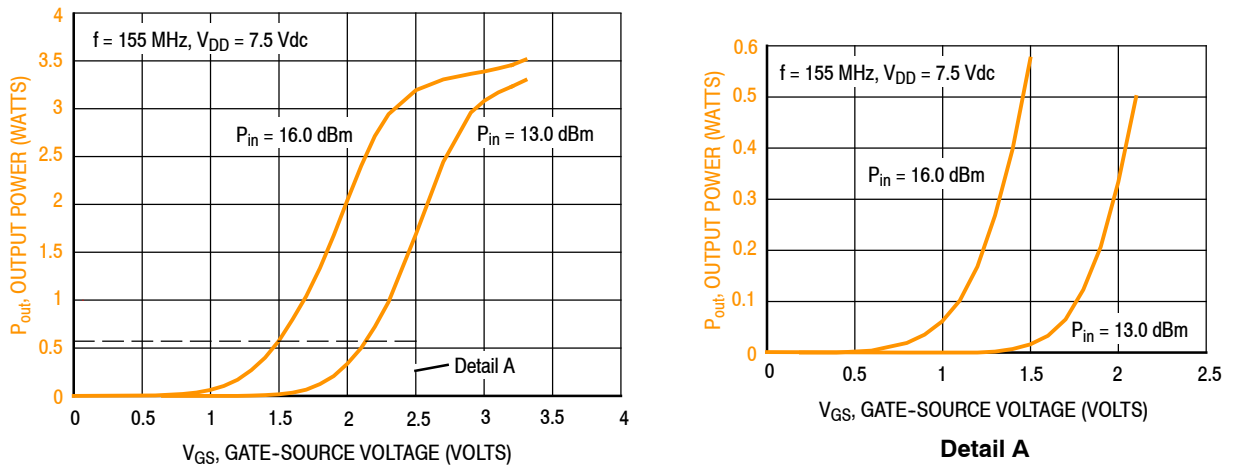

Figure 6. Output Power versus Gate-Source Voltage

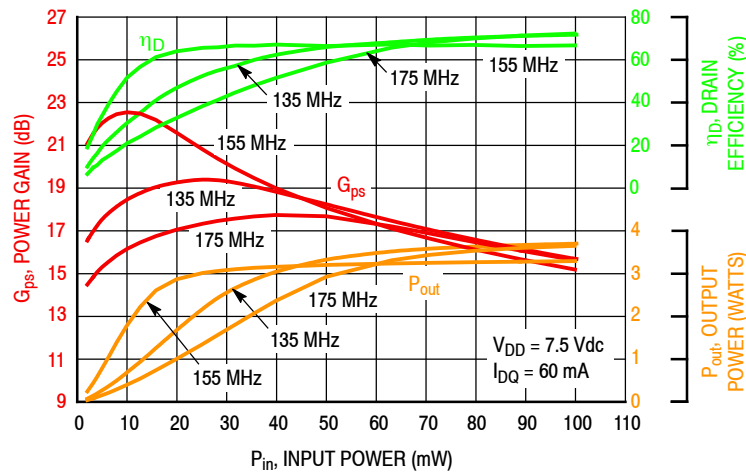
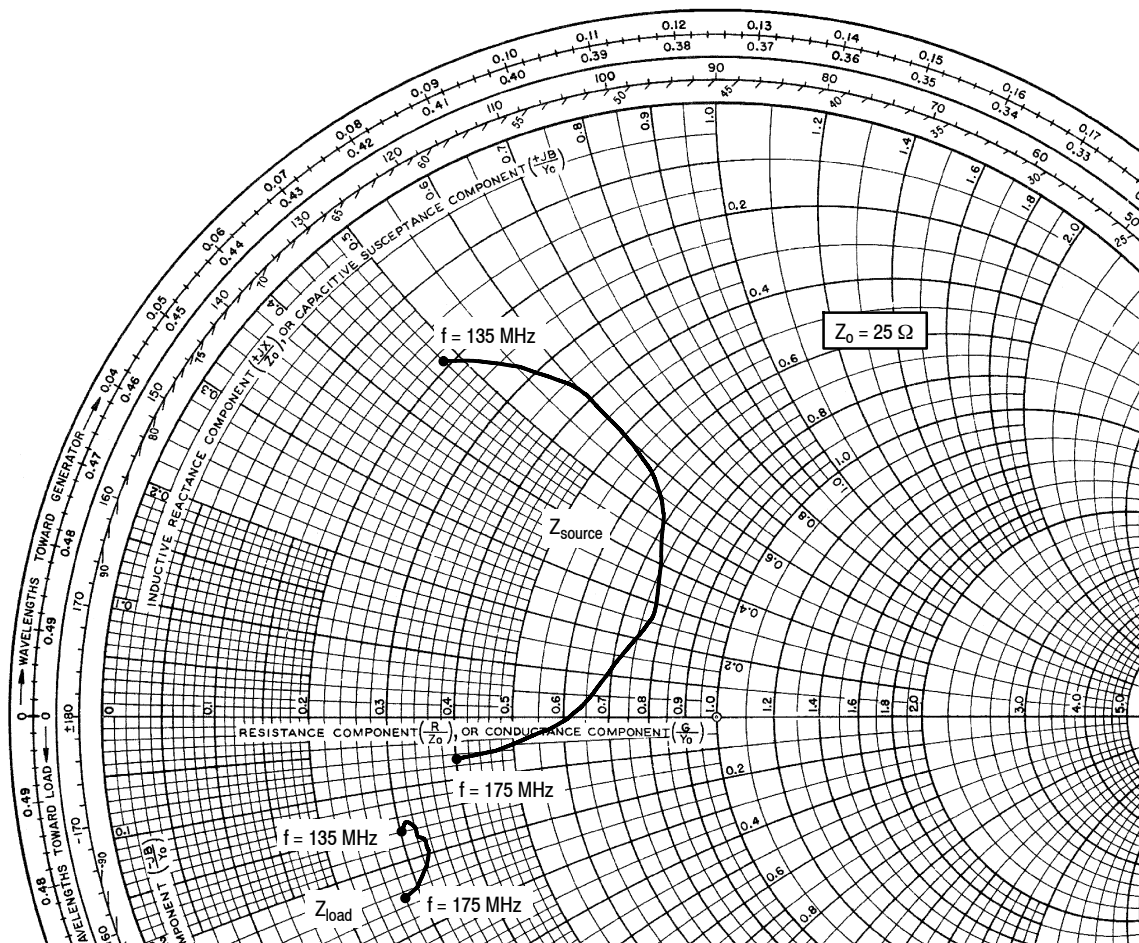

Figure 7. Power Gain, Drain Efficiency and Output Power versus Input Power and Frequency

136–174 MHz VHF BROADBAND REFERENCE CIRCUIT



f MHz	Z _{source} Ω	Z _{load} Ω
135	4.81 + j11.90	7.48 – j3.90
140	5.82 + j13.00	7.70 – j3.87
145	7.20 + j14.00	7.90 – j3.96
150	9.40 + j14.99	8.12 – j4.18
155	12.60 + j15.10	8.21 – j4.53
160	16.80 + j13.17	8.17 – j4.98
165	19.37 + j7.27	7.95 – j5.45
170	16.05 + j0.81	7.56 – j5.90
175	10.05 – j0.70	7.03 – j6.25

Z_{source} = Test circuit impedance as measured from gate to ground.

Z_{load} = Test circuit impedance as measured from drain to ground.

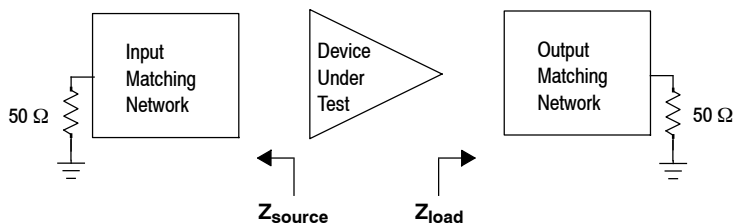

Figure 8. VHF Broadband Series Equivalent Source and Load Impedance — 136–174 MHz

350–520 MHz UHF BROADBAND REFERENCE CIRCUIT

Table 10. 350–520 MHz UHF Broadband Performance (In Freescale UHF Broadband Reference Circuit, 50 ohm system) $V_{DD} = 7.5$ Volts, $I_{DQ} = 50$ mA, $T_A = 25^\circ\text{C}$, CW

Frequency (MHz)	P_{in} (dBm)	G_{ps} (dB)	η_D (%)	P_{out} (W)
350	20.0	15.5	59.0	3.8
435	20.0	15.1	73.0	3.2
520	20.0	15.2	69.6	3.3

Table 11. Load Mismatch/Ruggedness (In Freescale UHF Broadband Reference Circuit)

Frequency (MHz)	Signal Type	VSWR	P_{in} (dBm)	Test Voltage, V_{DD}	Result
435	CW	> 65:1 at all Phase Angles	23.0	9.0	No Device Degradation

350–520 MHz UHF BROADBAND REFERENCE CIRCUIT — 0.83" × 1.86" (2.1 cm × 4.7 cm)

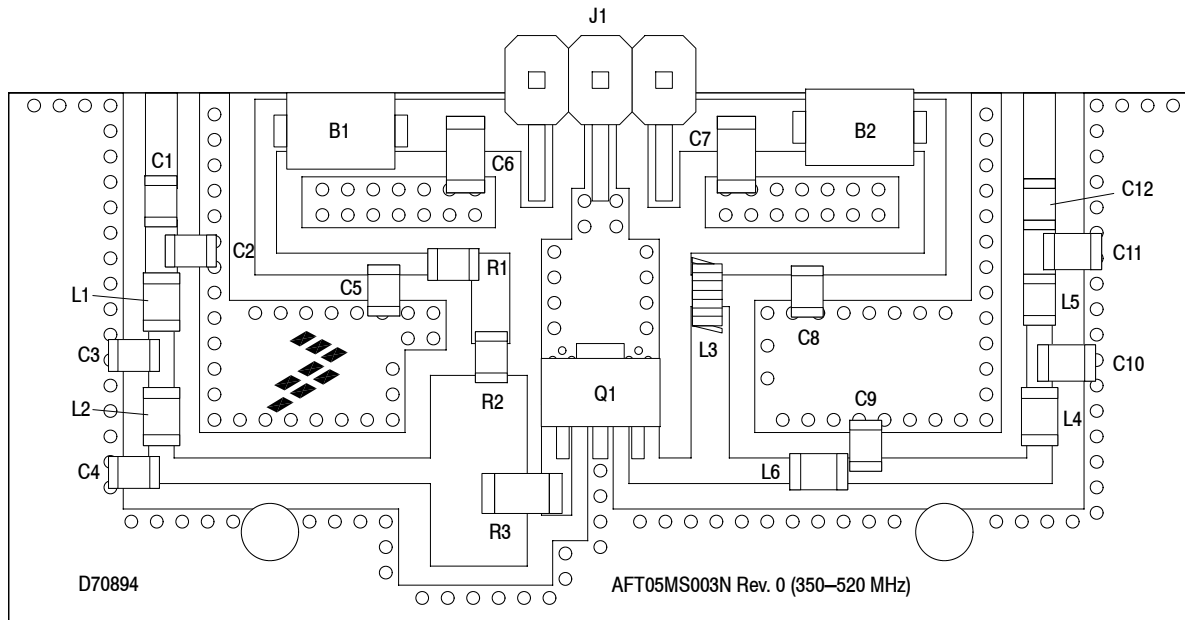

Figure 9. AFT05MS003N UHF Broadband Reference Circuit Component Layout — 350–520 MHz

Table 12. AFT05MS003N UHF Broadband Reference Circuit Component Designations and Values — 350–520 MHz

Part	Description	Part Number	Manufacturer
B1, B2	RF Beads	2743019447	Fair-Rite
C1, C8, C12	100 pF Chip Capacitors	ATC100A101JT150XT	ATC
C2	9.0 pF Chip Capacitor	GQM2195C2E9R0BB12D	Murata
C3	10 pF Chip Capacitor	GQM2195C2E100FB12D	Murata
C4, C9	39 pF Chip Capacitors	GQM2195C2E390GB12D	Murata
C5	100 pF Chip Capacitor	GQM2195C2E101GB12D	Murata
C6	1.0 μ F Chip Capacitor	GRM31CR72A105KA01L	Murata
C7	10 μ F Chip Capacitor	GRM31CR61H106KA12L	Murata
C10	15 pF Chip Capacitor	GQM2195C2E150FB12D	Murata
C11	3.9 pF Chip Capacitor	GQM2195C2E3R9BB12D	Murata
J1	Right-Angle Breakaway Headers (3 pins)	22-28-8360	Molex
L1	2.2 nH Inductor	L06032E2CGS	AVX
L2, L5	6.8 nH Inductors	ATC0805WL6R8	ATC
L3	19 nH Inductor	0806SQ19N	Coilcraft
L4	5.6 nH Inductor	L08055R6CEW	AVX
L6	1.8 nH Inductor	L08051E8CGS	AVX
Q1	RF Power LDMOS Transistor	AFT05MS003NT1	Freescale
R1, R2	22 Ω , 1/10 W Chip Resistor	RR1220Q-220-D	Susumu
R3	1.5 Ω , 1/10 W Chip Resistor	RC1206FR-071R5L	Yageo
PCB	0.020", $\epsilon_r = 4.8$, FR4 (S-1000)	D70894	MTL

TYPICAL CHARACTERISTICS — 350–520 MHz UHF BROADBAND REFERENCE CIRCUIT

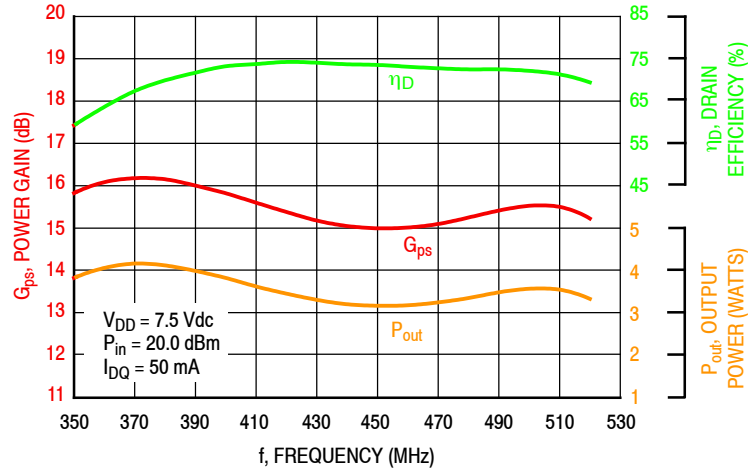

Figure 10. Power Gain, Drain Efficiency and Output Power versus Frequency at a Constant P_{in}

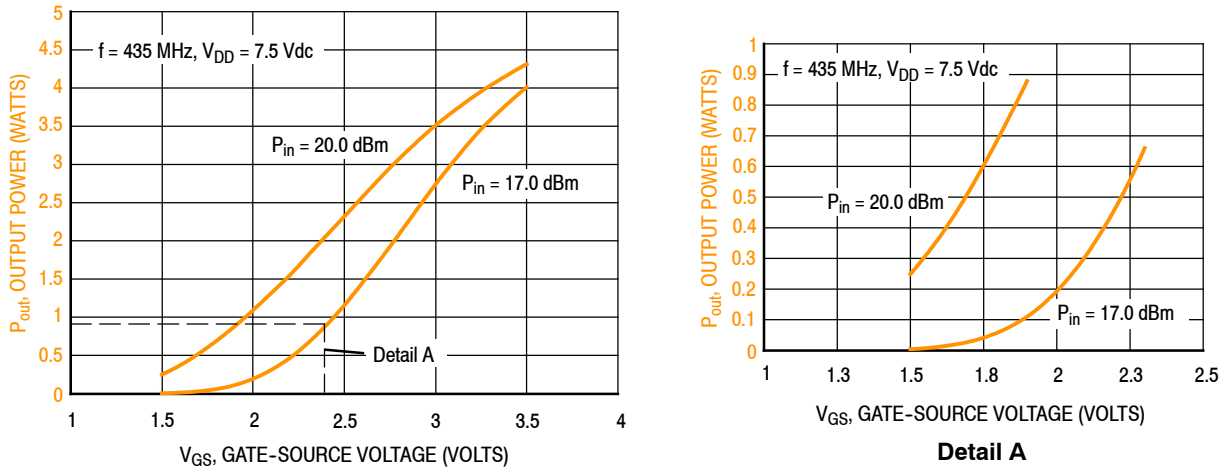

Figure 11. Output Power versus Gate-Source Voltage

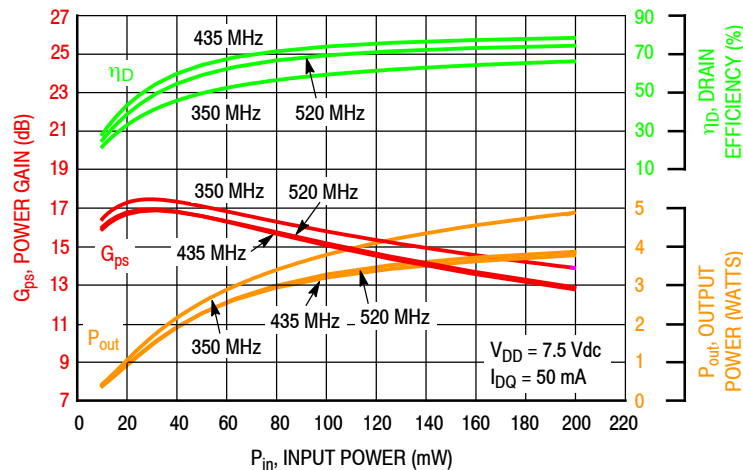
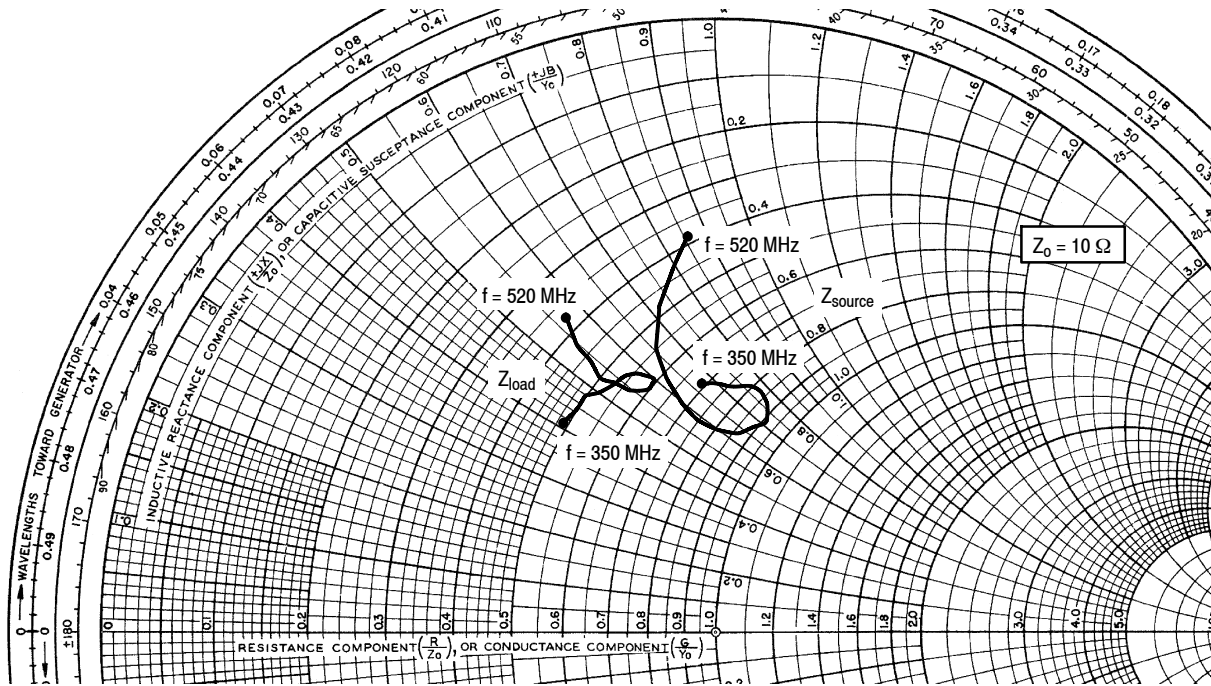

Figure 12. Power Gain, Drain Efficiency and Output Power versus Input Power and Frequency

350–520 MHz UHF BROADBAND REFERENCE CIRCUIT



f MHz	Z _{source} Ω	Z _{load} Ω
350	6.90 + j6.70	4.89 + j4.10
360	7.22 + j6.96	4.95 + j4.48
370	7.60 + j7.15	5.04 + j4.83
380	7.94 + j7.62	5.15 + j5.14
390	8.34 + j7.66	5.28 + j5.42
400	8.65 + j7.61	5.44 + j5.65
410	8.97 + j7.37	5.58 + j5.82
420	9.08 + j7.06	5.73 + j5.90
430	8.91 + j6.73	5.86 + j5.95
440	8.63 + j6.34	5.94 + j5.90
450	8.14 + j6.04	5.95 + j5.81
460	7.49 + j5.89	5.87 + j5.66
470	6.77 + j5.95	5.68 + j5.51
480	6.05 + j6.21	5.39 + j5.39
490	5.38 + j6.64	5.03 + j5.33
500	4.80 + j7.20	4.60 + j5.35
510	4.30 + j7.86	4.16 + j5.47
520	3.94 + j8.57	3.68 + j5.71

Z_{source} = Test circuit impedance as measured from gate to ground.

Z_{load} = Test circuit impedance as measured from drain to ground.

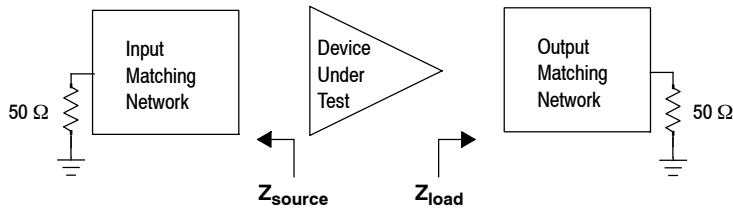

Figure 13. UHF Broadband Series Equivalent Source and Load Impedance — 350–520 MHz

520 MHz NARROWBAND PRODUCTION TEST FIXTURE — 3" x 5" (7.62 cm x 12.7 cm)

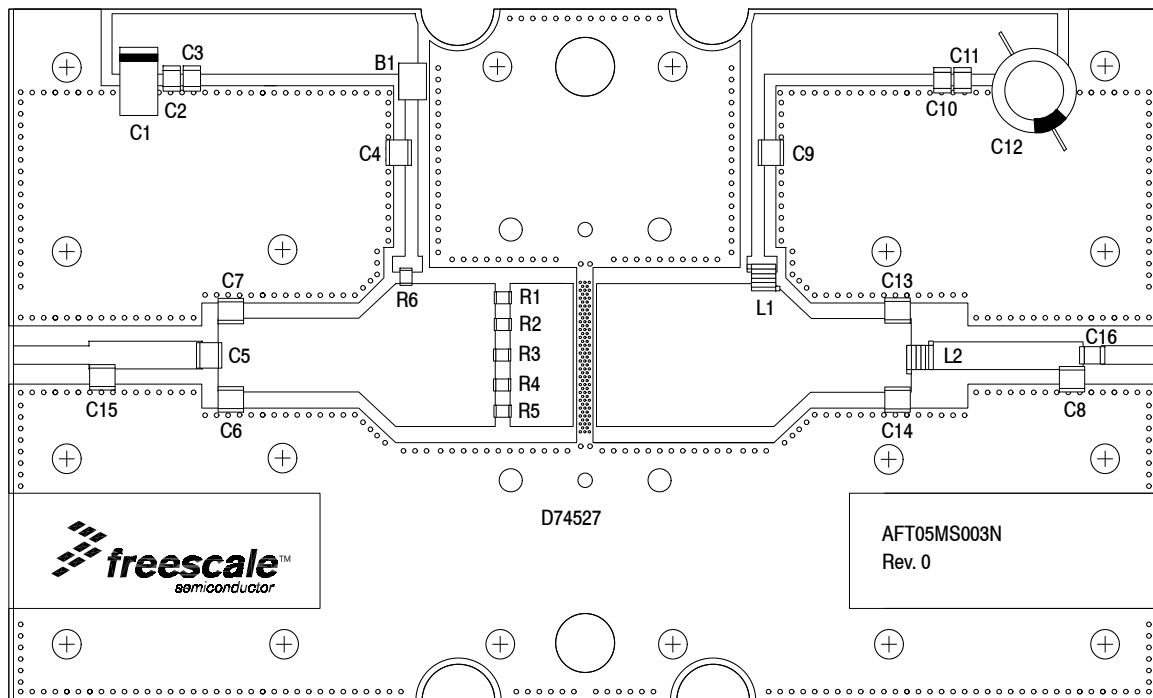

Figure 14. AFT05MS003N Narrowband Production Test Circuit Component Layout — 520 MHz

Table 13. AFT05MS003N Narrowband Production Test Circuit Component Designations and Values — 520 MHz

Part	Description	Part Number	Manufacturer
B1	Short RF Bead	2743019447	Fair-Rite
C1	22 μ F, 35 V Tantalum Capacitor	T491X226K035AT	Kemet
C2, C11	0.1 μ F Chip Capacitors	CDR33BX104AKWS	Kemet
C3, C10	0.01 μ F Chip Capacitors	C0805C103K5RAC	Kemet
C4, C9	180 pF Chip Capacitors	ATC100B181JT300XT	ATC
C5	68 pF Chip Capacitor	ATC100B680JT500XT	ATC
C6, C7	18 pF Chip Capacitors	ATC100B180JT500XT	ATC
C8	4.7 pF Chip Capacitor	ATC100B4R7JT500XT	ATC
C12	330 μ F, 35 V Electrolytic Capacitor	MCGPR35V337M10X16-RH	Multicomp
C13	13 pF Chip Capacitor	ATC100B130JT500XT	ATC
C14	16 pF Chip Capacitor	ATC100B160JT500XT	ATC
C15	3.3 pF Chip Capacitor	ATC100B3R3JT500XT	ATC
C16	6.8 pF Chip Capacitor	ATC100B6R8CT500XT	ATC
L1	8 nH, 3 Turn Inductor	A03TKLC	Coilcraft
L2	5 nH, 2 Turn Inductor	A02TKLC	Coilcraft
R1, R2, R3, R4, R5, R6	3.9 Ω , 1/4 W Chip Resistors	RC1206FR-073R9L	Yageo
PCB	Rogers RO4350, 0.030", $\epsilon_r = 3.66$	D74527	MTL

TYPICAL CHARACTERISTICS — 520 MHz NARROWBAND PRODUCTION TEST FIXTURE

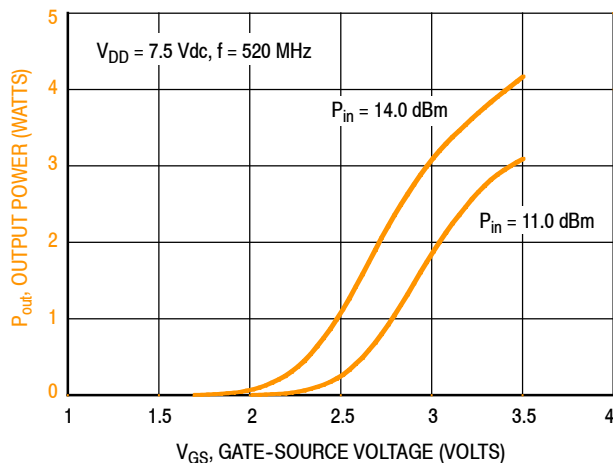

Figure 15. Output Power versus Gate-Source Voltage

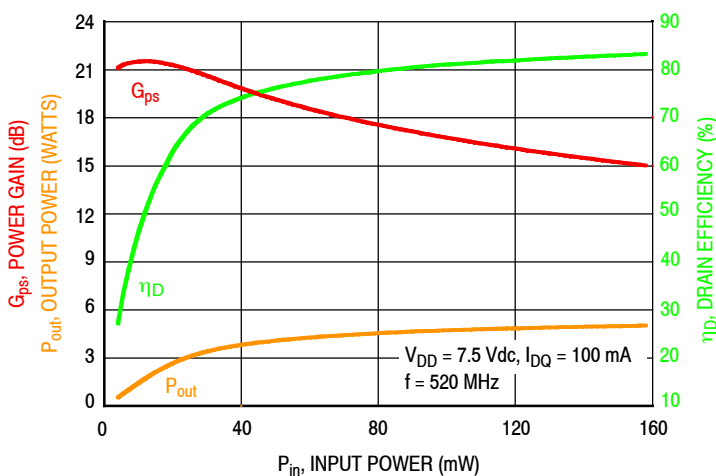

Figure 16. Power Gain, Output Power and Drain Efficiency versus Input Power

f MHz	Z_{source} Ω	Z_{load} Ω
520	$1.86 + j4.46$	$4.30 + j3.43$

Z_{source} = Test circuit impedance as measured from gate to ground.

Z_{load} = Test circuit impedance as measured from drain to ground.

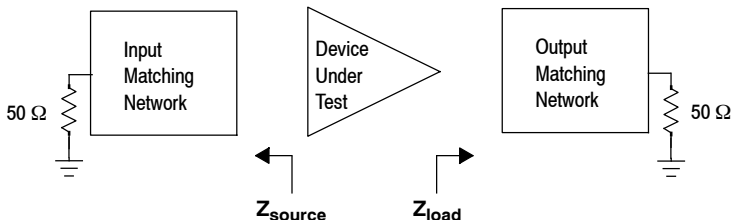

Figure 17. Narrowband Series Equivalent Source and Load Impedance — 520 MHz

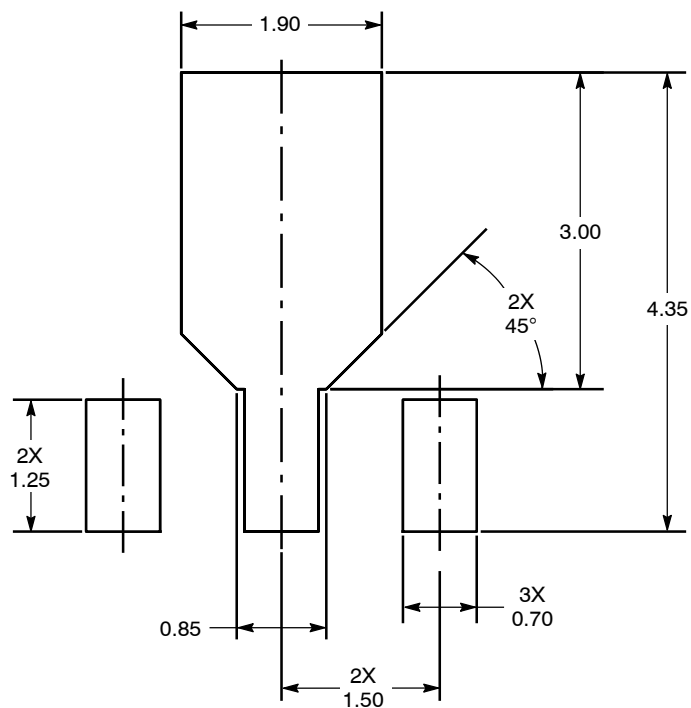

Figure 18. PCB Pad Layout for SOT-89A

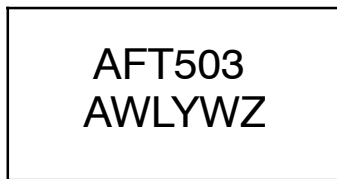
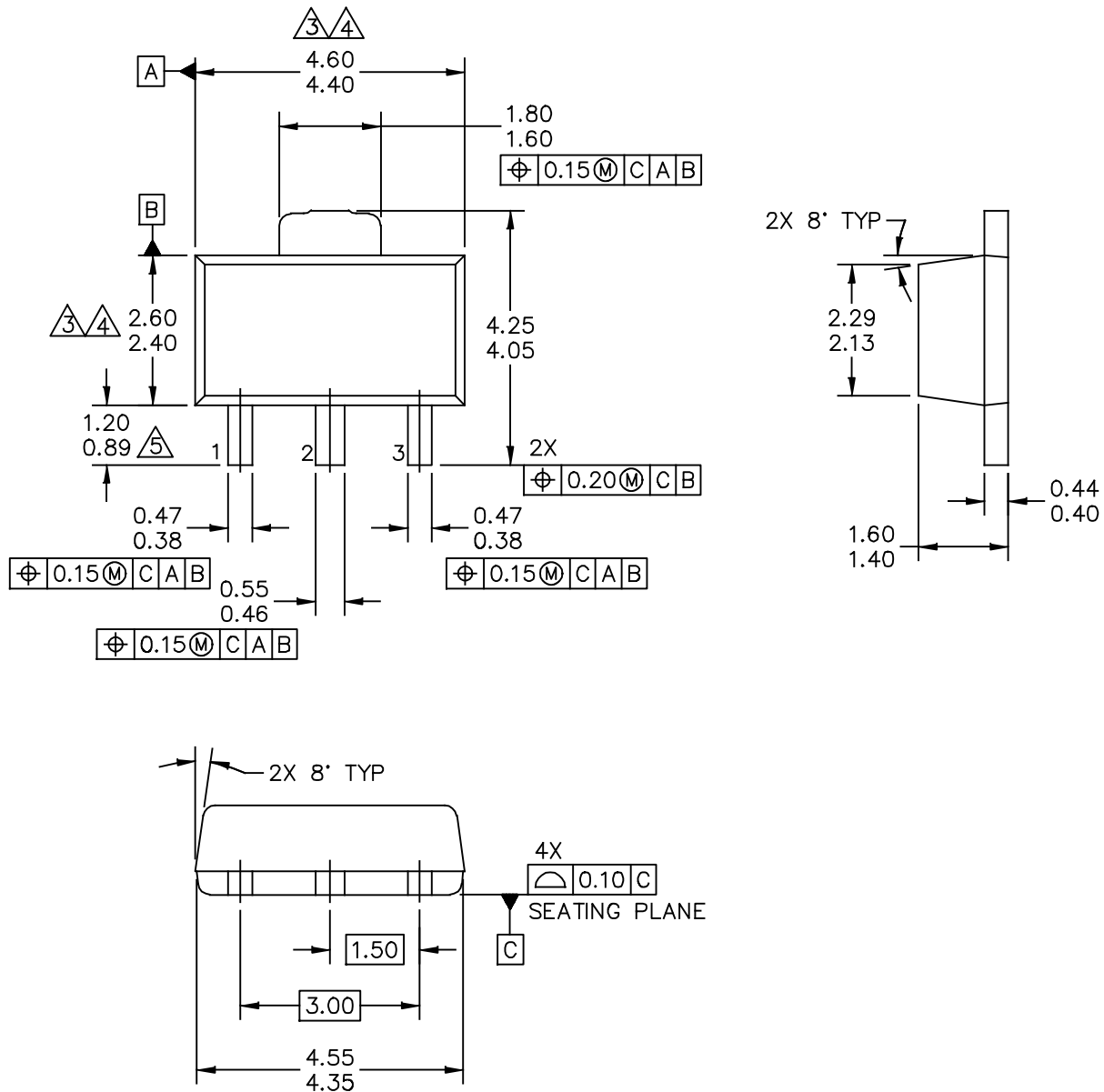

Figure 19. Product Marking

PACKAGE DIMENSIONS



© FREESCALE SEMICONDUCTOR, INC. ALL RIGHTS RESERVED.	MECHANICAL OUTLINE	PRINT VERSION NOT TO SCALE	
TITLE: SOT-89A, 3 LEAD, 4.5 X 2.5 PKG, 1.5 MM PITCH	DOCUMENT NO: 98ASA00241D	REV: 0	
	CASE NUMBER: 2142-01	15 JUL 2010	
	STANDARD: NON-JEDEC		

- Pin 1. Drain
- 2. Gate
- 3. Source

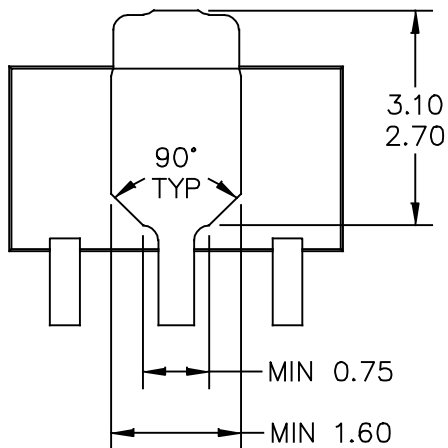

BOTTOM VIEW

© FREESCALE SEMICONDUCTOR, INC. ALL RIGHTS RESERVED.	MECHANICAL OUTLINE	PRINT VERSION NOT TO SCALE	
TITLE: SOT-89A, 3 LEAD, 4.5 X 2.5 PKG, 1.5 MM PITCH	DOCUMENT NO: 98ASA00241D	REV: 0	
	CASE NUMBER: 2142-01	15 JUL 2010	
	STANDARD: NON-JEDEC		

NOTES:

1. DIMENSIONING AND TOLERANCING PER ASME Y14.5M – 1994.

2. ALL DIMENSIONS ARE IN MILLIMETERS.

3. DIMENSIONS DOES NOT INCLUDE MOLD FLASH. PROTRUSIONS OR GATE BURRS. MOLD FLASH, PROTRUSIONS OR GATE BURRS SHALL NOT EXCEED 0.5 MM PER END. DIMENSION DOES NOT INCLUDE INTERLEAD FLASH OR PROTRUSION. INTERLEAD FLASH OR PROTRUSION SHALL NOT EXCEED 0.5 MM PER SIDE.

4. DIMENSION ARE DETERMINED AT THE OUTMOST EXTREMES OF THE PLASTIC BODY EXCLUSIVE OF MOLD FLASH, TIE BAR BURRS, GATE BURRS AND INTERLEAD FLASH, BUT INCLUDING ANY MISMATCH BETWEEN THE TOP AND BOTTOM OF THE PLASTIC BODY.

5. TERMINAL NUMBERS ARE SHOWN FOR REFERENCE ONLY.

© FREESCALE SEMICONDUCTOR, INC. ALL RIGHTS RESERVED.	MECHANICAL OUTLINE	PRINT VERSION NOT TO SCALE	
TITLE: SOT-89A, 3 LEAD, 4.5 X 2.5 PKG, 1.5 MM PITCH	DOCUMENT NO: 98ASA00241D	REV: 0	
	CASE NUMBER: 2142-01	15 JUL 2010	
	STANDARD: NON-JEDEC		

Refer to the following resources to aid your design process.

Application Notes

- AN1955: Thermal Measurement Methodology of RF Power Amplifiers

Engineering Bulletins

- EB212: Using Data Sheet Impedances for RF LDMOS Devices

Software

- Electromigration MTTF Calculator
- RF High Power Model
- .s2p File

Development Tools

- Printed Circuit Boards

To Download Resources Specific to a Given Part Number:

1. Go to <http://www.freescale.com/rf>
2. Search by part number
3. Click part number link
4. Choose the desired resource from the drop down menu

REVISION HISTORY

The following table summarizes revisions to this document.

Revision	Date	Description
0	Aug. 2015	• Initial Release of Data Sheet

How to Reach Us:

Home Page:
freescale.com

Web Support:
freescale.com/support

Information in this document is provided solely to enable system and software implementers to use Freescale products. There are no express or implied copyright licenses granted hereunder to design or fabricate any integrated circuits based on the information in this document.

Freescale reserves the right to make changes without further notice to any products herein. Freescale makes no warranty, representation, or guarantee regarding the suitability of its products for any particular purpose, nor does Freescale assume any liability arising out of the application or use of any product or circuit, and specifically disclaims any and all liability, including without limitation consequential or incidental damages. "Typical" parameters that may be provided in Freescale data sheets and/or specifications can and do vary in different applications, and actual performance may vary over time. All operating parameters, including "typicals," must be validated for each customer application by customer's technical experts. Freescale does not convey any license under its patent rights nor the rights of others. Freescale sells products pursuant to standard terms and conditions of sale, which can be found at the following address: freescale.com/SalesTermsandConditions.

Freescale and the Freescale logo are trademarks of Freescale Semiconductor, Inc., Reg. U.S. Pat. & Tm. Off. Airfast is a trademark of Freescale Semiconductor, Inc. All other product or service names are the property of their respective owners.

© 2015 Freescale Semiconductor, Inc.