

GC2X10MPS12-247

1200 V SiC MPS™ Diode

Silicon Carbide Power Schottky Diode



V_{RRM}	=	1200 V
$I_F (T_C = 135^\circ\text{C})$	=	44 A*
Q_C	=	112 nC*

Features

- High Avalanche (UIS) Capability
- Enhanced Surge Current Capability
- 175 °C Maximum Operating Temperature
- Temperature Independent Switching Behavior
- Positive Temperature Coefficient Of V_F
- Extremely Fast Switching Speeds
- Superior Figure of Merit Q_C/I_F

Advantages

- Low Standby Power Losses
- Improved Circuit Efficiency (Lower Overall Cost)
- Low Switching Losses
- Ease of Paralleling Devices without Thermal Runaway
- Smaller Heat Sink Requirements
- Low Reverse Recovery Current
- Low Device Capacitance
- Low Reverse Leakage Current at Operating Temperature

Package

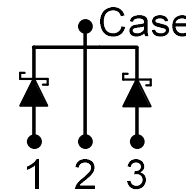
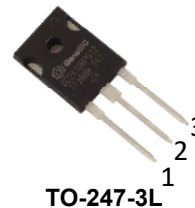

Applications

- Power Factor Correction (PFC)
- Switched-Mode Power Supply (SMPS)
- Solar Inverters
- Wind Turbine Inverters
- Motor Drives
- Induction Heating
- Uninterruptible Power Supply (UPS)
- High Voltage Multipliers

Absolute Maximum Ratings

Parameter	Symbol	Conditions	Values	Unit
Repetitive Peak Reverse Voltage (Per Leg)	V_{RRM}		1200	V
Continuous Forward Current (Per Leg/Per Device)	I_F	$T_C = 25^\circ\text{C}, D = 1$	45/90	A
		$T_C = 135^\circ\text{C}, D = 1$	22/44	
		$T_C = 165^\circ\text{C}, D = 1$	10/20	
Non-Repetitive Peak Forward Surge Current, Half Sine Wave (Per Leg)	$I_{F,SM}$	$T_C = 25^\circ\text{C}, t_p = 10\text{ ms}$	81	A
		$T_C = 150^\circ\text{C}, t_p = 10\text{ ms}$	65	
Repetitive Peak Forward Surge Current, Half Sine Wave (Per Leg)	$I_{F,RM}$	$T_C = 25^\circ\text{C}, t_p = 10\text{ ms}$	50	A
		$T_C = 150^\circ\text{C}, t_p = 10\text{ ms}$	35	
Non-Repetitive Peak Forward Surge Current (Per Leg)	$I_{F,max}$	$T_C = 25^\circ\text{C}, t_p = 10\text{ }\mu\text{s}$	860	A
i^2t Value (Per Leg)	$\int i^2 dt$	$T_C = 25^\circ\text{C}, t_p = 10\text{ ms}$	30	A^2s
Non-Repetitive Avalanche Energy (Per Leg)	E_{AS}	$L = 5\text{ mH}, I_{AV} = 10\text{ A}, V_{DD} = 60\text{ V}$	150	mJ
Diode Ruggedness (Per Leg)	dV/dt	$V_R = 0 \sim 960\text{ V}$	100	V/ μs
Power Dissipation (Per Leg/Per Device)	P_{tot}	$T_C = 25^\circ\text{C}$	340/680	W
Operating and Storage Temperature	T_j, T_{stg}		-55 to 175	$^\circ\text{C}$

Electrical Characteristics (Per Leg)

Parameter	Symbol	Conditions	Values			Unit
			min.	typ.	max.	
Diode Forward Voltage	V_F	$I_F = 10\text{ A}, T_j = 25^\circ\text{C}$	1.5	1.8	V	
		$I_F = 10\text{ A}, T_j = 175^\circ\text{C}$	2.3	2.7		
Reverse Current	I_R	$V_R = 1200\text{ V}, T_j = 25^\circ\text{C}$	1	14	μA	
		$V_R = 1200\text{ V}, T_j = 175^\circ\text{C}$	8	95		
Total Capacitive Charge	Q_C	$I_F \leq I_{F,MAX}$ $dI_F/dt = 200\text{ A}/\mu\text{s}$ $T_j = 175^\circ\text{C}$	$V_R = 400\text{ V}$	37	nC	
			$V_R = 800\text{ V}$	56		
Switching Time	t_s	$V_R = 400\text{ V}$ $V_R = 800\text{ V}$	< 10	ns		
Total Capacitance	C	$V_R = 1\text{ V}, f = 1\text{ MHz}, T_j = 25^\circ\text{C}$	616	pF		
		$V_R = 800\text{ V}, f = 1\text{ MHz}, T_j = 25^\circ\text{C}$	41			

Thermal / Mechanical Characteristics

Thermal Resistance, Junction – Case (Per Leg)	R_{thJC}	0.44	$^\circ\text{C}/\text{W}$
---	------------	------	---------------------------

* Per Device, ** Per Leg

GC2X10MPS12-247

1200 V SiC MPS™ Diode

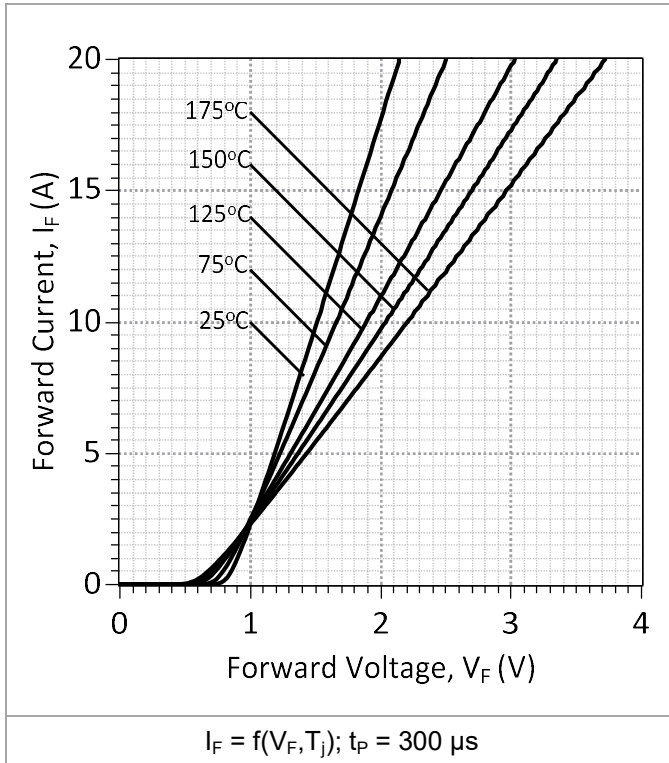

Figure 1: Typical Forward Characteristics (Per Leg)

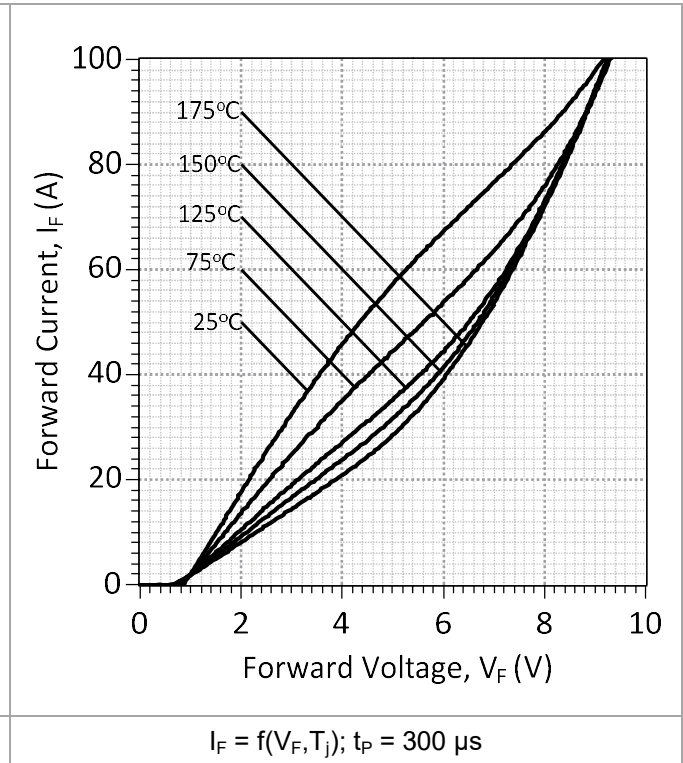

Figure 2: Typical High Current Forward Characteristics (Per Leg)

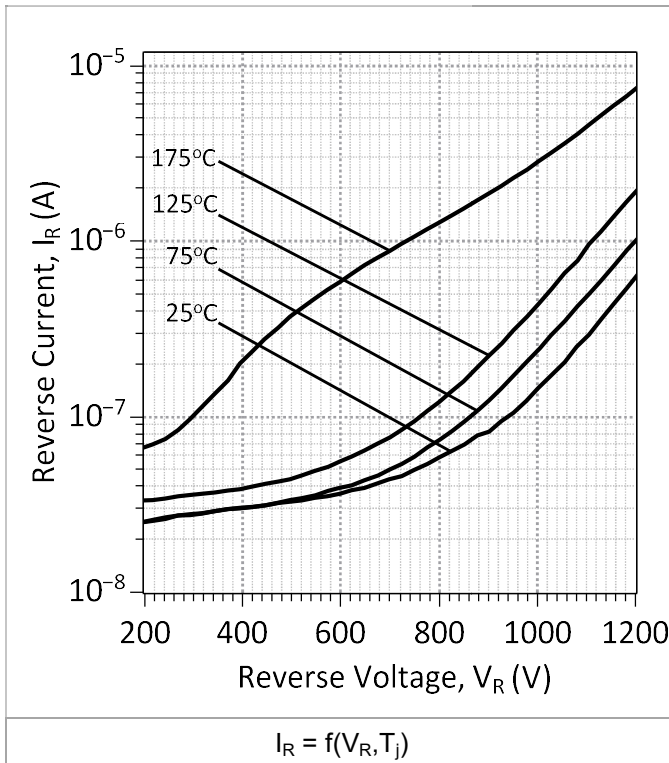

Figure 3: Typical Reverse Characteristics (Per Leg)

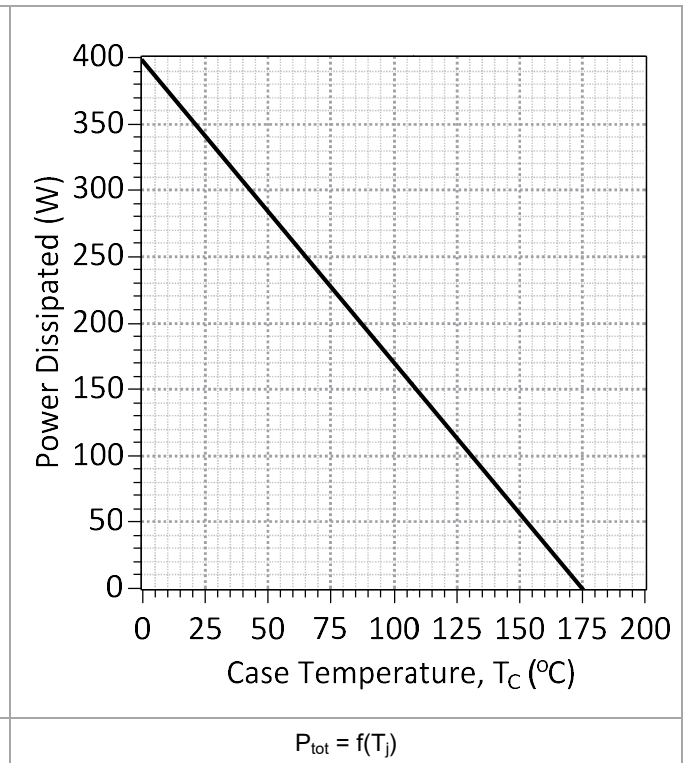

Figure 4: Power Derating Curve (Per Leg)

GC2X10MPS12-247

1200 V SiC MPS™ Diode

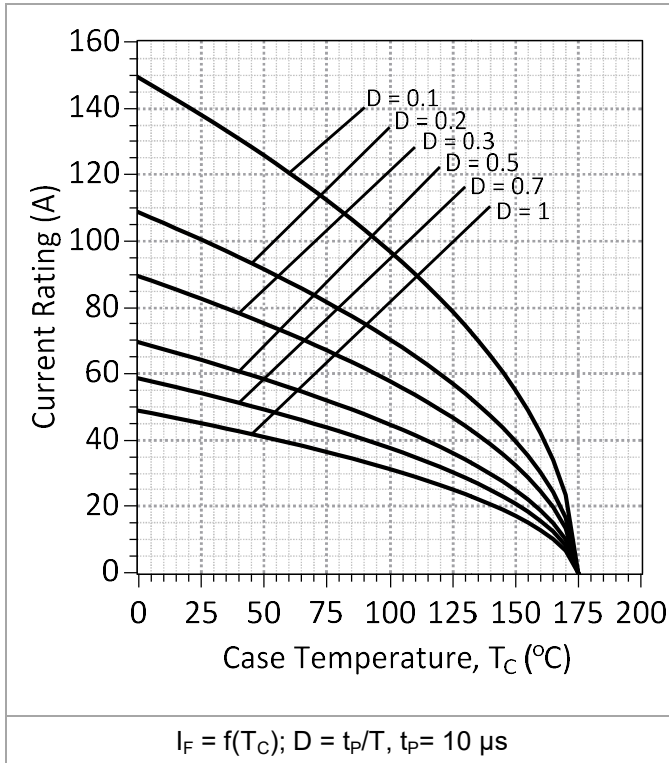

Figure 5: Current Derating Curves (Per Leg)

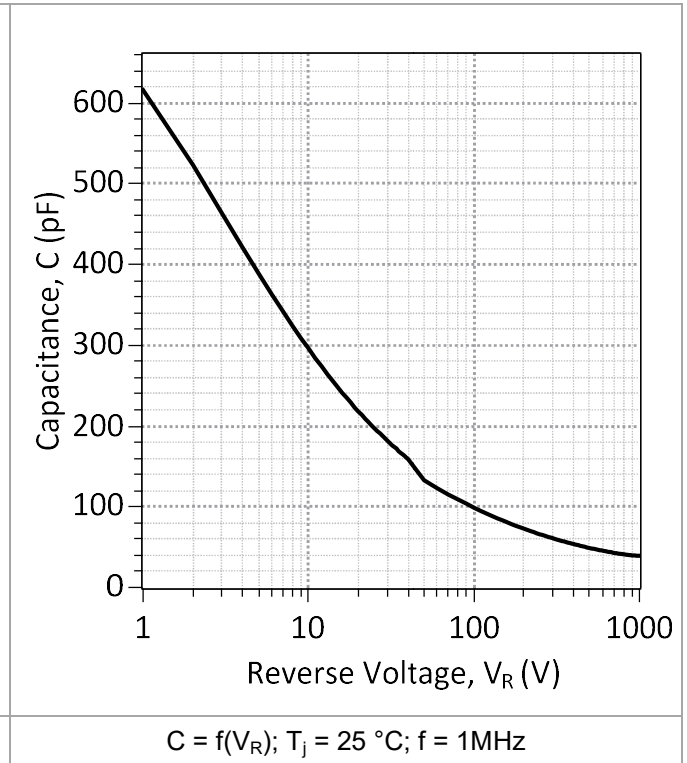

Figure 6: Typical Junction Capacitance vs Reverse Voltage Characteristics (Per Leg)

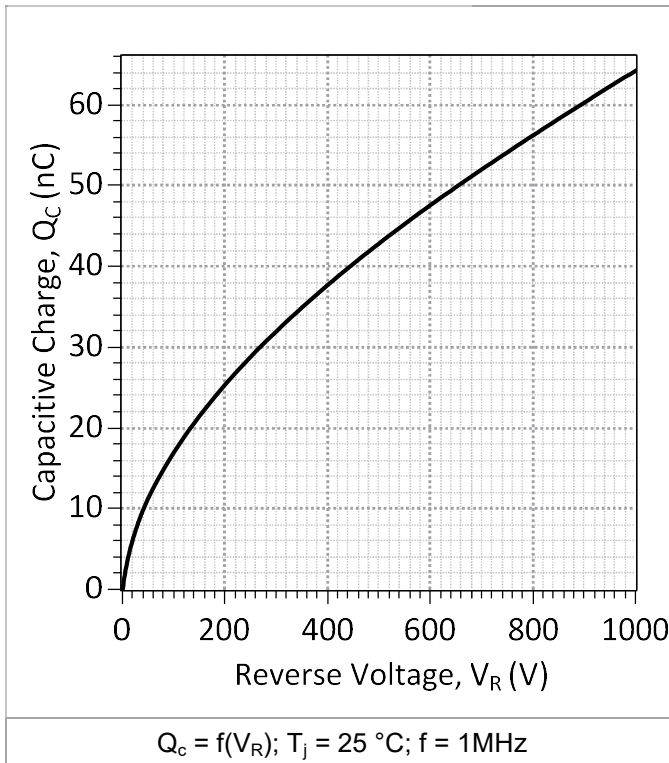

Figure 7: Typical Capacitive Charge vs. Reverse Voltage Characteristics (Per Leg)

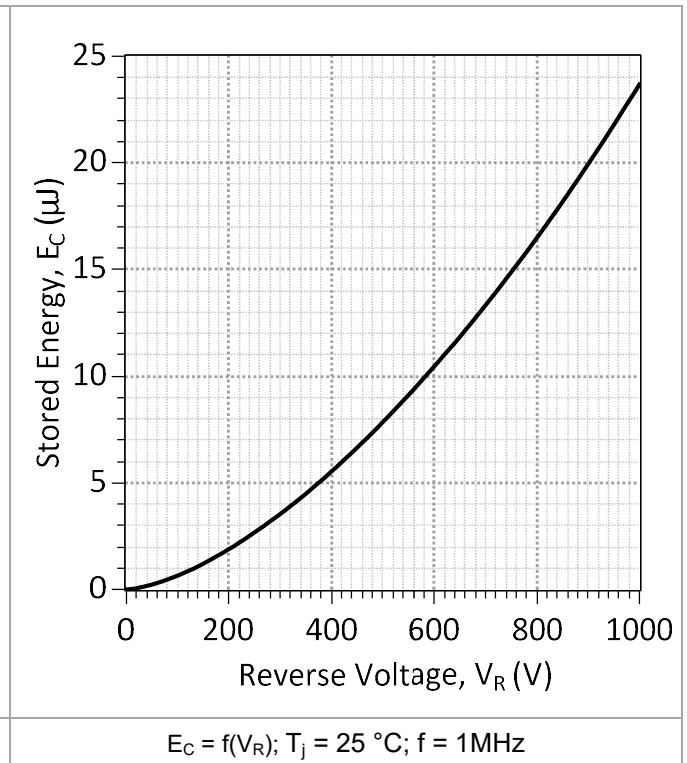

Figure 8: Typical Capacitive Energy vs. Reverse Voltage Characteristics (Per Leg)

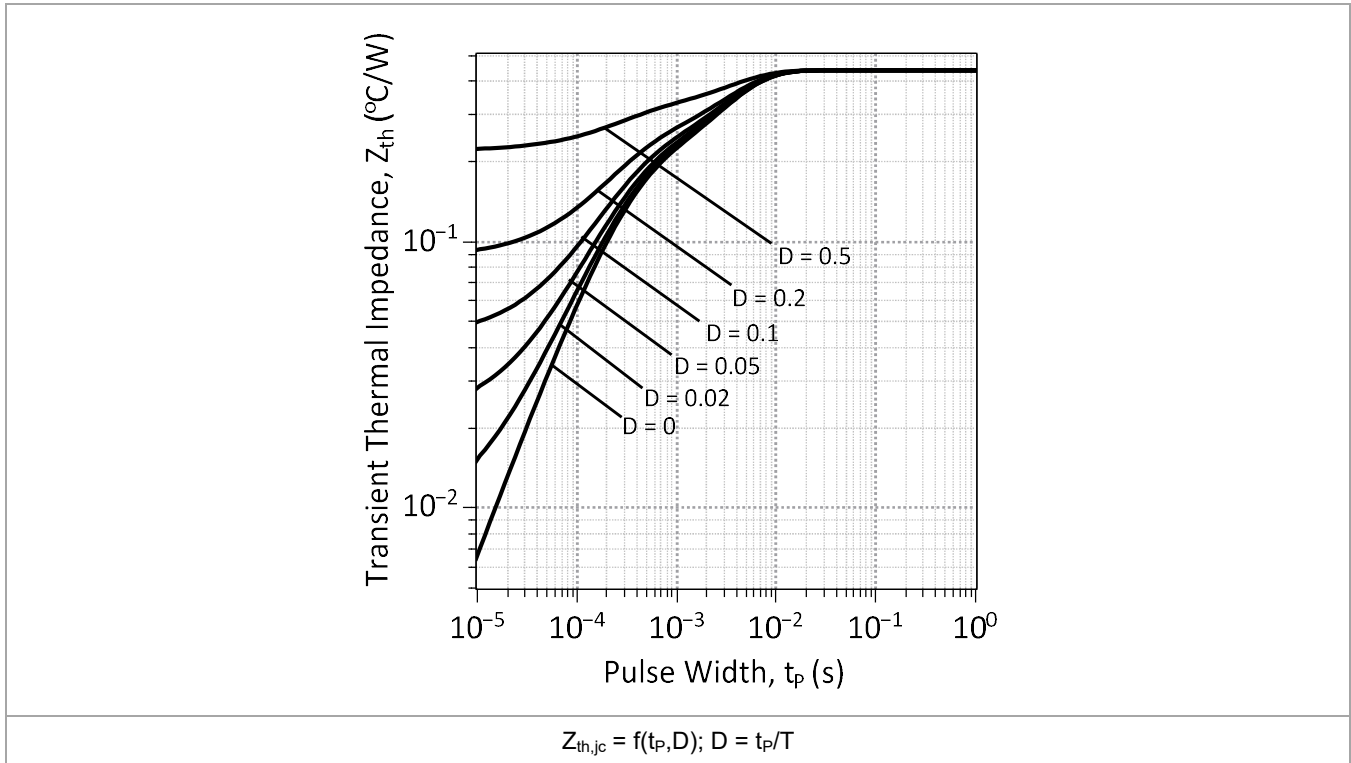

Figure 9: Transient Thermal Impedance (Per Leg)

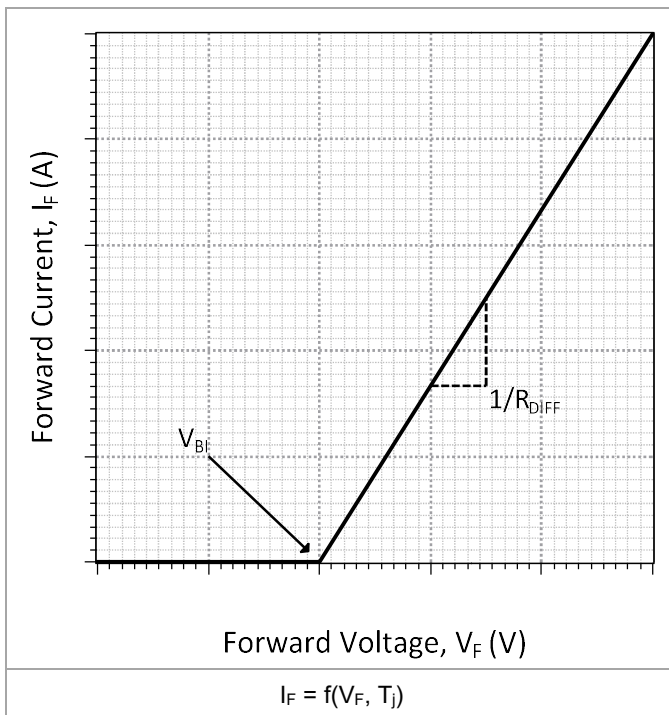

Figure 10: Forward Curve Model (Per Leg)

$$I_F = (V_F - V_{BI})/R_{DIFF}$$

Built-In Voltage (V_{BI}):

$$V_{BI}(T_j) = m \cdot T_j + b,$$

$$m = -1.32e-03, b = 0.915$$

Differential Resistance (R_{DIFF}):

$$R_{DIFF}(T_j) = a \cdot T_j^2 + b \cdot T_j + c (\Omega);$$

$$a = 7.30e-05, b = 8.99e-03, c = 2.26$$

GC2X10MPS12-247

1200 V SiC MPS™ Diode

Package Dimensions:



TO-247-3L

PACKAGE OUTLINE

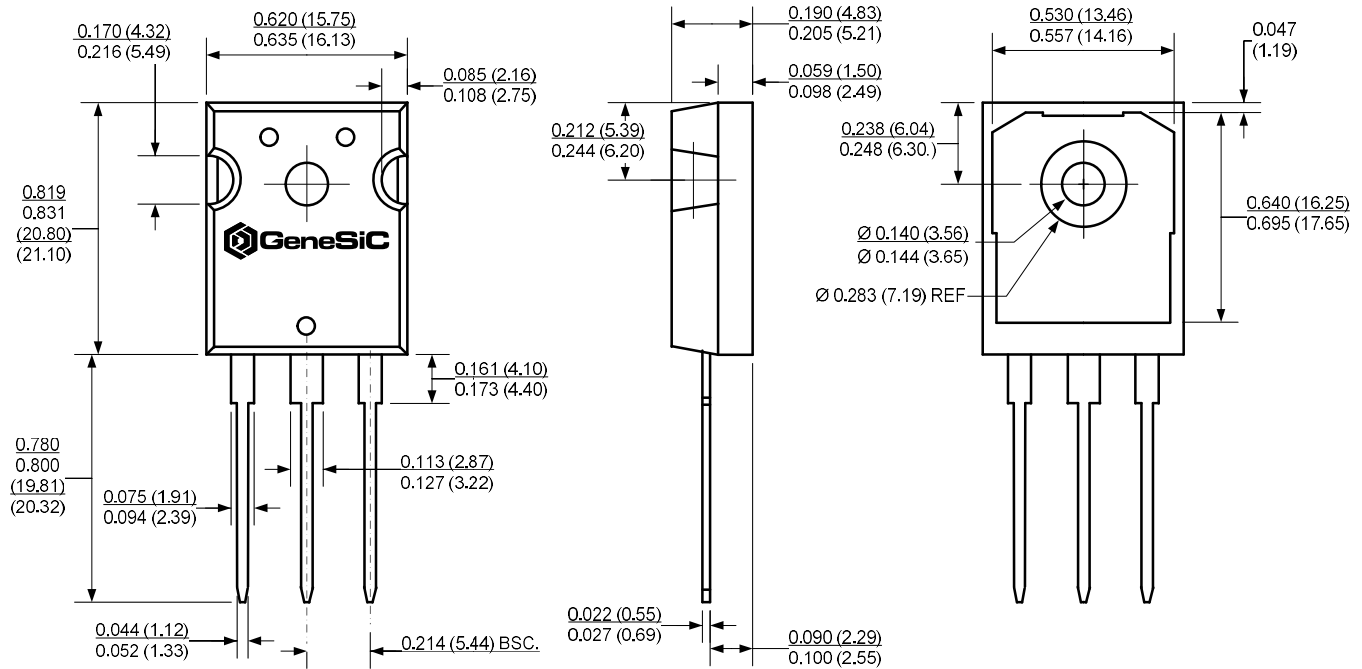

Recommended Solder Pad Layout

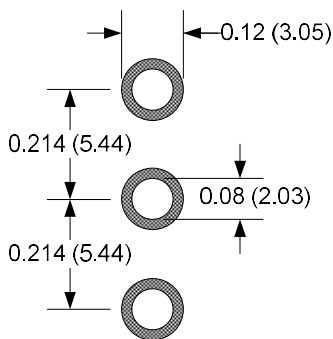

NOTE

1. CONTROLLED DIMENSION IS INCH. DIMENSION IN BRACKET IS MILLIMETER.
2. DIMENSIONS DO NOT INCLUDE END FLASH, MOLD FLASH, MATERIAL PROTRUSIONS

GC2X10MPS12-247

1200 V SiC MPS™ Diode



RoHS Compliance

The levels of RoHS restricted materials in this product are below the maximum concentration values (also referred to as the threshold limits) permitted for such substances, or are used in an exempted application, in accordance with EU Directive 2011/65/EC (RoHS2), as implemented January 2, 2013. RoHS Declarations for this product can be obtained from your GeneSiC representative.

REACH Compliance

REACH substances of high concern (SVHCs) information is available for this product. Since the European Chemical Agency (ECHA) has published notice of their intent to frequently revise the SVHC listing for the foreseeable future, please contact a GeneSiC representative to insure you get the most up-to-date REACH SVHC Declaration. REACH banned substance information (REACH Article 67) is also available upon request.

This product has not been designed or tested for use in, and is not intended for use in, applications implanted into the human body nor in applications in which failure of the product could lead to death, personal injury or property damage, including but not limited to equipment used in the operation of nuclear facilities, life-support machines, cardiac defibrillators or similar emergency medical equipment, aircraft navigation or communication or control systems, or air traffic control systems.

GeneSiC disclaims all and any warranty and liability arising out of use or application of any product. No license, express or implied to any intellectual property rights is granted by this document.

Related Links

- Soldering Document: <http://www.genesicsemi.com/quality/quality-manual/>
- Tin-whisker Report: <http://www.genesicsemi.com/quality/compliance/>
- Reliability Report: <http://www.genesicsemi.com/quality/reliability/>

GC2X10MPS12-247

1200 V SiC MPS™ Diode



SPICE Model Parameters

This is a secure document. Please copy this code from the SPICE model PDF file on our website (http://www.genesicsemi.com/sic_rectifiers_diodes/merged_pin_schottky/GC2X10MPS12-247_SPICE.pdf) into LTSPICE (version 4) software for simulation of the GC2X10MPS12-247. All the simulations are per Leg.

```
* GeneSiC Semiconductor SiC MPS™ Rectifier
* Revision: 1.1
* Date: February-2018
*****
** TO-247-3 package
*****
.SUBCKT GC2X10MPS12 A K Case
L_anode A AD 6.5n
D1 AD Case GC10MPS12
L_cathode K Case 6.5n
.ends
*****
.SUBCKT GC2X10MPS12 ANODE KATHODE
D1 ANODE KATHODE GC10MPS12_SCHOTTKY
.MODEL GC10MPS12_SCHOTTKY D
+ IS 8.721E-15 RS 0.062
+ N 1 IKF 500
+ EG 1.2 XTI 2
+ TRS1 0.005434 TRS2 2.717E-05
+ CJO 8.59E-10 VJ 0.879
+ M 0.438 FC 0.5
+ TT 1.00E-10 BV 1600
+ IBV 1E-06 VPK 1200
+ IAVE 10 TYPE SiC_MPS™
+ MFG GeneSiC_Semi
.ENDS
* End of GC2X10MPS12-247 SPICE Model
*****
* This model is provided "AS IS, WHERE IS, AND WITH NO WARRANTY OF ANY KIND
* EITHER EXPRESSED OR IMPLIED, INCLUDING BUT NOT LIMITED TO ANY IMPLIED
* WARRANTIES OF MERCHANTABILITY AND FITNESS FOR A PARTICULAR PURPOSE."
```