

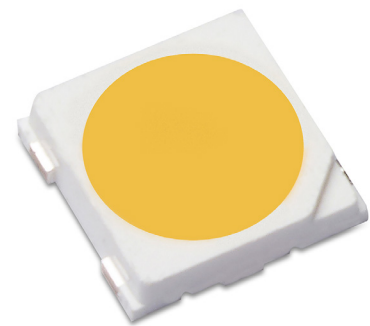

# LUXEON 3535L with CrispColor Technology™

Fashion retail lighting that makes an impact, highlighting rich colors and increasing contrast

LUXEON 3535L with CrispColor Technology is the ultimate solution that makes fabrics come to life. With efficient solid state lighting technology, the contrast of colors has never been so vivid. Our special phosphor technology has created a higher gamut color rendering than existing solutions with a specific color point below the Black Body Line to allow for Class A products. Combined with industry leading performance in a common 3535L platform, LUXEON 3535L with CrispColor Technology creates a highly impactful retail experience with all of the advantages of LUXEON 3535L, including leading performance, lower voltage, higher driving current, and excellent reliability.



## FEATURES AND BENEFITS

- Industry standard footprint for drop-in replacement designs
- Maximum drive current of up to 240mA allows for reduction of LED count
- 3- and 5-step MacAdam ellipse color kits available

## PRIMARY APPLICATIONS

- Downlights
- Indoor Area Lighting
  - TLEDs
  - Troffers
- Lamps

# Table of Contents

<b>General Product Information</b> .....	<b>2</b>
Product Test Conditions .....	2
Part Number Nomenclature .....	2
Lumen Maintenance .....	2
Environmental Compliance .....	2
<b>Performance Characteristics</b> .....	<b>3</b>
Product Selection Guide .....	3
Optical Characteristics .....	3
Electrical and Thermal Characteristics .....	4
<b>Absolute Maximum Ratings</b> .....	<b>4</b>
<b>Characteristic Curves</b> .....	<b>5</b>
Spectral Power Distribution Characteristics .....	5
Light Output Characteristics .....	5
Forward Current Characteristics .....	6
Radiation Pattern Characteristics .....	7
<b>Product Bin and Labeling Definitions</b> .....	<b>8</b>
Decoding Product Bin Labeling .....	8
Luminous Flux Bins .....	8
Color Bin Definitions .....	9
Forward Voltage Bins .....	13
<b>Mechanical Dimensions</b> .....	<b>13</b>
<b>Reflow Soldering Guidelines</b> .....	<b>14</b>
JEDEC Moisture Sensitivity .....	14
Solder Pad Design .....	15
<b>Packaging Information</b> .....	<b>15</b>
Pocket Tape Dimensions .....	15
Reel Dimensions .....	16

# General Product Information

## Product Test Conditions

LUXEON 3535L with CrispColor Technology LEDs are tested and binned with a 20ms monopulse of 100mA at a junction temperature,  $T_j$ , of 25°C.

## Part Number Nomenclature

Part numbers for LUXEON 3535L with CrispColor Technology follow the convention below:

L 1 3 5 - **A A H G** C A 3 5 0 0 0 **H 0**

Where:

- A A** – designates nominal ANSI CCT (27=2700K, 30=3000K, 33=3250K, 35=3500K, 40=4000K, 50=5000K)
- H G** – designates CrispColor (HG=High Gamut)
- H 0** – designates product family in standard parts (H=LUXEON 3535L HE)

Therefore, the following part number is used for a LUXEON 3535L HE with CrispColor Technology, 3000K:

L 1 3 5 - **3 0 H G** C A 3 5 0 0 0 **H 0**

## Lumen Maintenance

Please contact your local Sales Representative or Lumileds Technical Solutions Manager for more information about the long-term performance of this product.

## Environmental Compliance

Lumileds LLC is committed to providing environmentally friendly products to the solid-state lighting market. LUXEON 3535L with CrispColor Technology is compliant to the European Union directives on the restriction of hazardous substances in electronic equipment, namely the RoHS Directive 2011/65/EU and REACH Regulation (EC) 1907/2006. Lumileds LLC will not intentionally add the following restricted materials to its products: lead, mercury, cadmium, hexavalent chromium, polybrominated biphenyls (PBB) or polybrominated diphenyl ethers (PBDE).

# Performance Characteristics

## Product Selection Guide

Table 1. Product performance of LUXEON 3535L with CrispColor Technology at 100mA and 65mA,  $T_j=25^\circ\text{C}$ .

PRODUCT	NOMINAL CCT <sup>[1]</sup>	MINIMUM CRI <sup>[2, 3]</sup>	LUMINOUS FLUX <sup>[2]</sup> (lm)		TYPICAL LUMINOUS EFFICACY (lm/W)	TYPICAL LUMINOUS FLUX (lm)	TYPICAL LUMINOUS EFFICACY (lm/W)	PART NUMBER
			MINIMUM	TYPICAL				
			100mA					
LUXEON 3535L HE	2700K	90	28	32	113	22	121	L135-27HGCA35000H0
	3000K	90	32	36	127	24	132	L135-30HGCA35000H0
	3250K	90	34	38	134	26	143	L135-33HGCA35000H0
	3500K	90	34	38	134	26	143	L135-35HGCA35000H0
	4000K	90	36	39	137	27	149	L135-40HGCA35000H0
	5000K	90	36	40	141	27	149	L135-50HGCA35000H0

**Notes for Table 1:**

1. Correlated color temperature is based upon mounted die on highly reflective surface at  $T_j=85^\circ\text{C}$ .
2. Typical CRI is approximately 2 points higher than the minimum CRI specified, but this is not guaranteed.
3. Lumileds maintains a tolerance of  $\pm 2$  on CRI and  $\pm 6.5\%$  on luminous flux measurements.

## Optical Characteristics

Table 2. Optical characteristics for LUXEON 3535L with CrispColor Technology at 100mA,  $T_j=85^\circ\text{C}$ .

PART NUMBER	TYPICAL TOTAL INCLUDED ANGLE <sup>[1]</sup>	TYPICAL VIEWING ANGLE <sup>[2]</sup>
L135-xxHGCA35000H0	140°	115°

**Notes for Table 2:**

1. Total angle at which 90% of total luminous flux is captured.
2. Viewing angle is the off axis angle from the LED centerline where the luminous intensity is  $\frac{1}{2}$  of the peak value.

## Electrical and Thermal Characteristics

Table 3. Electrical and thermal characteristics for LUXEON 3535L with CrispColor Technology at 100mA, T<sub>j</sub>=25°C.

PART NUMBER	FORWARD VOLTAGE <sup>[1]</sup> (V <sub>f</sub> )			TYPICAL TEMPERATURE COEFFICIENT OF FORWARD VOLTAGE <sup>[2]</sup> (mV/°C)	TYPICAL THERMAL RESISTANCE—JUNCTION TO SOLDER PAD (°C/W)
	MINIMUM	TYPICAL	MAXIMUM		
L135-XXHGCA35000H0	2.7	2.78	3.1	-2 to -4	18.0

**Notes for Table 3:**

1. Lumileds maintains a tolerance of ±0.06V on forward voltage measurements.
2. Measured between 25°C and 110°C.

## Absolute Maximum Ratings

Table 4. Absolute maximum ratings for LUXEON 3535L with CrispColor Technology.

PARAMETER	MAXIMUM PERFORMANCE
DC Forward Current <sup>[1, 2]</sup>	300mA
Peak Pulsed Forward Current <sup>[1, 3]</sup>	350mA
LED Junction Temperature <sup>[1]</sup> (DC & Pulse)	125°C
ESD Sensitivity (ANSI/ESDA/JEDEC JS-001-2012)	Class 2
Operating Case Temperature	-40°C to 105°C
LED Storage Temperature	-40°C to 105°C
Soldering Temperature	JEDEC 020c 260°C
Allowable Reflow Cycles	3
Reverse Voltage (V <sub>reverse</sub> ) <sup>[4, 5]</sup>	-5V

**Notes for Table 4:**

1. Residual periodic variations due to power conversion from alternating current (AC) to direct current (DC), also called "ripple," are acceptable if the following conditions are met:
  - The frequency of the ripple current is 100Hz or higher
  - The average current for each cycle does not exceed the maximum allowable DC forward current
  - The maximum amplitude of the ripple does not exceed the maximum peak pulsed forward current
2. At 10% duty cycle with pulse width of 10ms.
3. Proper current derating must be observed to maintain the junction temperature below the maximum allowable junction temperature.
4. Transient reverse voltages and surge currents due to electrical switching or supply interruptions are acceptable if these events do not last for more than 10ms, the amplitude of the reverse voltage does not exceed 5V and the reverse current is less than 220uA
5. Max 5V reverse for up to 10s is an acceptable beginning of life, one time test condition.

# Characteristic Curves

## Spectral Power Distribution Characteristics

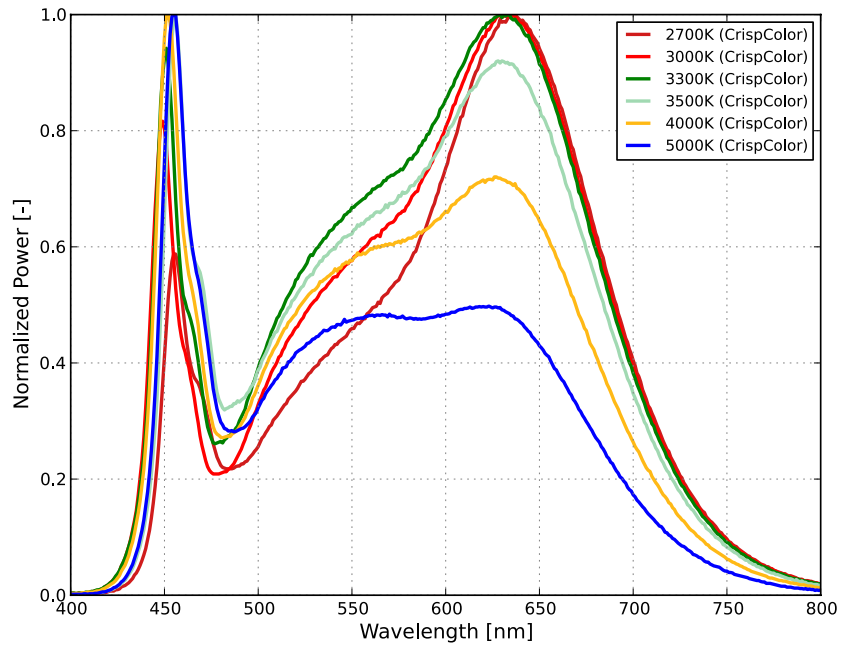

Figure 1. Typical normalized power vs. wavelength for 90CRI LUXEON 3535L with CrispColor Technology at 100mA, T<sub>j</sub>=25°C.

## Light Output Characteristics

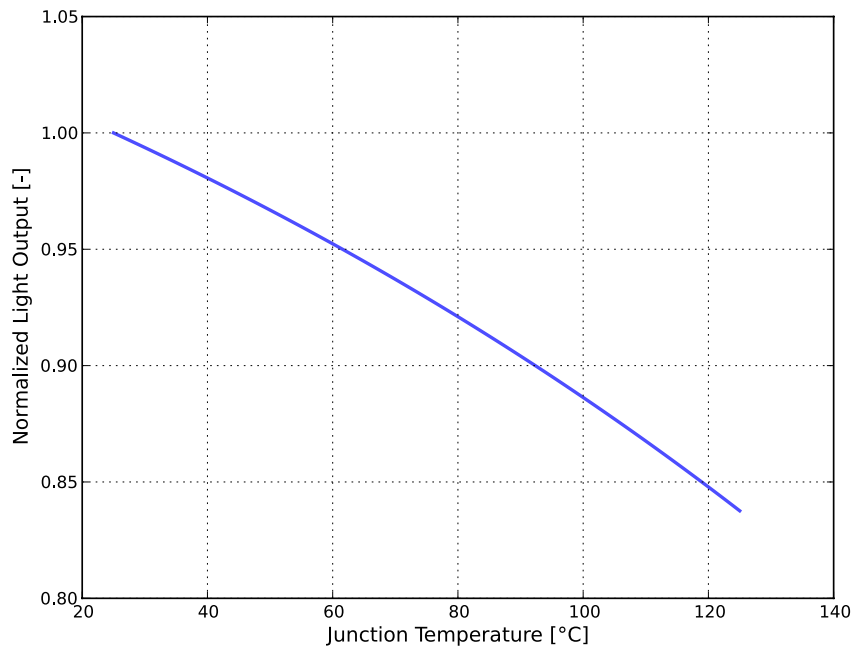

Figure 2. Typical normalized light output vs. junction temperature for LUXEON 3535L with CrispColor Technology at 100mA.

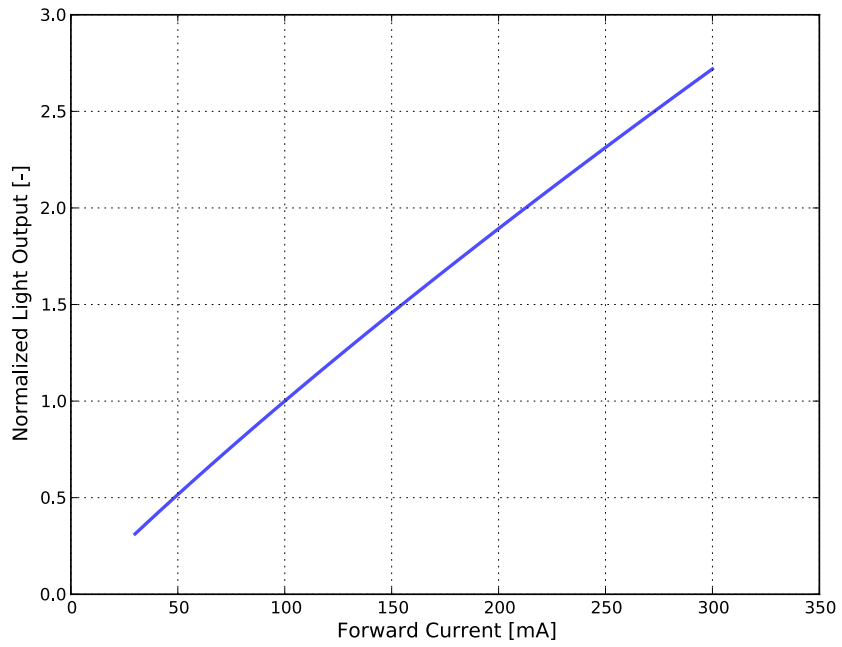

Figure 3. Typical normalized light output vs. forward current for LUXEON 3535L with CrispColor Technology at  $T_j=25^\circ\text{C}$ .

## Forward Current Characteristics

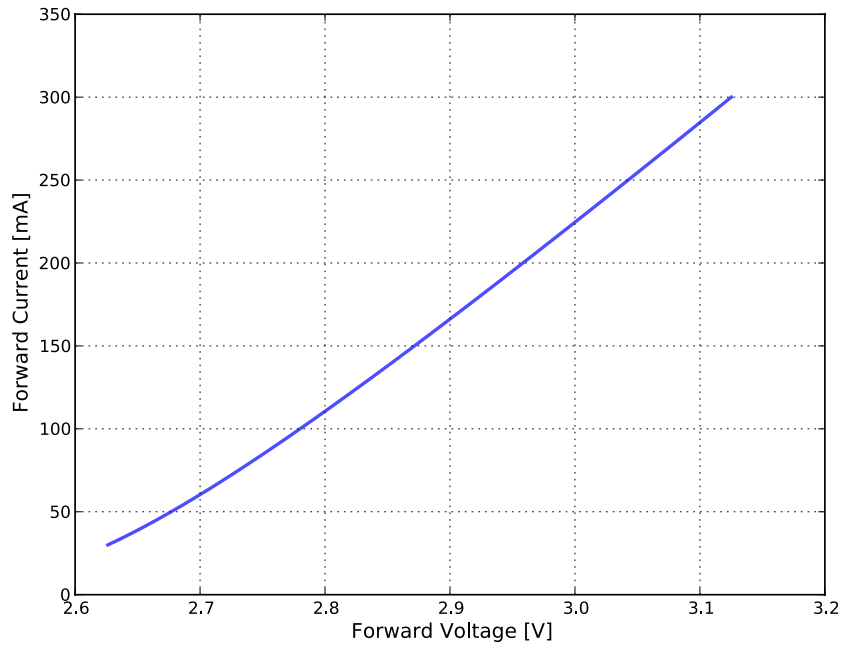

Figure 4. Typical forward current vs. forward voltage for LUXEON 3535L with CrispColor Technology at  $T_j=25^\circ\text{C}$ .

# Radiation Pattern Characteristics

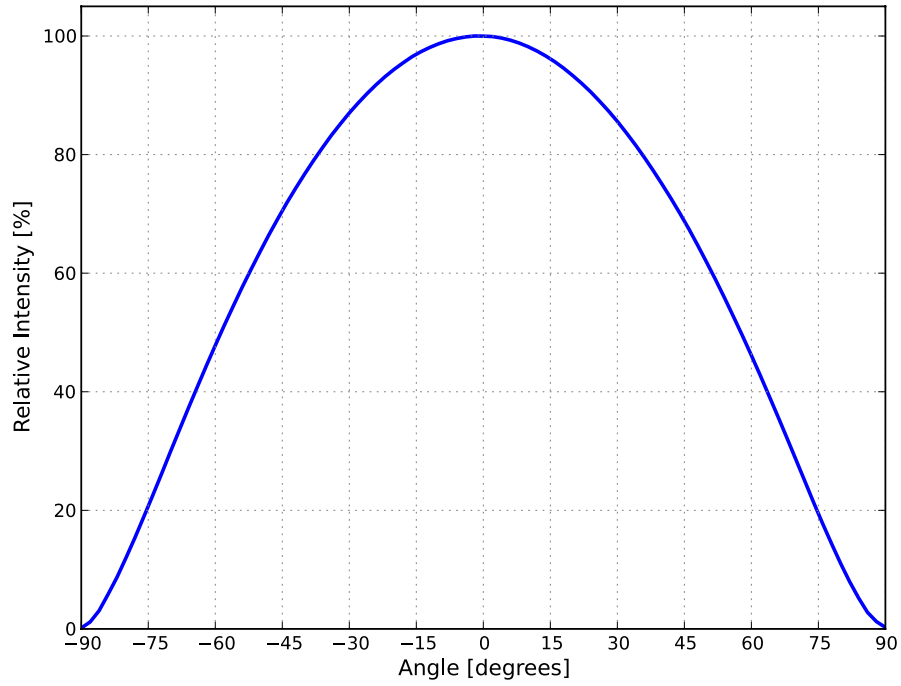

Figure 5. Typical radiation pattern for LUXEON 3535L with CrispColor Technology at 100mA,  $T_j=25^{\circ}\text{C}$ .

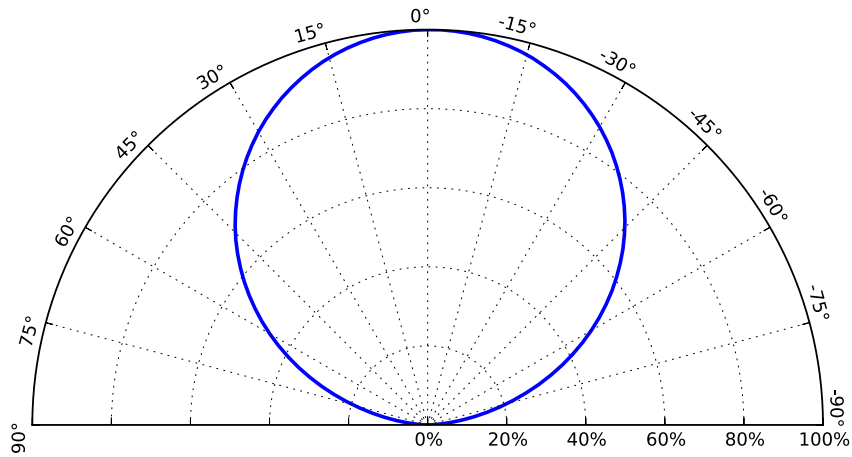

Figure 6. Typical polar radiation pattern for LUXEON 3535L with CrispColor Technology at 100mA,  $T_j=25^{\circ}\text{C}$ .



# Product Bin and Labeling Definitions

## Decoding Product Bin Labeling

In the manufacturing of semiconductor products, there are variations in performance around the average values given in the technical datasheet. For this reason, Lumileds bins LED components for luminous flux or radiometric power, color point, peak or dominant wavelength and forward voltage.

LUXEON 3535L with CrispColor Technology LEDs are labeled using a 4 or 5-digit alphanumeric CAT code following the format below:

**A B C D** or **A x B C D**

Where:

- A** – designates luminous flux bin (example: M=36 to 40 lumens, Q=44 to 48 lumens)
- x** – designates internal Lumileds code
- B C** – designates color bin (example: 7D, 7E, 7F, 7G, 7H) for 3000K parts
- D** – designates forward voltage bin (example: S=2.70 to 2.80V, T=2.80 to 2.90V)

Therefore, a LUXEON 3535L with CrispColor Technology with a lumen range of 36 to 40, color bin of 7D and a forward voltage range of 2.80 to 2.90V has the following CAT code:

**M 7 D T**

## Luminous Flux Bins

Table 5 lists the standard photometric luminous flux bins for LUXEON 3535L with CrispColor Technology emitters. Although several bins are outlined, product availability in a particular bin varies by production run and by product performance. Not all bins are available in all CCTs.

Table 5. Luminous flux bin definitions for LUXEON 3535L with CrispColor Technology.

PRODUCT	BIN	LUMINOUS FLUX <sup>(1)</sup> (lm)	
		MINIMUM	MAXIMUM
LUXEON 3535L HE	K	28	32
	L	32	36
	M	36	40
	P	40	44
	Q	44	48

Notes for Table 5:

1. Lumileds maintains a tolerance of  $\pm 6.5\%$  on luminous flux measurements.

# Color Bin Definitions

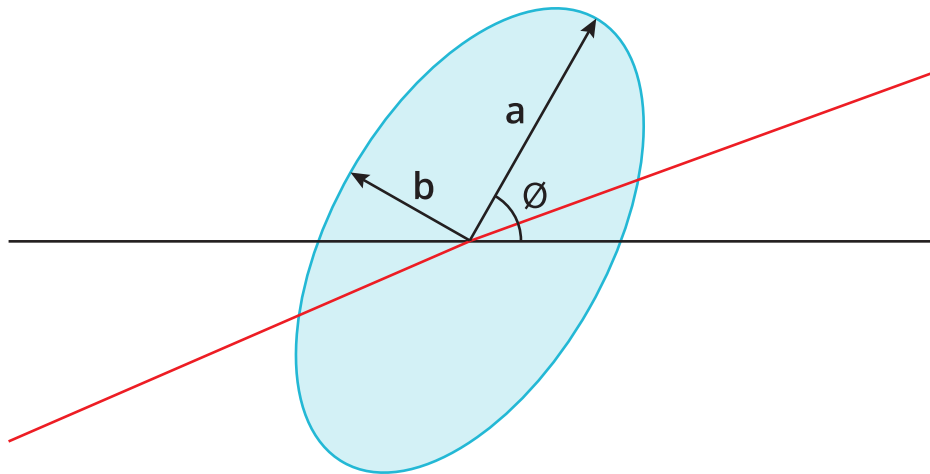

Figure 7. 3- and 5-step MacAdam ellipse illustration for Tables 6a-6f.

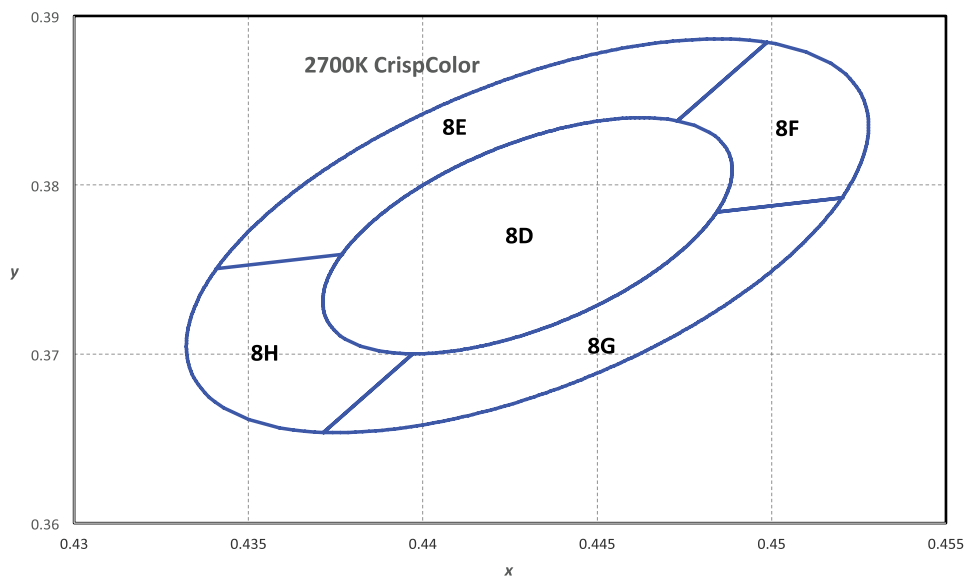

Figure 8a. 1/5<sup>th</sup> color bin structure for LUXEON 3535L with CrispColor Technology 2700K at  $T_j=25^\circ\text{C}$ .

Table 6a. 3- and 5-step MacAdam ellipse color bin definitions for LUXEON 3535L with CrispColor Technology 2700K at  $T_j=25^\circ\text{C}$ .

NOMINAL CCT	COLOR SPACE	CENTER POINT <sup>[1]</sup> (cx, cy)	MAJOR AXIS, a	MINOR AXIS, b	ELLIPSE ROTATION ANGLE, $\theta$
2700K	Single 3-step MacAdam ellipse	(0.443 0.377)	0.0081	0.0042	53.7°
2700K	Single 5-step MacAdam ellipse	(0.443 0.377)	0.0135	0.0070	53.7°

Notes for Table 6a:

1. Lumileds maintains a tolerance of  $\pm 0.007$  on x and y color coordinates in the CIE 1931 color space.

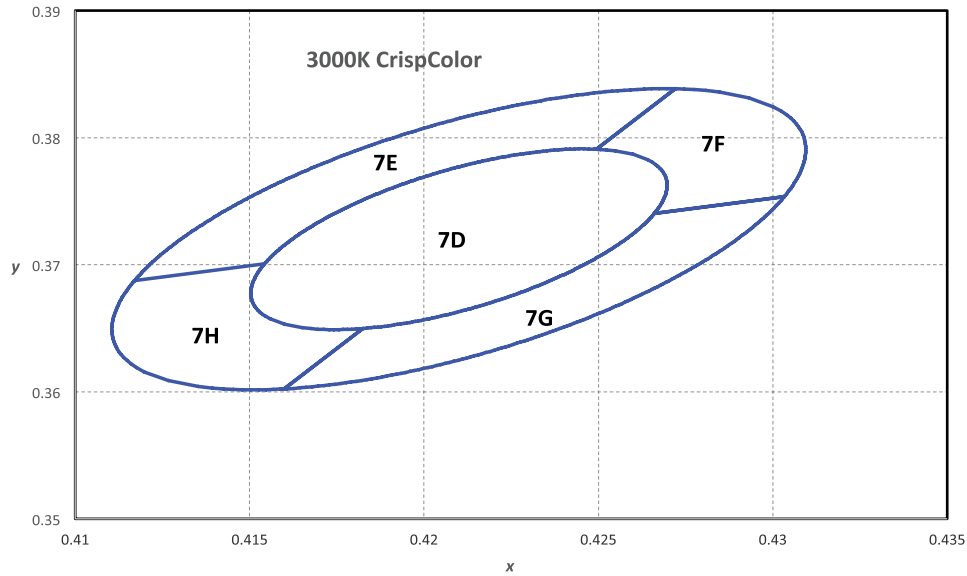

Figure 8b. 1/5<sup>th</sup> color bin structure for LUXEON 3535L with CrispColor Technology 3000K at  $T_j=25^\circ\text{C}$ .

Table 6b. 3- and 5-step MacAdam ellipse color bin definitions for LUXEON 3535L with CrispColor Technology 3000K at  $T_j=25^\circ\text{C}$ .

NOMINAL CCT	COLOR SPACE	CENTER POINT <sup>[1]</sup> (cx, cy)	MAJOR AXIS, a	MINOR AXIS, b	ELLIPSE ROTATION ANGLE, $\theta$
3000K	Single 3-step MacAdam ellipse	(0.421, 0.372)	0.00834	0.00408	53.22°
3000K	Single 5-step MacAdam ellipse	(0.421, 0.372)	0.01390	0.00680	53.22°

Notes for Table 6b:

1. Lumileds maintains a tolerance of  $\pm 0.007$  on x and y color coordinates in the CIE 1931 color space.

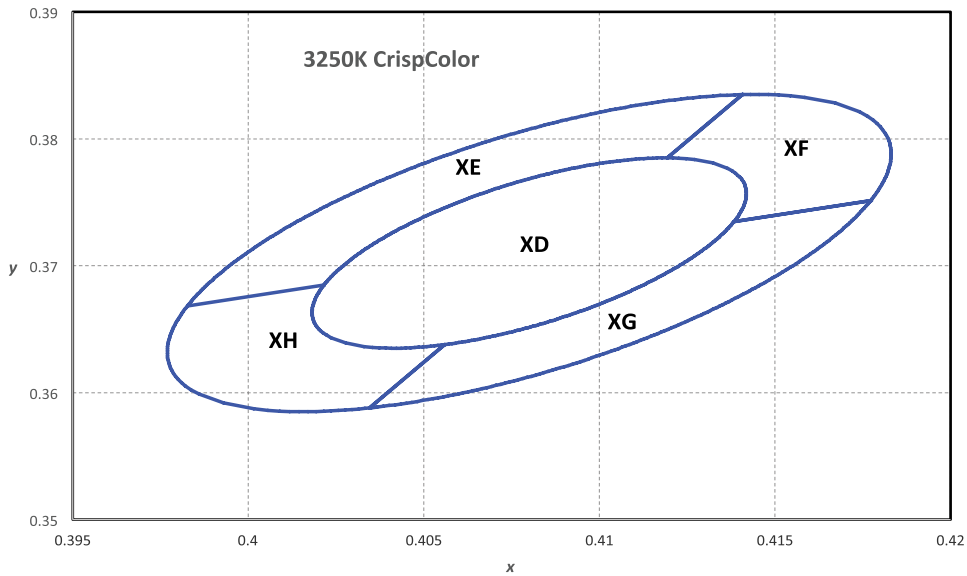

Figure 8c. 1/5<sup>th</sup> color bin structure for LUXEON 3535L with CrispColor Technology 3250K at  $T_j=25^\circ\text{C}$ .

Table 6c. 3- and 5-step MacAdam ellipse color bin definitions for LUXEON 3535L with CrispColor Technology 3250K at  $T_j=25^\circ\text{C}$ .

NOMINAL CCT	COLOR SPACE	CENTER POINT <sup>[1]</sup> (cx, cy)	MAJOR AXIS, a	MINOR AXIS, b	ELLIPSE ROTATION ANGLE, $\theta$
3250K	Single 3-step MacAdam ellipse	(0.408, 0.371)	0.00881	0.00411	53.61°
3250K	Single 5-step MacAdam ellipse	(0.408, 0.371)	0.01468	0.00685	53.61°

Notes for Table 6c:

1. Lumileds maintains a tolerance of  $\pm 0.007$  on x and y color coordinates in the CIE 1931 color space.

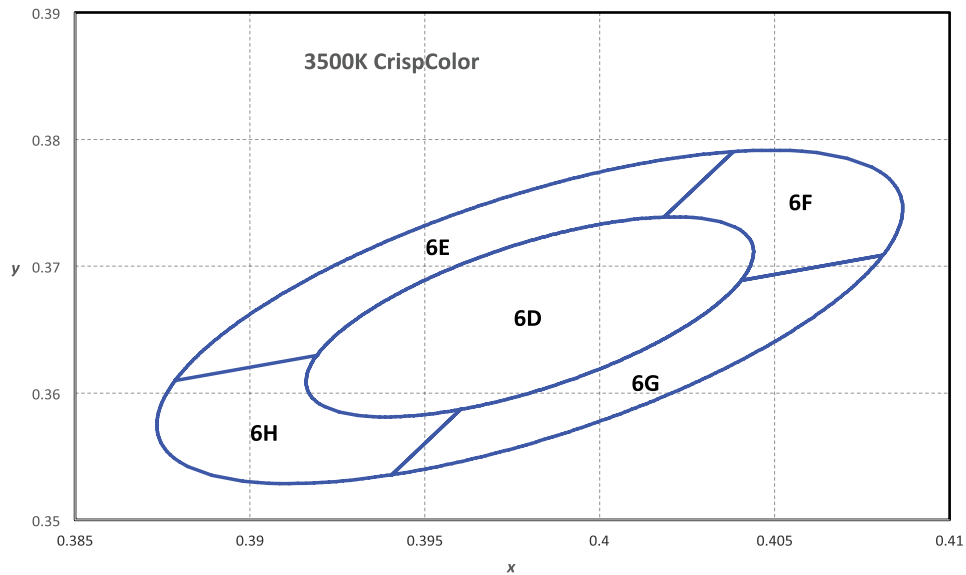

Figure 8d. 1/5<sup>th</sup> color bin structure for LUXEON 3535L with CrispColor Technology 3500K at  $T_j=25^\circ\text{C}$ .

Table 6d. 3- and 5-step MacAdam ellipse color bin definitions for LUXEON 3535L with CrispColor Technology 3500K at  $T_j=25^\circ\text{C}$ .

NOMINAL CCT	COLOR SPACE	CENTER POINT <sup>[1]</sup> (cx, cy)	MAJOR AXIS, a	MINOR AXIS, b	ELLIPSE ROTATION ANGLE, $\theta$
3500K	Single 3-step MacAdam ellipse	(0.398, 0.366)	0.00927	0.00414	54.00°
3500K	Single 5-step MacAdam ellipse	(0.398, 0.366)	0.01545	0.00690	54.00°

Notes for Table 6d:

1. Lumileds maintains a tolerance of  $\pm 0.007$  on x and y color coordinates in the CIE 1931 color space.

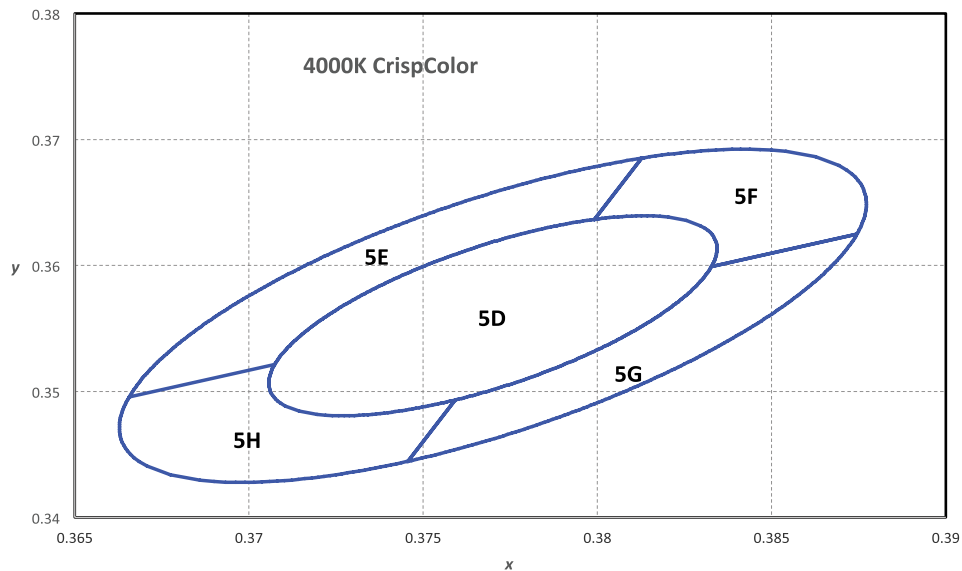

Figure 8e. 1/5<sup>th</sup> color bin structure for LUXEON 3535L with CrispColor Technology 4000K at  $T_j=25^\circ\text{C}$ .

Table 6e. 3- and 5-step MacAdam ellipse color bin definitions for LUXEON 3535L with CrispColor Technology 4000K at  $T_j=25^\circ\text{C}$ .

NOMINAL CCT	COLOR SPACE	CENTER POINT <sup>[1]</sup> (cx, cy)	MAJOR AXIS, a	MINOR AXIS, b	ELLIPSE ROTATION ANGLE, $\theta$
4000K	Single 3-step MacAdam ellipse	(0.377, 0.356)	0.00939	0.00402	53.72°
4000K	Single 5-step MacAdam ellipse	(0.377, 0.356)	0.01565	0.00670	53.72°

Notes for Table 6e:

1. Lumileds maintains a tolerance of  $\pm 0.007$  on x and y color coordinates in the CIE 1931 color space.

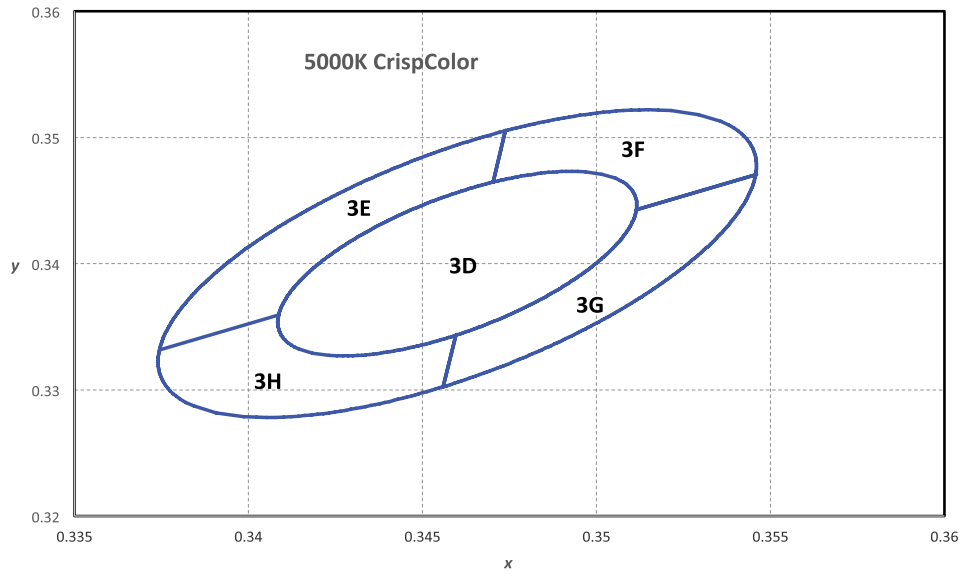

Figure 8f. 1/5<sup>th</sup> color bin structure for LUXEON 3535L with CrispColor Technology 5000K at  $T_j=25^\circ\text{C}$ .

Table 6f. 3- and 5-step MacAdam ellipse color bin definitions for LUXEON 3535L with CrispColor Technology 5000K at  $T_j=25^\circ\text{C}$ .

NOMINAL CCT	COLOR SPACE	CENTER POINT <sup>[1]</sup> (cx, cy)	MAJOR AXIS, a	MINOR AXIS, b	ELLIPSE ROTATION ANGLE, $\theta$
5000K	Single 3-step MacAdam ellipse	(0.346, 0.340)	0.00822	0.00354	59.62°
5000K	Single 5-step MacAdam ellipse	(0.346, 0.340)	0.01370	0.00590	59.62°

Notes for Table 6f:

1. Lumileds maintains a tolerance of  $\pm 0.007$  on x and y color coordinates in the CIE 1931 color space.

Table 7. Correlated color temperature bin definitions for LUXEON 3535L with CrispColor Technology.

BIN	CCT
3	5000K
5	4000K
6	3500K
x	3250K
8	2700K

Table 8. MacAdam ellipse color bin definitions for LUXEON 3535L with CrispColor Technology.

BIN	SDCM/WAVELENGTH (nm)
3	3-step MacAdam ellipse
U	3-step MacAdam ellipse
L	3-step MacAdam ellipse
A	5-step MacAdam ellipse
B	5-step MacAdam ellipse
C	5-step MacAdam ellipse
D	5-step MacAdam ellipse

# Forward Voltage Bins

Table 9. Forward voltage bin definitions for LUXEON 3535L with CrispColor Technology.

PRODUCT	BIN	FORWARD VOLTAGE <sup>(1)</sup> (V <sub>f</sub> )	
		MINIMUM	MAXIMUM
LUXEON 3535L HE	S	2.7	2.8
	T	2.8	2.9
	V	2.9	3.0
	W	3.0	3.1
	X	3.1	3.2
	Y	3.2	3.3

**Notes for Table 9:**

1. Lumileds maintains a tolerance of ±0.06V on forward voltage measurements.

# Mechanical Dimensions

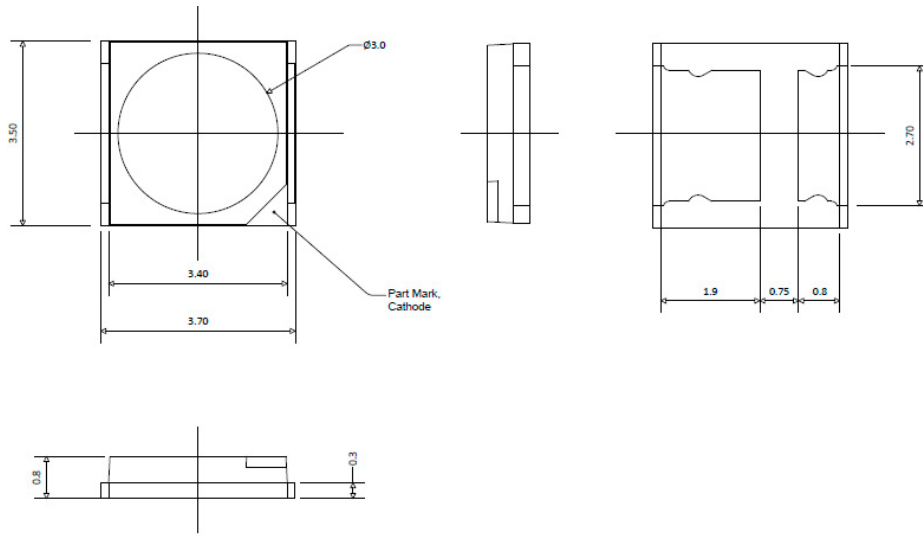

Figure 9. Mechanical dimensions for LUXEON 3535L with CrispColor Technology.

**Notes for Figure 9:**

1. Drawings are not to scale.
2. All dimensions are in millimeters.

# Reflow Soldering Guidelines

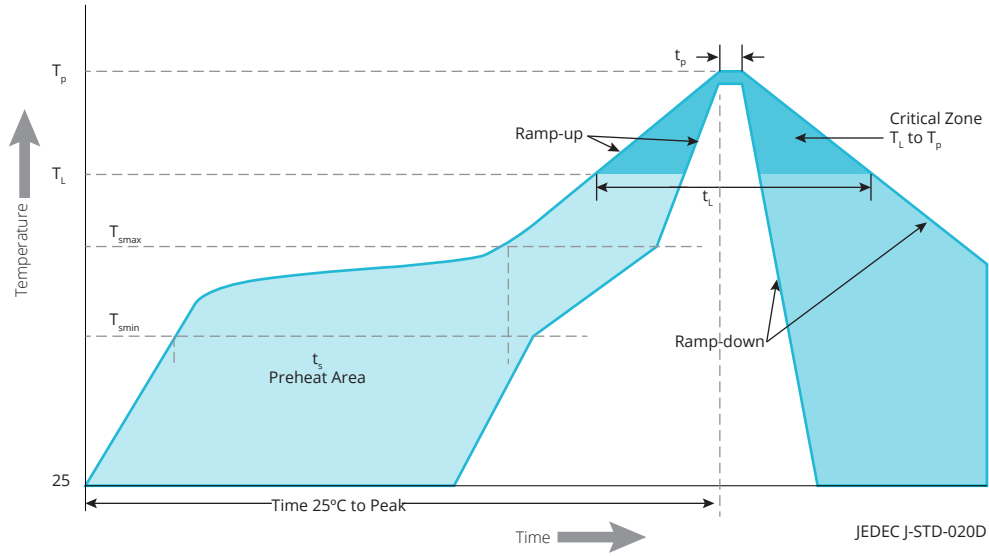

Figure 10. Visualization of the acceptable reflow temperature profile as specified in Table 10.

Table 10. Reflow profile characteristics for LUXEON 3535L with CrispColor Technology.

PROFILE FEATURE	LEAD-FREE ASSEMBLY
Preheat Minimum Temperature ( $T_{smin}$ )	150°C
Preheat Maximum Temperature ( $T_{smax}$ )	200°C
Preheat Time ( $t_{smin}$ to $t_{smax}$ )	60 to 120 seconds
Ramp-Up Rate ( $T_L$ to $T_p$ )	3°C / second maximum
Liquidus Temperature ( $T_L$ )	217°C
Time Maintained Above Temperature $T_L$ ( $t_t$ )	60 to 150 seconds
Peak / Classification Temperature ( $T_p$ )	260°C
Time Within 5°C of Actual Temperature ( $t_p$ )	20 to 40 seconds
Ramp-Down Rate ( $T_p$ to $T_L$ )	6°C / second maximum
Time 25°C to Peak Temperature	8 minutes maximum

## JEDEC Moisture Sensitivity

Table 11. Moisture sensitivity levels for LUXEON 3535L with CrispColor Technology.

LEVEL	FLOOR LIFE		SOAK REQUIREMENTS STANDARD	
	TIME	CONDITIONS	TIME	CONDITIONS
2	1 Year	≤30°C / 60% RH	168 Hours +5 / -0	85°C / 60% RH

# Solder Pad Design

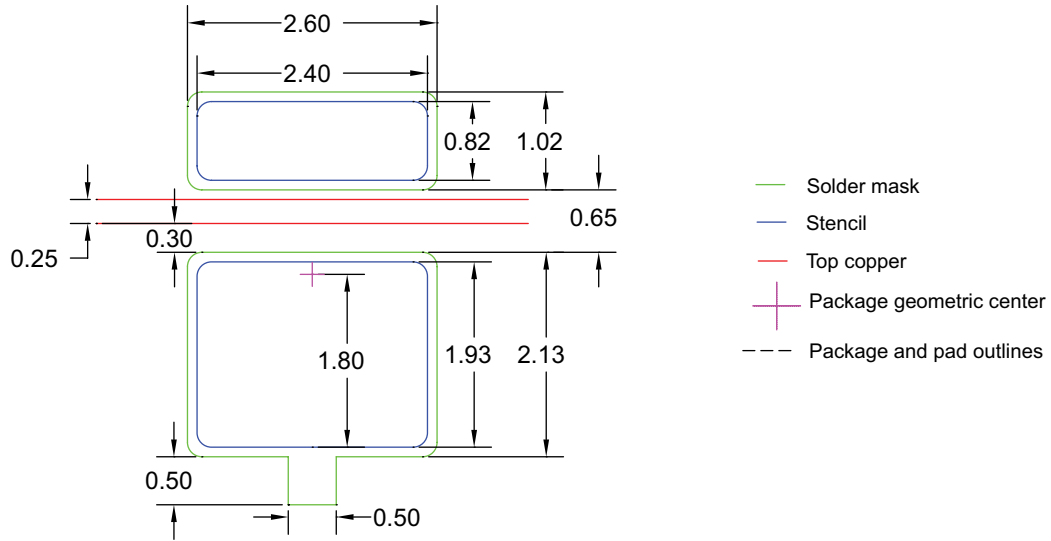

Figure 11. Recommended PCB solder pad layout for LUXEON 3535L with CrispColor Technology.

- Notes for Figure 11:
1. Drawings are not to scale.
  2. All dimensions are in millimeters.

# Packaging Information

## Pocket Tape Dimensions

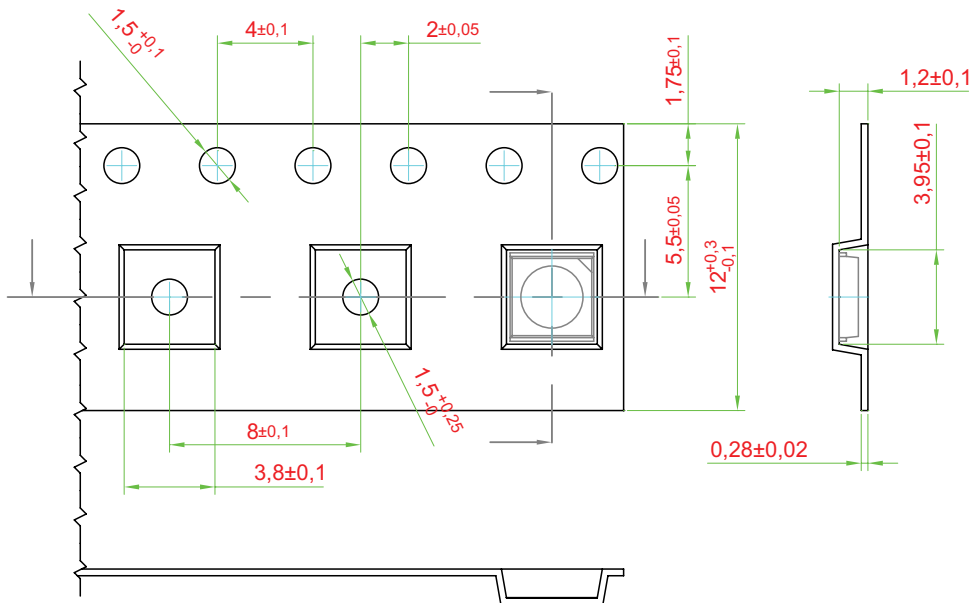

Figure 12. Pocket tape dimensions for LUXEON 3535L with CrispColor Technology.

- Notes for Figure 12:
1. Drawings are not to scale.
  2. All dimensions are in millimeters.



# Reel Dimensions

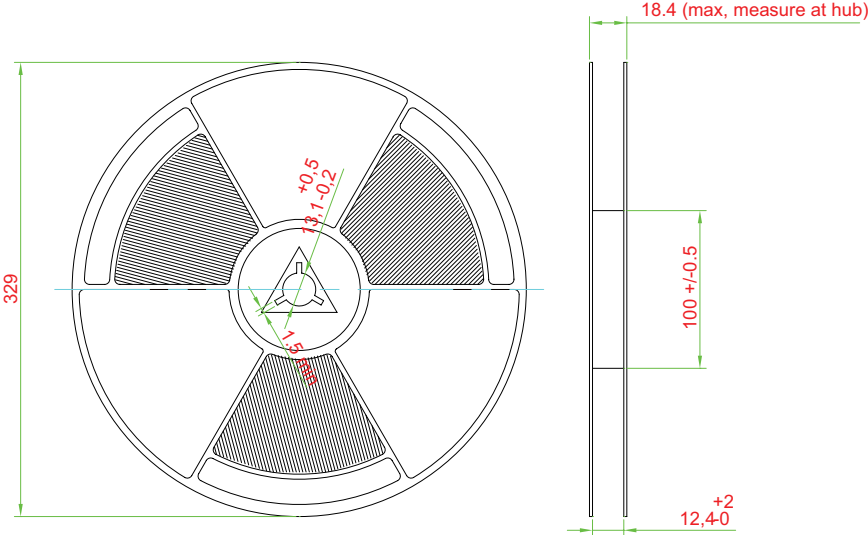

Figure 13. Reel dimensions for LUXEON 3535L with CrispColor Technology.

- Notes for Figure 13:
- 1. Drawings are not to scale.
  - 2. All dimensions are in millimeters.

## About Lumileds

Companies developing automotive, mobile, IoT and illumination lighting applications need a partner who can collaborate with them to push the boundaries of light. With over 100 years of inventions and industry firsts, Lumileds is a global lighting solutions company that helps customers around the world deliver differentiated solutions to gain and maintain a competitive edge. As the inventor of Xenon technology, a pioneer in halogen lighting and the leader in high performance LEDs, Lumileds builds innovation, quality and reliability into its technology, products and every customer engagement. Together with its customers, Lumileds is making the world safer, better and more beautiful—with light.

To learn more about our lighting solutions, visit [lumileds.com](http://lumileds.com).



---

©2017 Lumileds Holding B.V. All rights reserved.  
LUXEON is a registered trademark of the Lumileds Holding B.V. in the United States and other countries.  
[lumileds.com](http://lumileds.com)

Neither Lumileds Holding B.V. nor its affiliates shall be liable for any kind of loss of data or any other damages, direct, indirect or consequential, resulting from the use of the provided information and data. Although Lumileds Holding B.V. and/or its affiliates have attempted to provide the most accurate information and data, the materials and services information and data are provided "as is," and neither Lumileds Holding B.V. nor its affiliates warrants or guarantees the contents and correctness of the provided information and data. Lumileds Holding B.V. and its affiliates reserve the right to make changes without notice. You as user agree to this disclaimer and user agreement with the download or use of the provided materials, information and data. A listing of Lumileds product/patent coverage may be accessed at [lumileds.com/patents](http://lumileds.com/patents).