

**Phase Leg & Dual Common Emitter
Power Module**

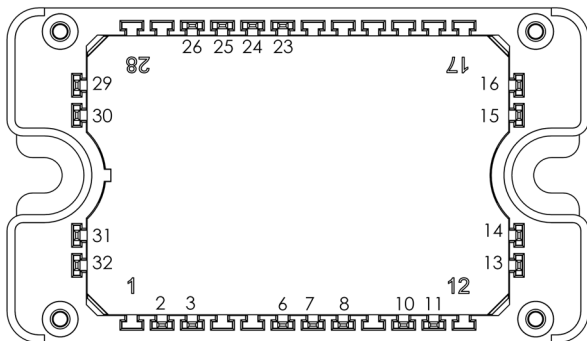
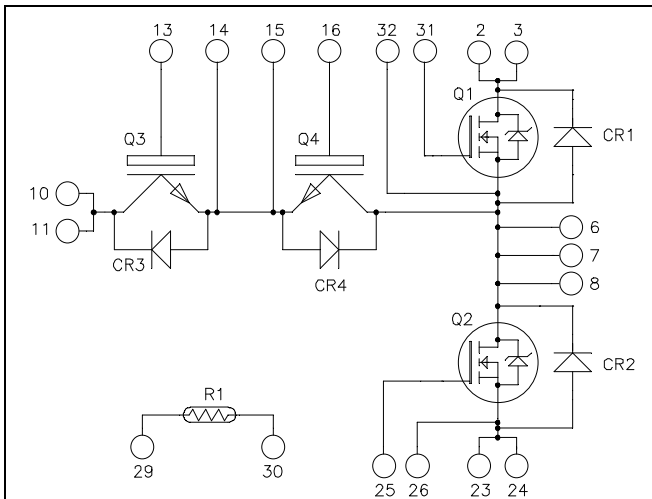

All multiple inputs and outputs must be shorted together
10/11 ; 23/24 ; 25/26 ; ...

SiC MOSFET (Q1, Q2):

$V_{CES} = 1200V$; $R_{DS(on)} = 34m\Omega$ max @ $T_j = 25^\circ C$

Trench & Field Stop IGBT3 (Q3, Q4):

$V_{CES} = 600V$; $I_C = 50A$ @ $T_c = 100^\circ C$

Application

- Solar converter
- Uninterruptible Power Supplies

Features

- **Q1, Q2 SiC Power MOSFET**
 - Low $R_{DS(on)}$
 - High temperature performance
- **Q3, Q4 Trench + field Stop IGBT3**
 - Low voltage drop
 - Low tail current
 - Switching frequency up to 20 kHz
- **SiC Schottky Diode (CR1 to CR4)**
 - Zero reverse recovery
 - Zero forward recovery
 - Temperature Independent switching behavior
 - Positive temperature coefficient on VF

- Kelvin emitter for easy drive
- Very low stray inductance
- AlN substrate for improved thermal performance
- Internal thermistor for temperature monitoring

Benefits

- Stable temperature behavior
- Very rugged
- Solderable terminals for easy PCB mounting
- Direct mounting to heatsink (isolated package)
- Low junction to case thermal resistance
- Easy paralleling due to positive T_C of V_{CESat}
- Low profile

All ratings @ $T_j = 25^\circ C$ unless otherwise specified

CAUTION: These Devices are sensitive to Electrostatic Discharge. Proper Handling Procedures Should Be Followed.
See application note APT0502 on www.microsemi.com

1. SiC MOSFET characteristics (Per MOSFET)
Absolute maximum ratings

Symbol	Parameter	Max ratings	Unit
V_{DSS}	Drain - Source Voltage	1200	V
I_D	Continuous Drain Current	$T_c = 25^\circ\text{C}$	73
		$T_c = 80^\circ\text{C}$	55
I_{DM}	Pulsed Drain Current	140	A
V_{GS}	Gate - Source Voltage	-10/+25	V
$R_{DS(on)}$	Drain - Source ON Resistance	34	m Ω
P_D	Power Dissipation	$T_c = 25^\circ\text{C}$	375
			W

Electrical Characteristics

Symbol	Characteristic	Test Conditions	Min	Typ	Max	Unit
I_{DSS}	Zero Gate Voltage Drain Current	$V_{GS} = 0V, V_{DS} = 1200V$			100	μA
$R_{DS(on)}$	Drain - Source on Resistance	$V_{GS} = 20V$ $I_D = 50A$	$T_j = 25^\circ\text{C}$	25	34	m Ω
			$T_j = 150^\circ\text{C}$	43		
$V_{GS(th)}$	Gate Threshold Voltage	$V_{GS} = V_{DS}, I_D = 12.5mA$	2.4	3		V
I_{GSS}	Gate - Source Leakage Current	$V_{GS} = 20V, V_{DS} = 0V$			600	nA

Dynamic Characteristics

Symbol	Characteristic	Test Conditions	Min	Typ	Max	Unit
C_{iss}	Input Capacitance	$V_{GS} = 0V$ $V_{DS} = 1000V$ $f = 1MHz$		2788		pF
C_{oss}	Output Capacitance			220		
C_{rss}	Reverse Transfer Capacitance			15		
Q_g	Total gate Charge	$V_{GS} = -5/20V$ $V_{Bus} = 800V$ $I_D = 50A$		161		nC
Q_{gs}	Gate - Source Charge			46		
Q_{gd}	Gate - Drain Charge			50		
$T_{d(on)}$	Turn-on Delay Time	$V_{GS} = -2/+20V$ $V_{Bus} = 800V$ $I_D = 50A$ $R_L = 16\Omega; R_G = 20\Omega$		21		ns
T_r	Rise Time			19		
$T_{d(off)}$	Turn-off Delay Time			50		
T_f	Fall Time			30		
E_{on}	Turn on Energy	Inductive Switching $V_{GS} = -5/+20V$ $V_{Bus} = 600V$ $I_D = 50A$ $R_G = 20\Omega$	$T_j = 150^\circ\text{C}$	1.1		mJ
E_{off}	Turn off Energy			$T_j = 150^\circ\text{C}$	0.6	
R_{thJC}	Junction to Case Thermal Resistance				0.4	$^\circ\text{C/W}$

SiC diode ratings and characteristics (CR1 & CR2) (per diode)

Symbol	Characteristic	Test Conditions	Min	Typ	Max	Unit
V _{RRM}	Peak Repetitive Reverse Voltage				1200	V
I _{RM}	Reverse Leakage Current	V _R = 1200V	T _j = 25°C	10	200	μA
			T _j = 175°C	500		
I _F	DC Forward Current		T _c = 100°C	10		A
V _F	Diode Forward Voltage	I _F = 10A	T _j = 25°C	1.5	1.8	V
			T _j = 175°C	2.3		
Q _C	Total Capacitive Charge	I _F = 10A, V _R = 600V di/dt = 500A/μs		120		nC
C	Total Capacitance	f = 1MHz, V _R = 200V		115		pF
		f = 1MHz, V _R = 400V		85		
R _{thJC}	Junction to Case Thermal Resistance				1.1	°C/W

2. Trench & Field Stop IGBT3 (per IGBT)
Absolute maximum ratings

Symbol	Parameter	Max ratings	Unit
V _{CES}	Collector - Emitter Voltage	600	V
I _C	Continuous Collector Current	T _C = 25°C	105
		T _C = 100°C	50
I _{CM}	Pulsed Collector Current	T _C = 25°C	100
V _{GE}	Gate - Emitter Voltage	±20	V
P _D	Power Dissipation	T _C = 25°C	176
RBSOA	Reverse Bias Safe Operating Area	T _J = 150°C	100A @ 550V

Electrical Characteristics

Symbol	Characteristic	Test Conditions	Min	Typ	Max	Unit
I _{CES}	Zero Gate Voltage Collector Current	V _{GE} = 0V, V _{CE} = 600V			25	μA
V _{CE(sat)}	Collector Emitter Saturation Voltage	V _{GE} = 15V I _C = 50A	T _j = 25°C	1.5	1.9	V
			T _j = 150°C	1.7		
V _{GE(th)}	Gate Threshold Voltage	V _{GE} = V _{CE} , I _C = 600μA	5.0	5.8	6.5	V
I _{GES}	Gate - Emitter Leakage Current	V _{GE} = 20V, V _{CE} = 0V			600	nA

Dynamic Characteristics

<i>Symbol</i>	<i>Characteristic</i>	<i>Test Conditions</i>	<i>Min</i>	<i>Typ</i>	<i>Max</i>	<i>Unit</i>
C _{ies}	Input Capacitance	V _{GE} = 0V V _{CE} = 25V f = 1MHz		3150		pF
C _{oes}	Output Capacitance			200		
C _{res}	Reverse Transfer Capacitance			95		
Q _G	Gate charge	V _{GE} = ±15V, I _C = 50A V _{CE} = 300V		500		nC
T _{d(on)}	Turn-on Delay Time	Inductive Switching (25°C) V _{GE} = ±15V V _{Bus} = 300V I _C = 50A R _G = 8.2Ω		110		ns
T _r	Rise Time			45		
T _{d(off)}	Turn-off Delay Time			200		
T _f	Fall Time			40		
T _{d(on)}	Turn-on Delay Time	Inductive Switching (150°C) V _{GE} = ±15V V _{Bus} = 300V I _C = 50A R _G = 8.2Ω		120		ns
T _r	Rise Time			50		
T _{d(off)}	Turn-off Delay Time			250		
T _f	Fall Time			60		
E _{on}	Turn-on Switching Energy	V _{GE} = ±15V V _{Bus} = 300V I _C = 50A R _G = 8.2Ω	T _j = 25°C	0.2		mJ
			T _j = 150°C	0.26		
E _{off}	Turn-off Switching Energy	I _C = 50A R _G = 8.2Ω	T _j = 25°C	1.35		mJ
			T _j = 150°C	1.75		
I _{sc}	Short Circuit data	V _{GE} ≤ 15V ; V _{Bus} = 360V t _p ≤ 10μs ; T _j = 150°C		250		A
R _{thJC}	Junction to Case Thermal Resistance				0.68	°C/W

3. SiC diode ratings and characteristics (CR3 & CR4) (per diode)

<i>Symbol</i>	<i>Characteristic</i>	<i>Test Conditions</i>	<i>Min</i>	<i>Typ</i>	<i>Max</i>	<i>Unit</i>
V _{RRM}	Peak Repetitive Reverse Voltage				600	V
I _{RM}	Reverse Leakage Current	V _R = 600V	T _j = 25°C	20	120	μA
			T _j = 175°C	40	600	
I _F	DC Forward Current		T _c = 100°C	20		A
V _F	Diode Forward Voltage	I _F = 20A	T _j = 25°C	1.6	1.8	V
			T _j = 175°C	2	2.4	
Q _C	Total Capacitive Charge	I _F = 20A, V _R = 600V di/dt = 800A/μs		56		nC
C	Total Capacitance	f = 1MHz, V _R = 200V		130		pF
		f = 1MHz, V _R = 400V		100		
R _{thJC}	Junction to Case Thermal Resistance				1.1	°C/W

4. Temperature sensor NTC

Symbol	Characteristic	Min	Typ	Max	Unit
R ₂₅	Resistance @ 25°C		22		kΩ
ΔR ₂₅ /R ₂₅	Resistance tolerance			5	%
ΔB/B	Beta tolerance			3	
B _{25/100}	T ₂₅ = 298.16 K		3980		K

$$R_T = \frac{R_{25}}{\exp\left[B_{25/100}\left(\frac{1}{T_{25}} - \frac{1}{T}\right)\right]}$$

T: Thermistor temperature
 R_T: Thermistor value at T

5. Thermal and package characteristics

Symbol	Characteristic	Min	Max	Unit		
V _{ISOL}	RMS Isolation Voltage, any terminal to case t=1 min, 50/60Hz	4000		V		
T _J	Operating junction temperature range	SiC MOSFET	-40	150	°C	
		SiC diode + IGBT	-40	175		
T _{JOP}	Recommended junction temperature under switching conditions	-40	T _{Jmax} -25			
T _{STG}	Storage Temperature Range	-40	125			
T _C	Operating Case Temperature	-40	125			
Torque	Mounting torque	To heatsink	M4	2	3	N.m
Wt	Package Weight				110	g

Package outline (dimensions in mm)

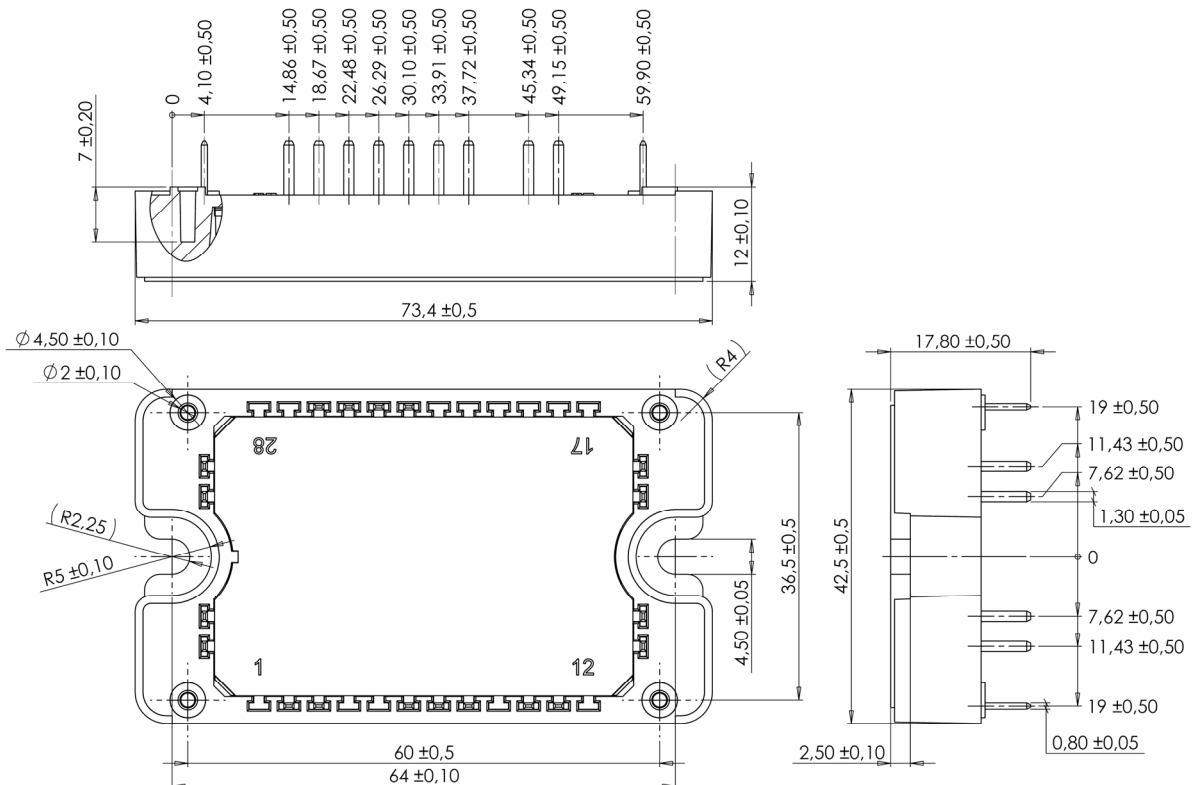

See application note 1906 - Mounting Instructions for SP3F Power Modules on www.microsemi.com

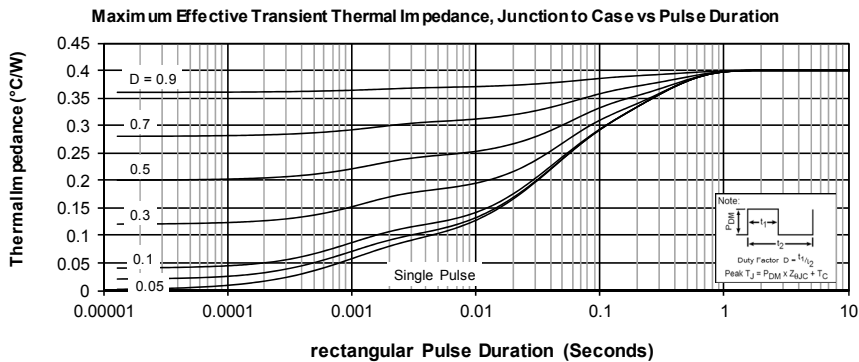
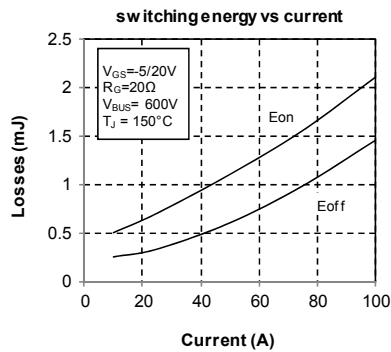
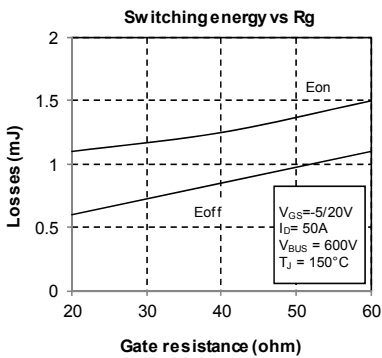
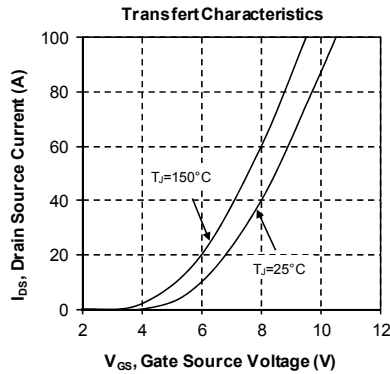
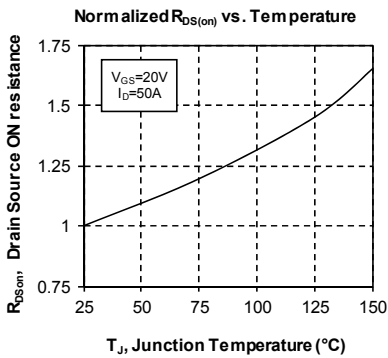
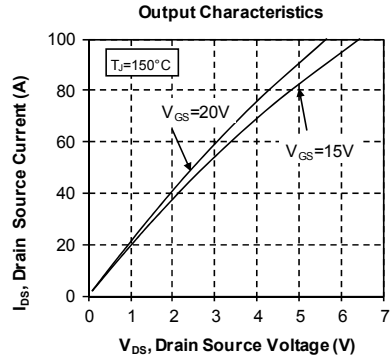
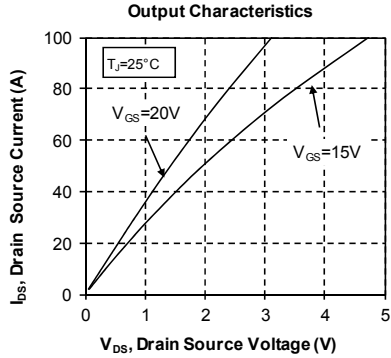
6. Typical performance curve
Q1, Q2 SiC MOSFET

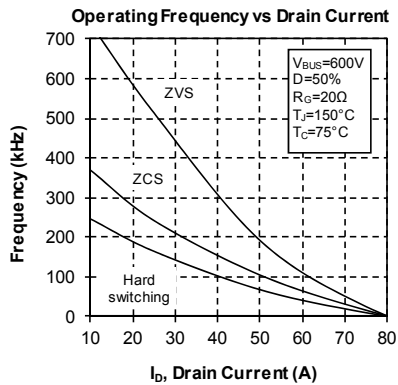
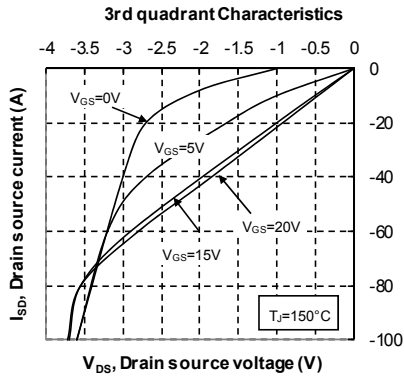
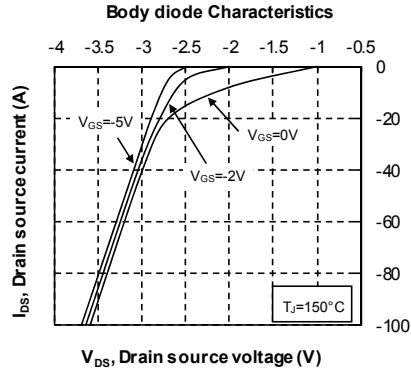
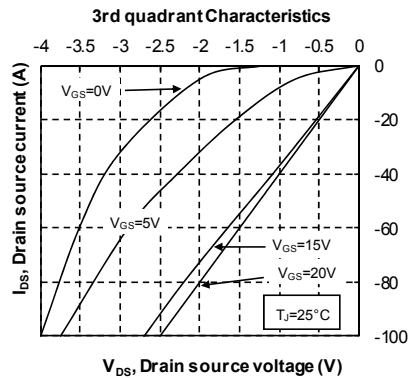
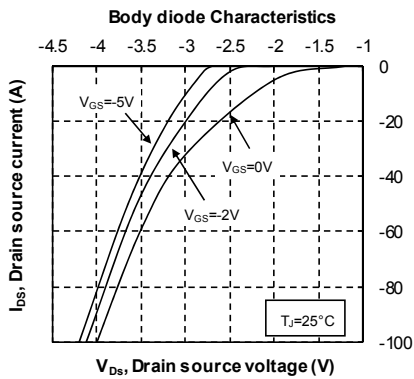
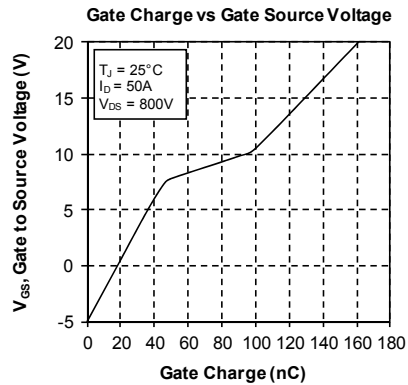
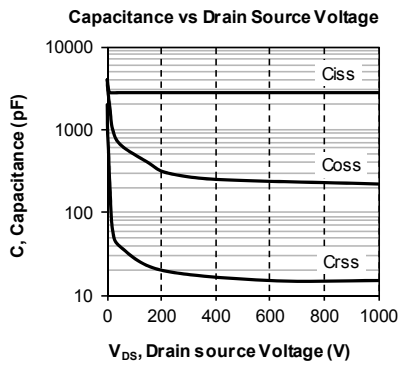

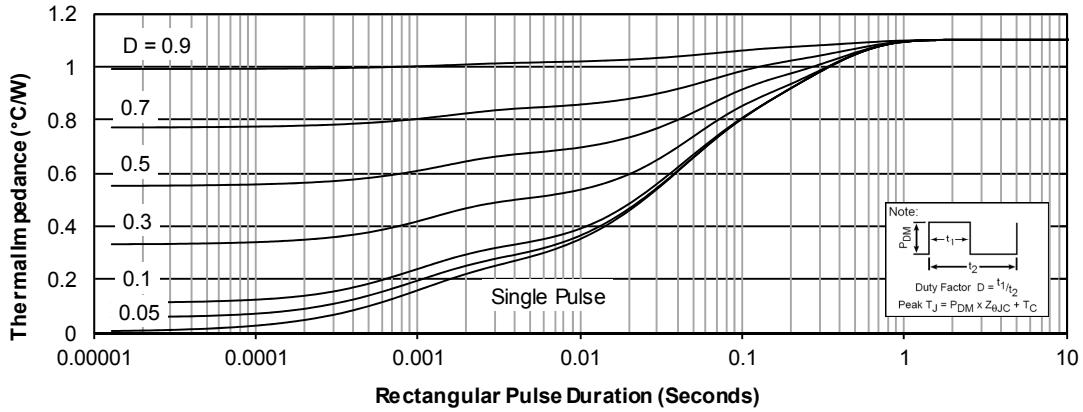
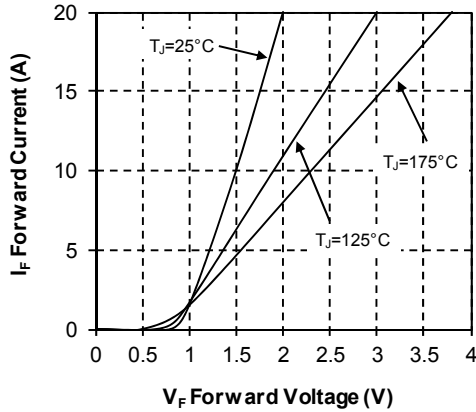
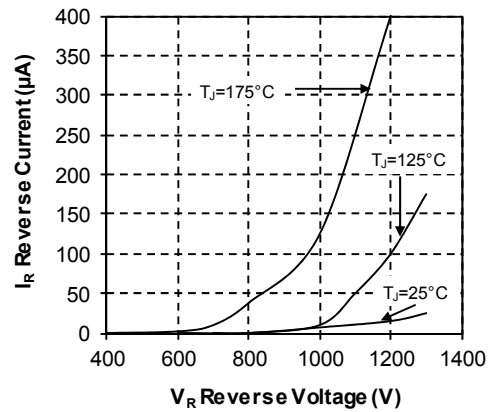
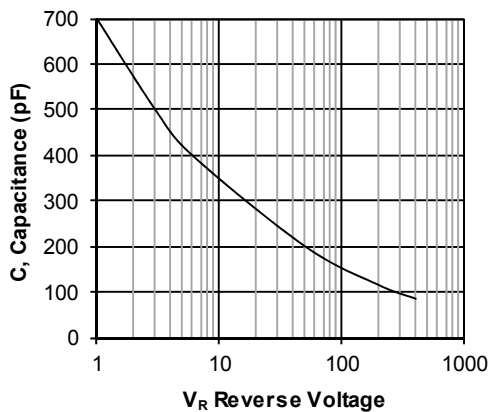
CR1 & CR2 SiC diode characteristics
Maximum Effective Transient Thermal Impedance, Junction to Case vs Pulse Duration

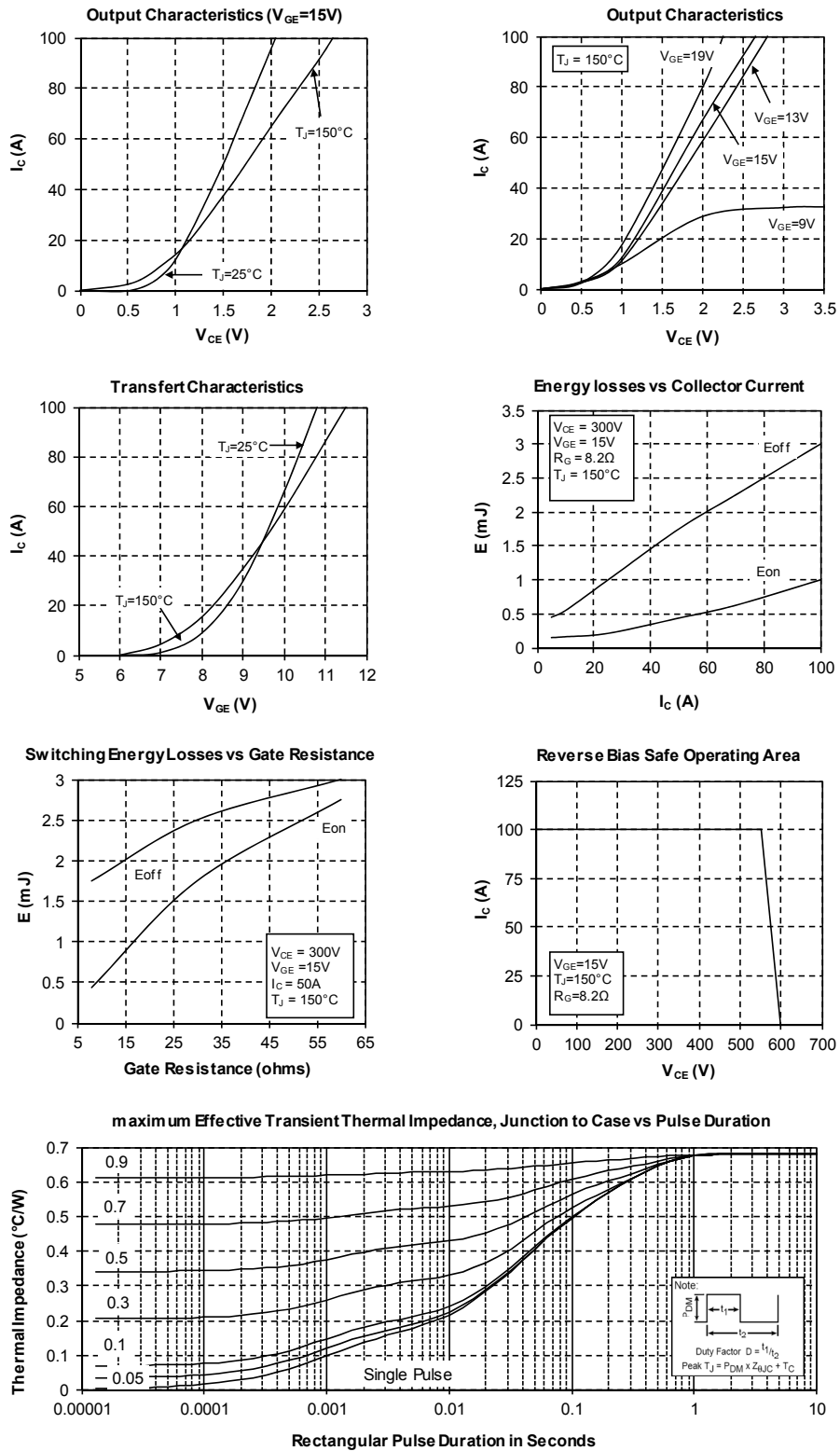
Forward Characteristics

Reverse Characteristics

Capacitance vs. Reverse Voltage

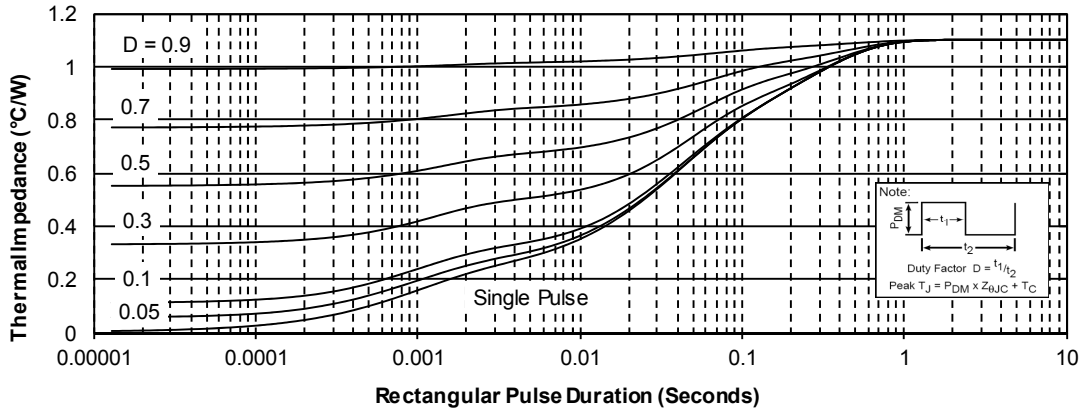
Q3, Q4 Trench + field stop IGBT3

CR3 & CR4 SiC diode characteristics

Maximum Effective Transient Thermal Impedance, Junction to Case vs Pulse Duration



Forward Characteristics

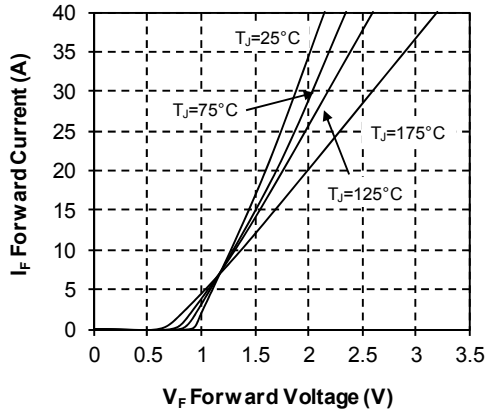

Reverse Characteristics

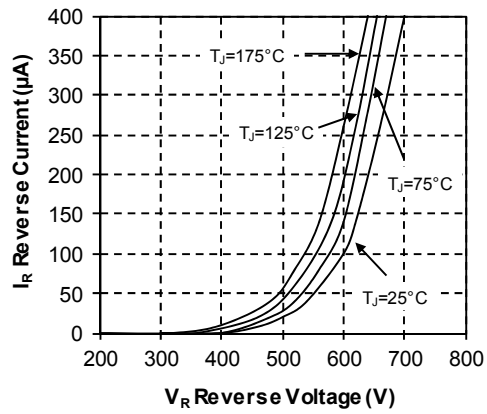

Capacitance vs. Reverse Voltage

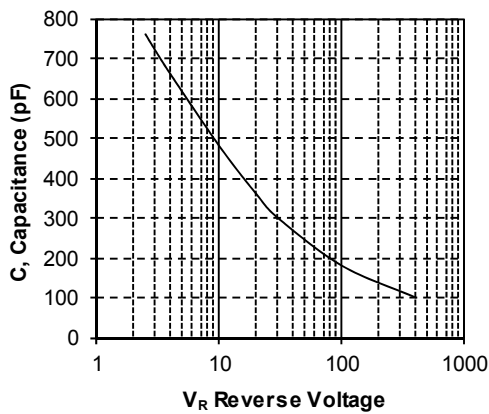

DISCLAIMER

The information contained in the document (unless it is publicly available on the Web without access restrictions) is PROPRIETARY AND CONFIDENTIAL information of Microsemi and cannot be copied, published, uploaded, posted, transmitted, distributed or disclosed or used without the express duly signed written consent of Microsemi. If the recipient of this document has entered into a disclosure agreement with Microsemi, then the terms of such Agreement will also apply. This document and the information contained herein may not be modified, by any person other than authorized personnel of Microsemi. No license under any patent, copyright, trade secret or other intellectual property right is granted to or conferred upon you by disclosure or delivery of the information, either expressly, by implication, inducement, estoppels or otherwise. Any license under such intellectual property rights must be approved by Microsemi in writing signed by an officer of Microsemi.

Microsemi reserves the right to change the configuration, functionality and performance of its products at anytime without any notice. This product has been subject to limited testing and should not be used in conjunction with life-support or other mission-critical equipment or applications. Microsemi assumes no liability whatsoever, and Microsemi disclaims any express or implied warranty, relating to sale and/or use of Microsemi products including liability or warranties relating to fitness for a particular purpose, merchantability, or infringement of any patent, copyright or other intellectual property right. Any performance specifications believed to be reliable but are not verified and customer or user must conduct and complete all performance and other testing of this product as well as any user or customers final application. User or customer shall not rely on any data and performance specifications or parameters provided by Microsemi. It is the customer's and user's responsibility to independently determine suitability of any Microsemi product and to test and verify the same. The information contained herein is provided "AS IS, WHERE IS" and with all faults, and the entire risk associated with such information is entirely with the User. Microsemi specifically disclaims any liability of any kind including for consequential, incidental and punitive damages as well as lost profit. The product is subject to other terms and conditions which can be located on the web at <http://www.microsemi.com/legal/tnc.asp>

Life Support Application

Seller's Products are not designed, intended, or authorized for use as components in systems intended for space, aviation, surgical implant into the body, in other applications intended to support or sustain life, or for any other application in which the failure of the Seller's Product could create a situation where personal injury, death or property damage or loss may occur (collectively "Life Support Applications").

Buyer agrees not to use Products in any Life Support Applications and to the extent it does it shall conduct extensive testing of the Product in such applications and further agrees to indemnify and hold Seller, and its officers, employees, subsidiaries, affiliates, agents, sales representatives and distributors harmless against all claims, costs, damages and expenses, and attorneys' fees and costs arising, directly or indirectly, out of any claims of personal injury, death, damage or otherwise associated with the use of the goods in Life Support Applications, even if such claim includes allegations that Seller was negligent regarding the design or manufacture of the goods.

Buyer must notify Seller in writing before using Seller's Products in Life Support Applications. Seller will study with Buyer alternative solutions to meet Buyer application specification based on Sellers sales conditions applicable for the new proposed specific part.