



S10317 series S11257 series

Low voltage operation (3.3 V)

The S10317/S11257 series photo IC use a high-speed PIN photodiode designed for laser beam synchronous detection. They operate at a low voltage (3.3 V) compatible with low-voltage peripheral components mounted on the same PC board. Two types of current amplifiers are available with a gain of 6 times (S10317-01, S11257-01DT) and 20 times (S10317, S11257-02DT) that can be selected according to laser power to be used. HAMAMATSU also provides a 5 V operation type (S9703 series) and dual-element Si PIN photodiode types (S9684 series, S11282-01DS).

Features

- Low voltage operation (3.3 V)
- High sensitivity
Current amplifier gain: 20 times (S10317, S11257-02DT)
6 times (S10317-01, S11257-01DT)
- Digital output
- Small package
- Suitable for lead-free solder reflow
- photosensitive area: 2.84 × 0.5 mm (S10317 series)
2.84 × 0.25 mm (S11257 series)

Applications

- Print start timing detection for laser printers, digital copiers, fax machines, etc.

Absolute maximum ratings

Parameter	Symbol	Condition	Value	Unit
Supply voltage	Vcc	Ta=25 °C	-0.5 to +7	V
Power dissipation*1	P	Ta=25 °C	300	mW
Output voltage*2	Vo	Ta=25 °C	-0.5 to +7	V
Output current	Io	Ta=25 °C	5	mA
Ro terminal current	IRO	Ta=25 °C	3	mA
Operating temperature	Topr		-25 to +80	°C
Storage temperature	Tstg		-40 to +85	°C
Reflow soldering conditions*3	Tsol		Peak temperature 240 °C max., 1 time	-

*1: Power dissipation decreases at a rate of 4 mW/°C above Ta=25 °C.

*2: Vcc=+0.5 V or less

*3: JEDEC level 5a

Note: Exceeding the absolute maximum ratings even momentarily may cause a drop in product quality. Always be sure to use the product within the absolute maximum ratings.

Electrical and optical characteristics

($T_a=25\text{ }^\circ\text{C}$, $\lambda=780\text{ nm}$, $V_{cc}=3.3\text{ V}$, $R_o=5.1\text{ k}\Omega$, light incident angle=normal line direction $\pm 0^\circ$, unless otherwise noted)

Parameter	Symbol	Condition	Min.	Typ.	Max.	Unit
Recommended operation voltage	S10317 series		3.13	3.3	3.6	V
	S11257 series		3.135	3.3	3.45	
Current consumption	I_{cc}	No input	-	0.7	1.5	mA
High level output voltage	V_{OH}	$I_{OH}=4\text{ mA}$	2.9	-	-	V
Low level output voltage	V_{OL}	$I_{OL}=4\text{ mA}^{*4}$	-	-	0.3	V
Threshold input power	S10317, S11257-02DT	P_{TH}	14	19	24	μW
	S10317-01, S11257-01DT		49.5	62	74.5	
H→L propagation delay time	S10317, S11257-02DT	t_{PHL}	-	130	250	ns
	S10317-01, S11257-01DT		-	100	200	
L→H propagation delay time	S10317, S11257-02DT	t_{PLH}	-	200	300	ns
	S10317-01, S11257-01DT		-	150	250	
Rise time	t_r	Duty ratio 1:1	-	4	7	ns
Fall time	t_f	$C_L=15\text{ pF}^{*5}$	-	4	7	ns
Maximum input power	$P_I\text{ max.}$		-	-	$P_{TH} \times 8$	μW

*4: Input power $P_I=57\text{ }\mu\text{W}$ (S10317, S11257-02DT), $186\text{ }\mu\text{W}$ (S10317-01, S11257-01DT)

*5: Measured with a pulse-driven laser diode. Input light-pulse rise time and fall times are 1 ns or less.

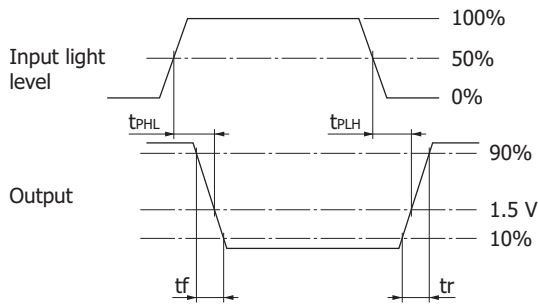

KPIC00112EA

Spectral response

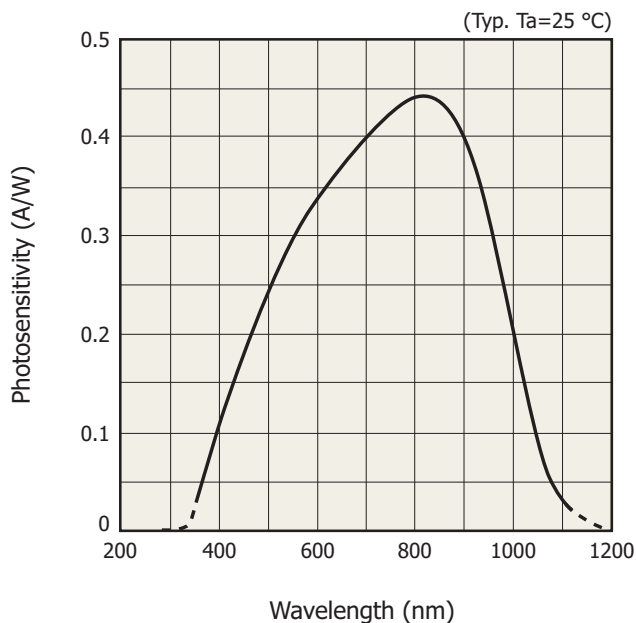

KPICB0166EA

Block diagram

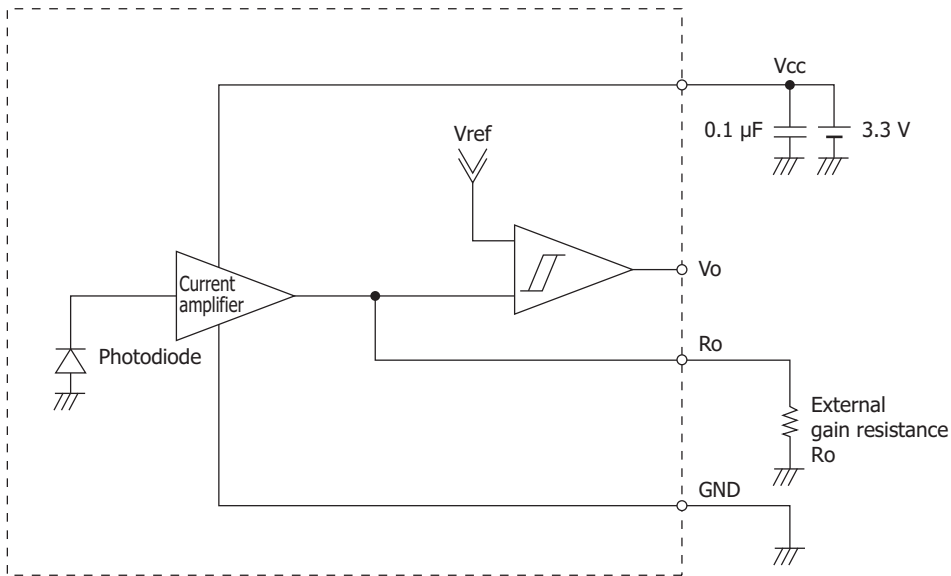

KPIC00127EA

Function

These products integrate a photodiode chip and an IC chip into the same package. The photodiode chip is internally connected to the IC chip as shown in the block diagram. The products should be used with terminal R_o connected to an external gain resistance R_o .

A photocurrent is generated when a laser beam enters the photodiode. This photocurrent is fed to the input terminal of the IC and, after being amplified by the current amplifier, flows to the external gain resistance. At this time, voltages V_{RO} at terminal R_o is given by the following expression.

$$V_{RO} = A \times S \times P_i \times R_o \quad [V] \quad \dots\dots\dots (1)$$

A: Current amplifier gain (S10317, S11257-02DT: 20 times, S10317-01, S11257-01DT: 6 times)

S: Photodiode sensitivity [A/W] (approx. 0.44 A/W at 780 nm)

P_i : Input power [W]

R_o : External gain resistance [Ω]; usable range 2 k Ω to 10 k Ω

V_{RO} is input to the internal comparator and compared with the internal reference voltage V_{ref} (approx. 0.8 V) so the output V_o is "High" when $V_{RO} < V_{ref}$ or "Low" when $V_{RO} > V_{ref}$.

We recommend that V_{RO} be set higher than 1.5 V but lower than 8 times of V_{RO} calculated from equation (1) where P_1 is the threshold input power.

Also set the R_o resistance so that the R_o terminal current does not exceed the absolute maximum rating of 3 mA.

(Monitoring V_{RO} shows that it is limited to about 2 V (with respect to GND) by the voltage limiting circuit. Keep this in mind when monitoring.)

Dimensional outline (unit: mm)

S10317 series

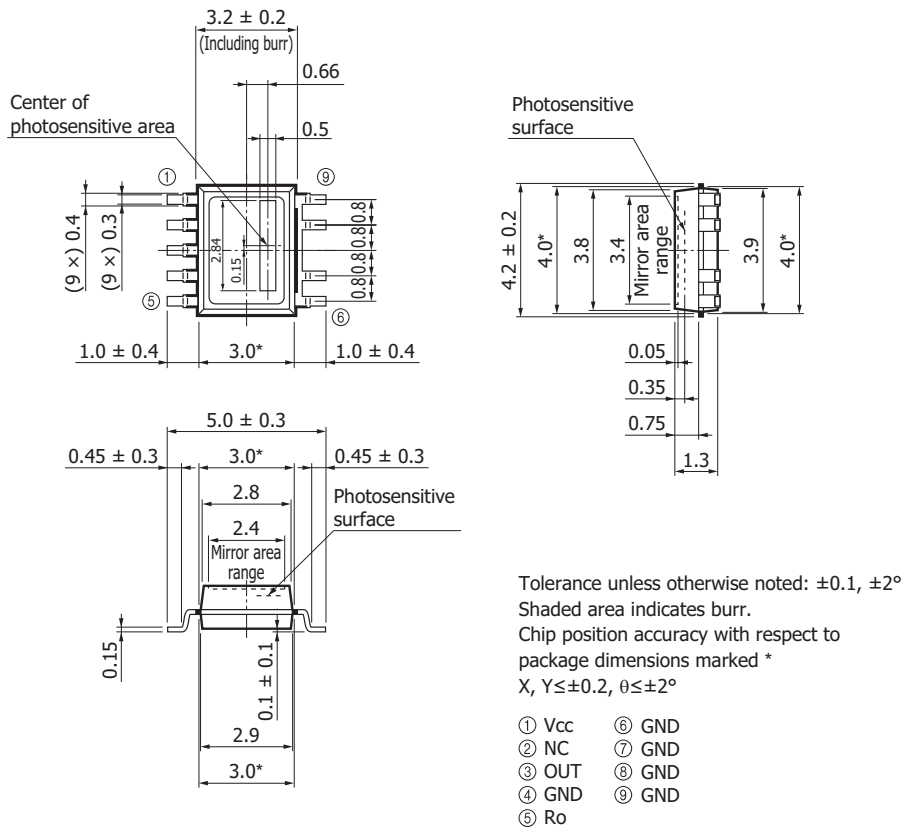

KPICA0070ED

S11257 series

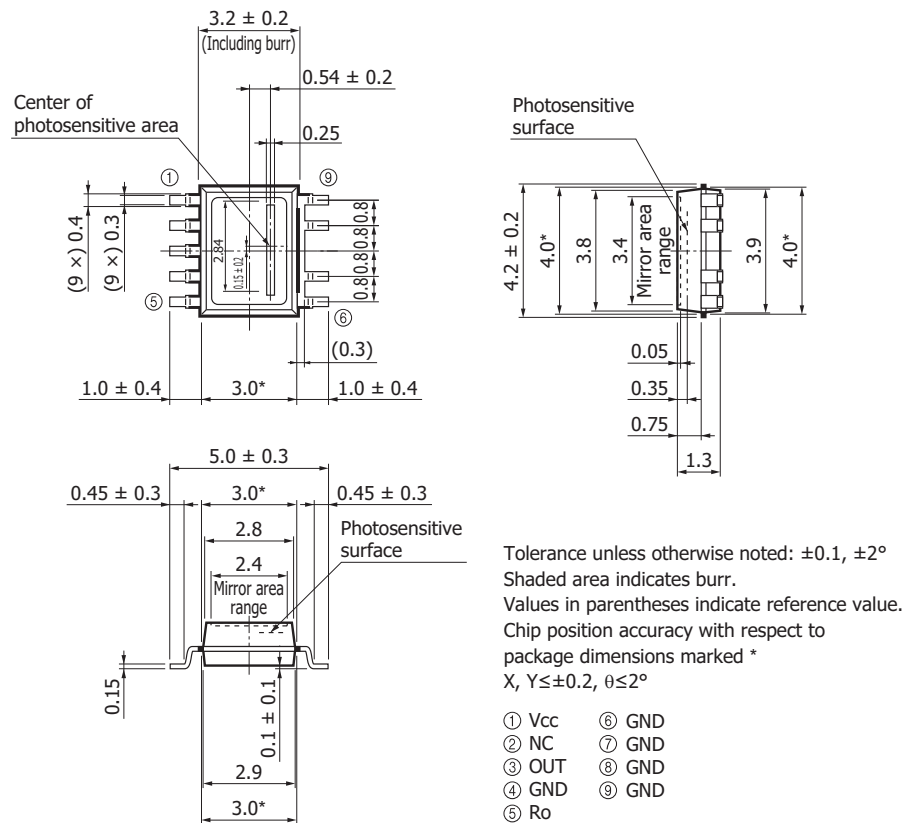

KPICA0089EB

■ Recommended land pattern (unit: mm)

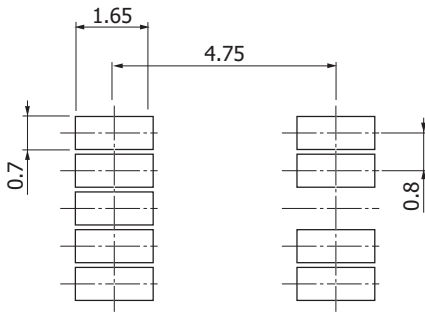

KPICB0224EA

■ Standard packing specifications

■ Reel (conforms to JEITA ET-7200)

Dimensions	Hub diameter	Tape width	Material	Electrostatic characteristics
254 mm	100 mm	12 mm	PS	Antistatic treatment

■ Embossed tape (unit: mm, material: PS, conductive)

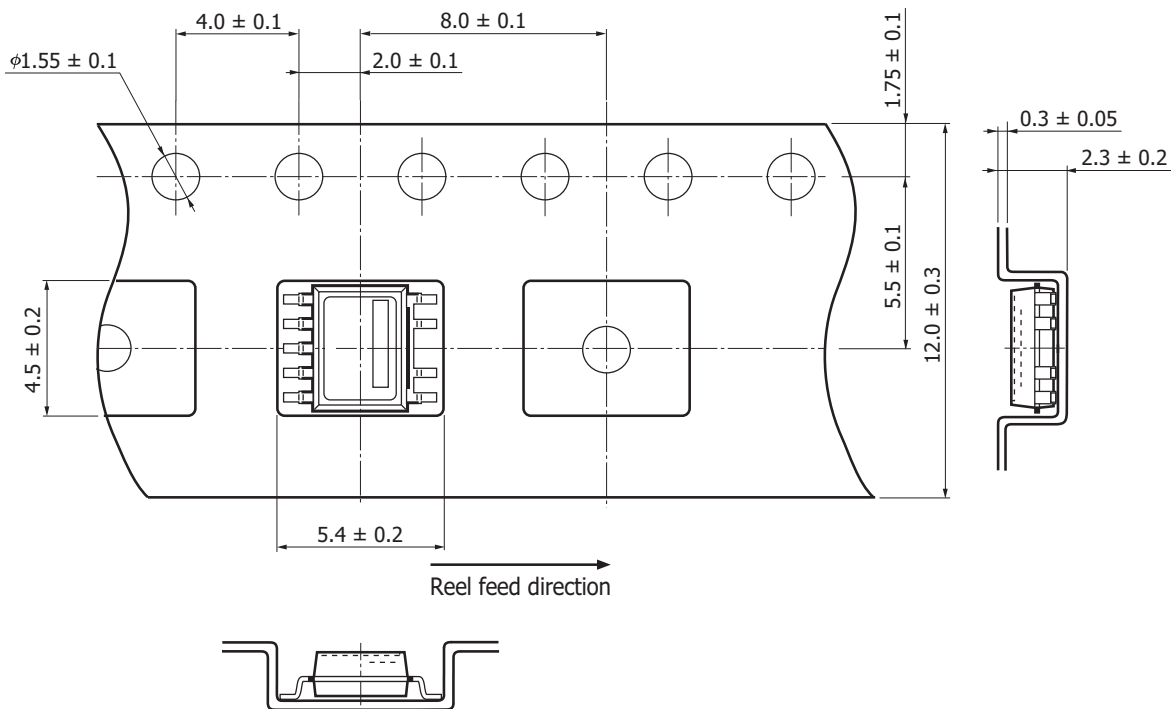

KPIC0225EA

■ Packing quantity
2000 pcs/reel

■ Packing type
Reel and desiccant in moisture-proof packaging (vacuum-sealed)

Measured example of temperature profile with our hot-air reflow oven for product testing

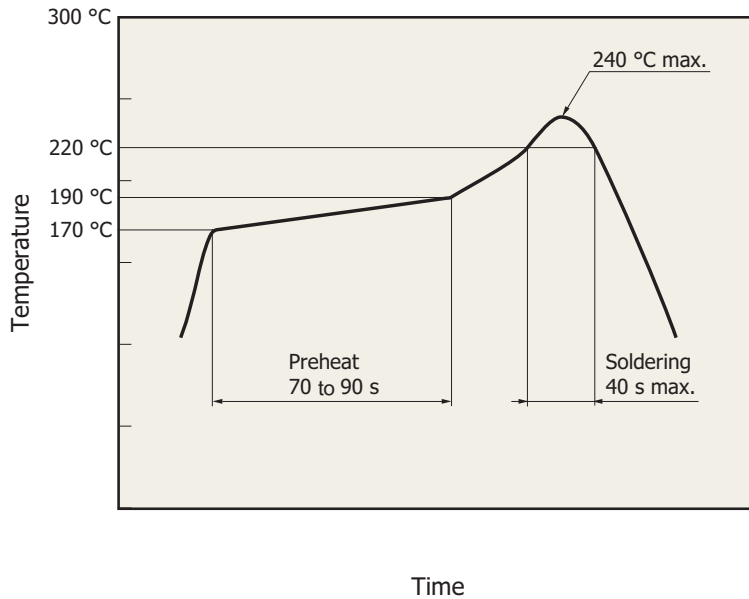

KPICB0164EC

- This product supports lead-free soldering. After unpacking, store it in an environment at a temperature of 30 °C or less and a humidity of 60% or less, and perform soldering within 24 hours.
- The effect that the product receives during reflow soldering varies depending on the circuit board and reflow oven that are used. Before actual reflow soldering, check for any problems by testing out the reflow soldering methods in advance.

Related information

www.hamamatsu.com/sp/ssd/doc_en.html

■ Precautions

- Notice
- Surface mount type products / Precautions

Information described in this material is current as of December, 2013.

Product specifications are subject to change without prior notice due to improvements or other reasons. This document has been carefully prepared and the information contained is believed to be accurate. In rare cases, however, there may be inaccuracies such as text errors. Before using these products, always contact us for the delivery specification sheet to check the latest specifications.

The product warranty is valid for one year after delivery and is limited to product repair or replacement for defects discovered and reported to us within that one year period. However, even if within the warranty period we accept absolutely no liability for any loss caused by natural disasters or improper product use.

Copying or reprinting the contents described in this material in whole or in part is prohibited without our prior permission.

HAMAMATSU

www.hamamatsu.com

HAMAMATSU PHOTONICS K.K., Solid State Division

1126-1 Ichino-cho, Higashi-ku, Hamamatsu City, 435-8558 Japan, Telephone: (81) 53-434-3311, Fax: (81) 53-434-5184

U.S.A.: Hamamatsu Corporation: 360 Foothill Road, P.O.Box 6910, Bridgewater, N.J. 08807-0910, U.S.A., Telephone: (1) 908-231-0960, Fax: (1) 908-231-1218

Germany: Hamamatsu Photonics Deutschland GmbH: Arzbergerstr. 10, D-82211 Herrsching am Ammersee, Germany, Telephone: (49) 8152-375-0, Fax: (49) 8152-265-8

France: Hamamatsu Photonics France S.A.R.L.: 19, Rue du Saule Trapu, Parc du Moulin de Massy, 91882 Massy Cedex, France, Telephone: 33-(1) 69 53 71 00, Fax: 33-(1) 69 53 71 10

United Kingdom: Hamamatsu Photonics UK Limited: 2 Howard Court, 10 Tewin Road, Welwyn Garden City, Hertfordshire AL7 1BW, United Kingdom, Telephone: (44) 1707-294888, Fax: (44) 1707-325777

North Europe: Hamamatsu Photonics Norden AB: Thorshamnsgatan 35 16440 Kista, Sweden, Telephone: (46) 8-509-031-00, Fax: (46) 8-509-031-01

Italy: Hamamatsu Photonics Italia S.R.L.: Strada della Moia, 1 int. 6, 20020 Arese, (Milano), Italy, Telephone: (39) 02-935-81-733, Fax: (39) 02-935-81-741

China: Hamamatsu Photonics (China) Co., Ltd.: 1201 Tower B, Jiaming Center, No.27 Dongsanhuan Beilu, Chaoyang District, Beijing 100020, China, Telephone: (86) 10-6586-6006, Fax: (86) 10-6586-2866