

Thermally-Enhanced High Power RF LDMOS FET 320 W, 28 V, 2110 – 2170 MHz

Description

The PTFB213208SV is a 320-watt LDMOS FET intended for use in multi-standard cellular power amplifier applications in the 2110 to 2170 MHz frequency band. Features include input and output matching, high gain and thermally-enhanced package with earless flange. Manufactured with Infineon's advanced LDMOS process, this device provides excellent thermal performance and superior reliability.

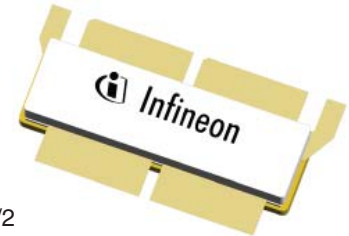

PTFB213208FV
Package H-34275G-6/2

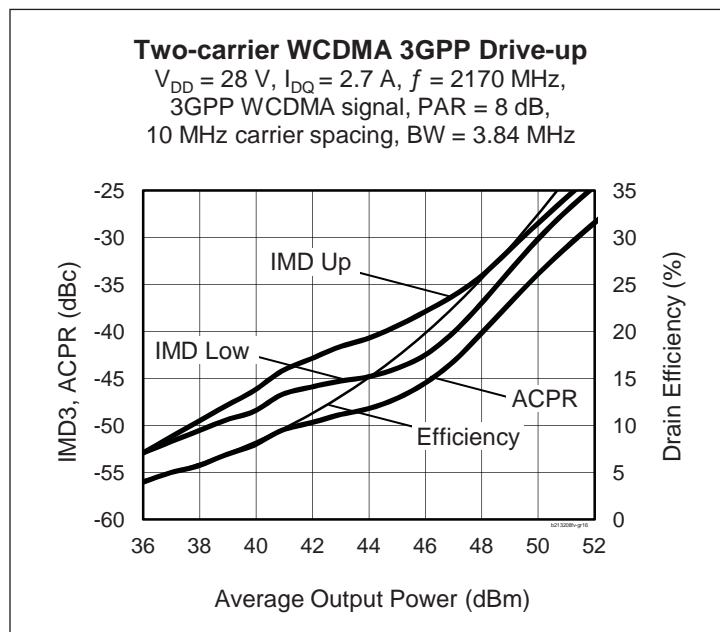

Features

- Broadband internal matching
- Wide video bandwidth
- Typical pulsed CW performance, 2140 MHz, 28 V (combined outputs)
 - Output power @ $P_{1dB} = 343\text{ W}$
 - Efficiency = 54%
 - Gain = 16.5 dB
- Typical single-carrier WCDMA performance, 2140 MHz, 28 V
 - Output power = 50 dBm avg
 - Gain = 17 dB
 - Efficiency = 32%
- Capable of handling 10:1 VSWR @ 28 V, 320 W (CW) output power
- Integrated ESD protection
- Low thermal resistance
- Pb-free and RoHS compliant

RF Characteristics

Single-carrier WCDMA Measurements (tested in Infineon test fixture)

$V_{DD} = 28\text{ V}$, $I_{DQ} = 2.6\text{ A}$, $P_{OUT} = 85\text{ W}$ average, $f = 2170\text{ MHz}$
 3GPP WCDMA signal, 3.84 MHz channel bandwidth, peak/average = 10 dB @ 0.01% CCDF

Characteristic	Symbol	Min	Typ	Max	Unit
Gain	Gps	15.75	17.0	—	dB
Drain Efficiency	η_D	—	32	—	%
Adjacent Channel Power Ratio	ACPR	—	-35	-29.5	dBc

All published data at $T_{CASE} = 25^\circ\text{C}$ unless otherwise indicated

ESD: Electrostatic discharge sensitive device—observe handling precautions!

DC Characteristics (both sides)

Characteristic	Conditions	Symbol	Min	Typ	Max	Unit
Drain-Source Breakdown Voltage	$V_{GS} = 0\text{ V}$, $I_{DS} = 10\text{ mA}$	$V_{(BR)DSS}$	65	—	—	V
Drain Leakage Current	$V_{DS} = 28\text{ V}$, $V_{GS} = 0\text{ V}$	I_{DSS}	—	—	1.0	μA
	$V_{DS} = 63\text{ V}$, $V_{GS} = 0\text{ V}$	I_{DSS}	—	—	10.0	μA
On-State Resistance	$V_{GS} = 10\text{ V}$, $V_{DS} = 0.1\text{ V}$	$R_{DS(on)}$	—	0.05	—	Ω
Operating Gate Voltage	$V_{DS} = 28\text{ V}$, $I_{DQ} = 2.6\text{ A}$	V_{GS}	2.3	2.8	3.3	V
Gate Leakage Current	$V_{GS} = 10\text{ V}$, $V_{DS} = 0\text{ V}$	I_{GSS}	—	—	1.0	μA

Maximum Ratings

Parameter	Symbol	Value	Unit
Drain-Source Voltage	V_{DSS}	65	V
Gate-Source Voltage	V_{GS}	-6 to +10	V
Junction Temperature	T_J	200	$^{\circ}\text{C}$
Storage Temperature Range	T_{STG}	-40 to +150	$^{\circ}\text{C}$
Thermal Resistance ($T_{CASE} = 70^{\circ}\text{C}$, 200 W CW)	$R_{\theta JC}$	0.20	$^{\circ}\text{C/W}$

Ordering Information

Type and Version	Order Code	Package Description	Shipping
PTFB213208FV V1	PTFB213208FVV1XWSA1	H-34275G-6/2, ceramic open-cavity, push-pull earless	Tray
PTFB213208FV V1 R250	PTFB213208FVV1R250XTMA1	H-34275G-6/2, ceramic open-cavity, push-pull earless	Tape & Reel, 250 pcs

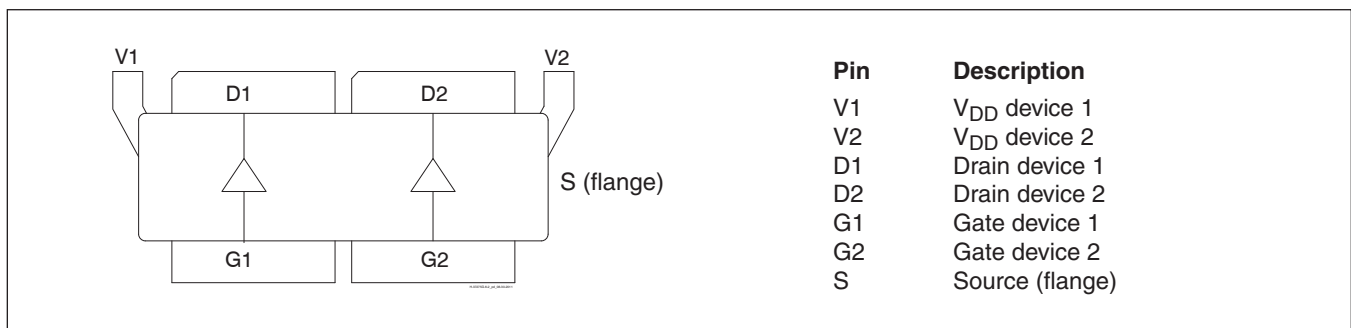
Pinout Diagram (top view)

Lead connections for PTFB213208SV

Typical Performance (data taken in a production test fixture)

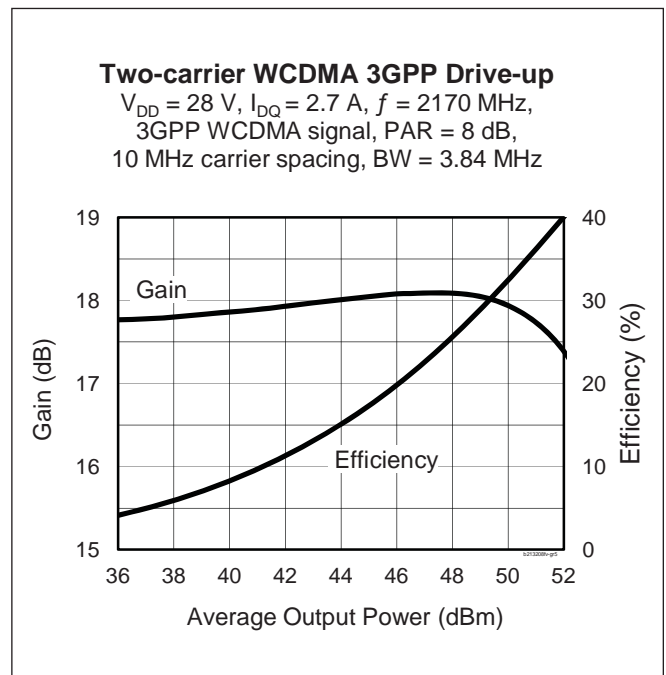
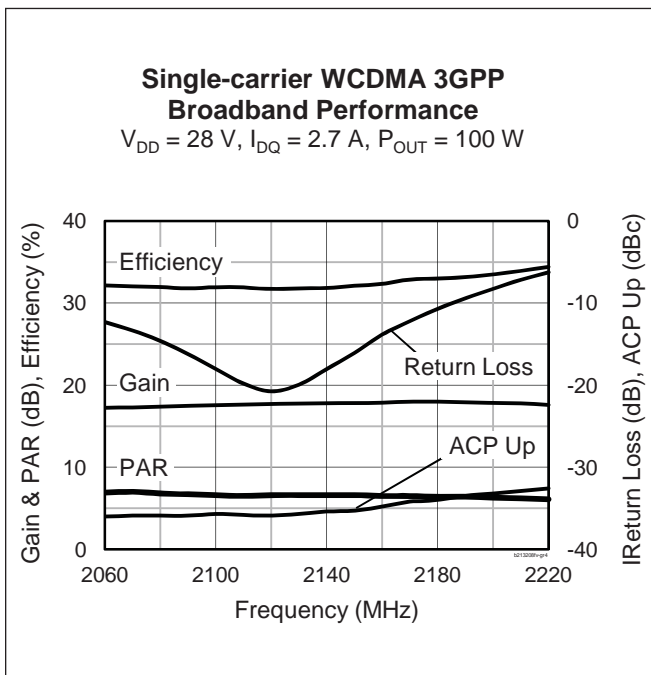
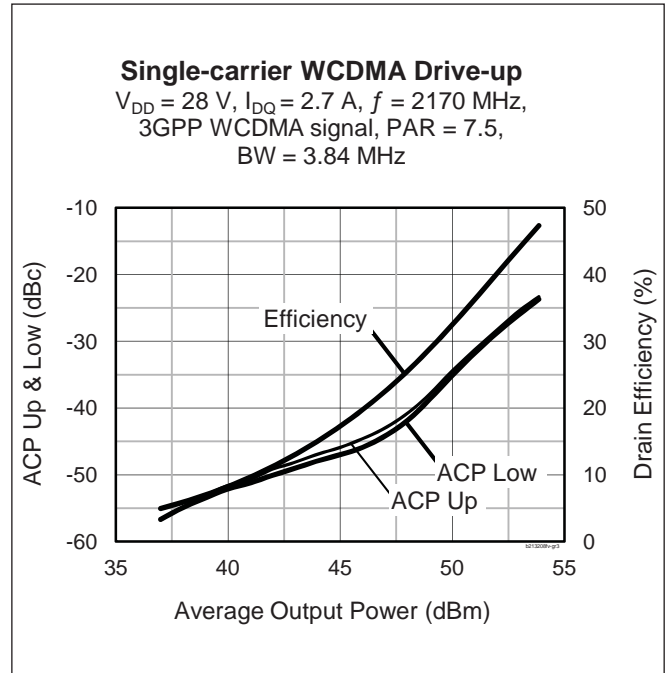
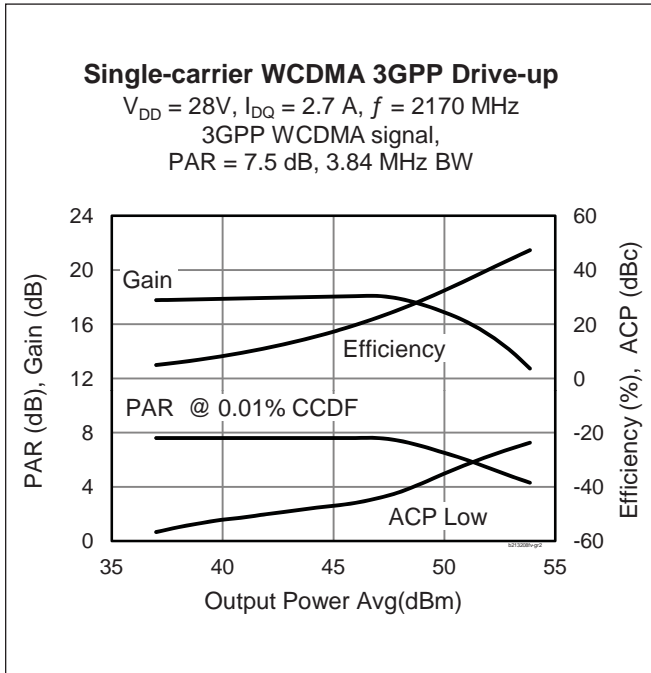

Typical Performance (cont.)

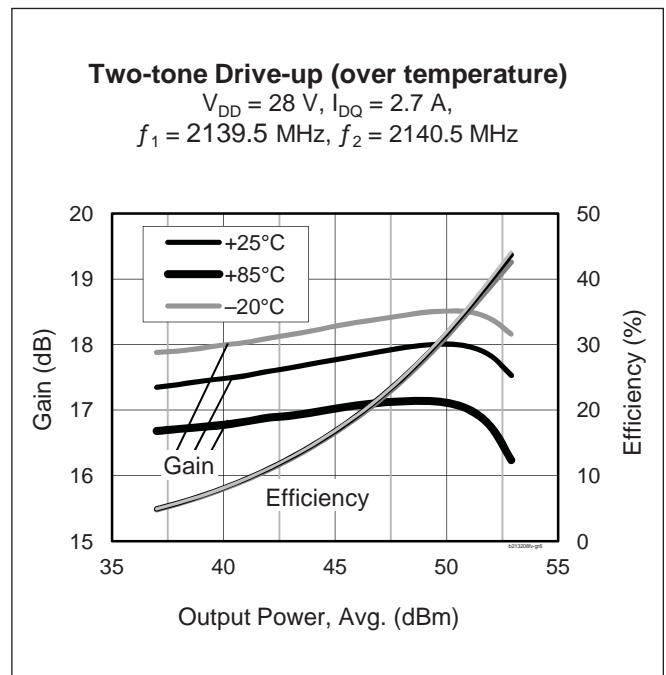
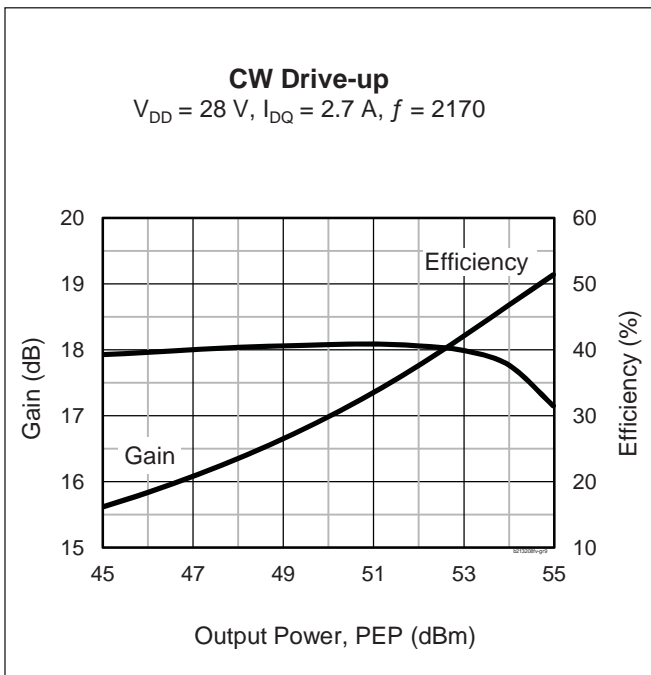
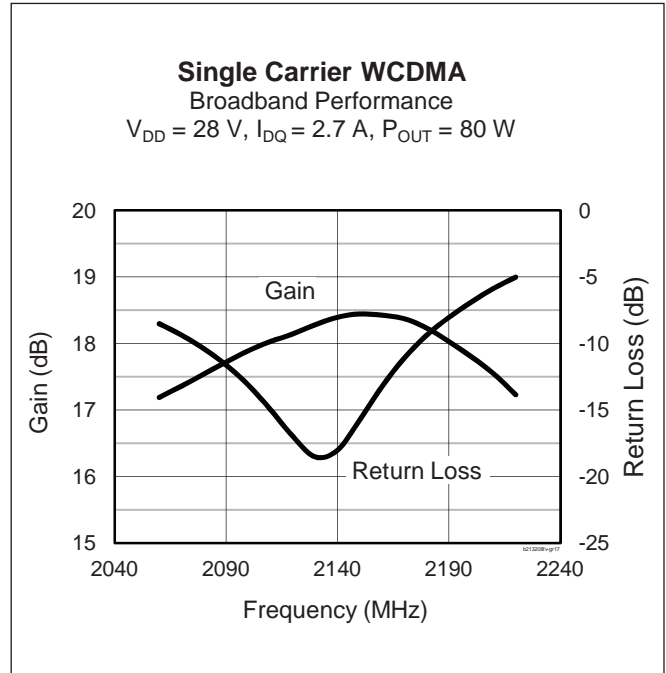
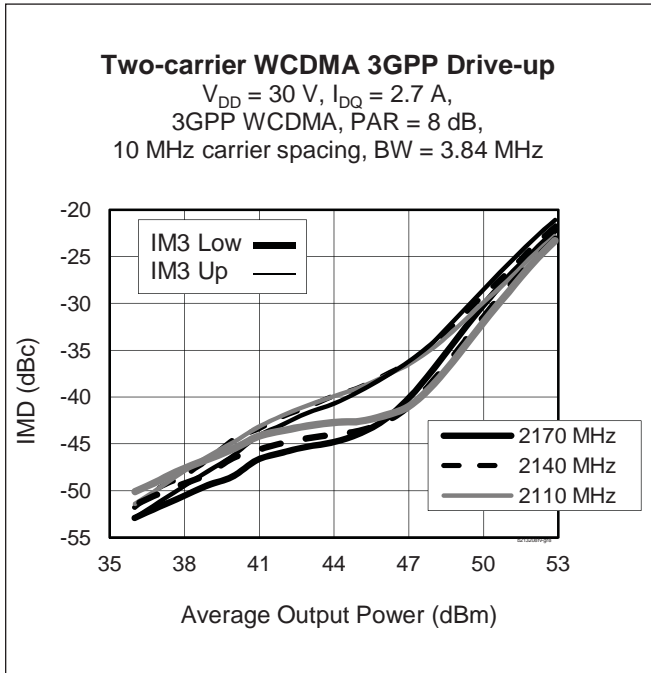

Typical Performance (cont.)

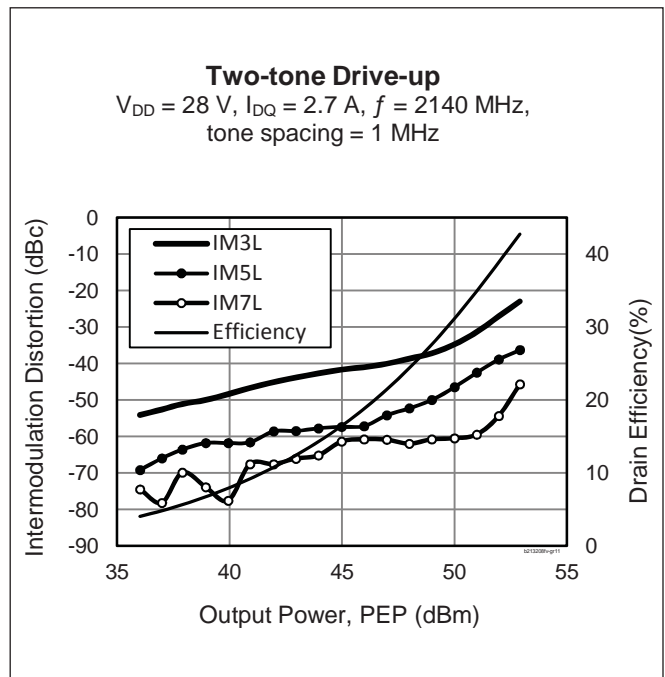
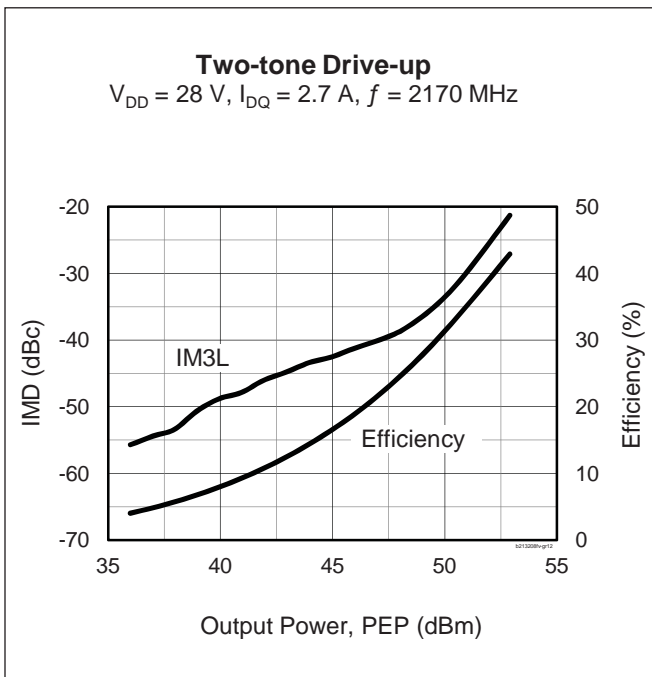
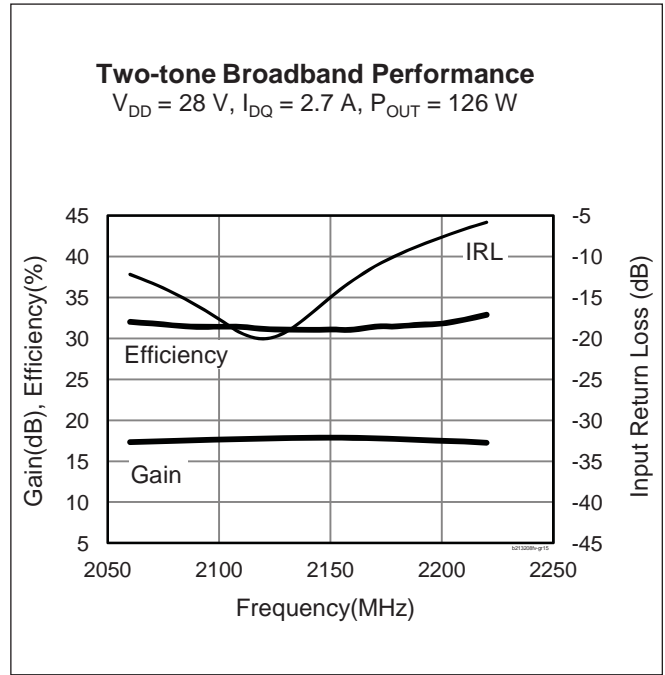
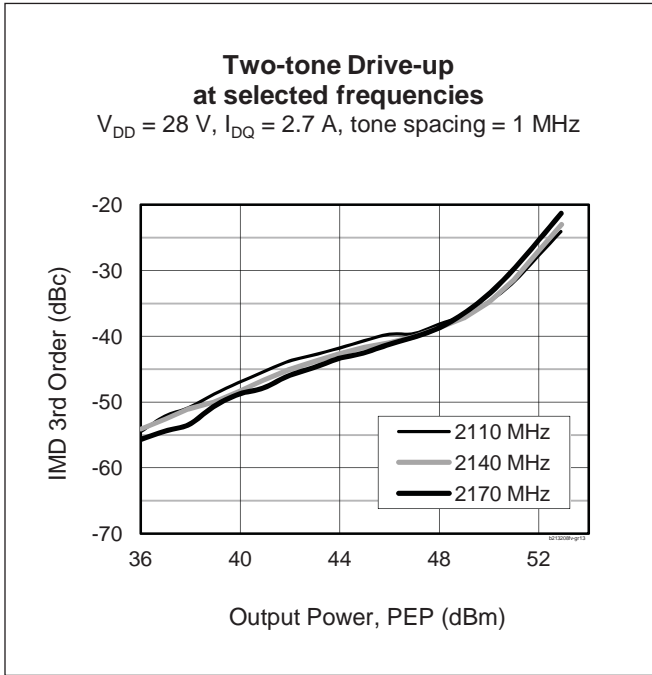

Broadband Circuit Impedance

Frequency MHz	Z Source Ω		Z Load Ω	
	R	jX	R	jX
2100	3.34	-5.60	0.55	-1.99
2110	3.32	-5.61	0.55	-1.96
2120	3.30	-5.62	0.55	-1.94
2130	3.27	-5.63	0.54	-1.92
2140	3.24	-5.64	0.54	-1.89
2150	3.21	-5.65	0.54	-1.87
2160	3.18	-5.66	0.54	-1.85
2170	3.15	-5.67	0.54	-1.82
2180	3.11	-5.68	0.54	-1.80
2190	3.07	-5.69	0.54	-1.78
2200	3.03	-5.70	0.54	-1.75

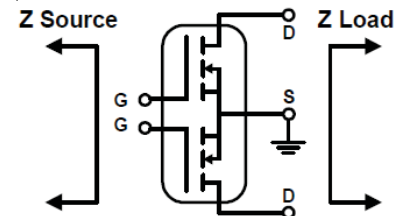

See next page for reference circuit information

Reference Circuit

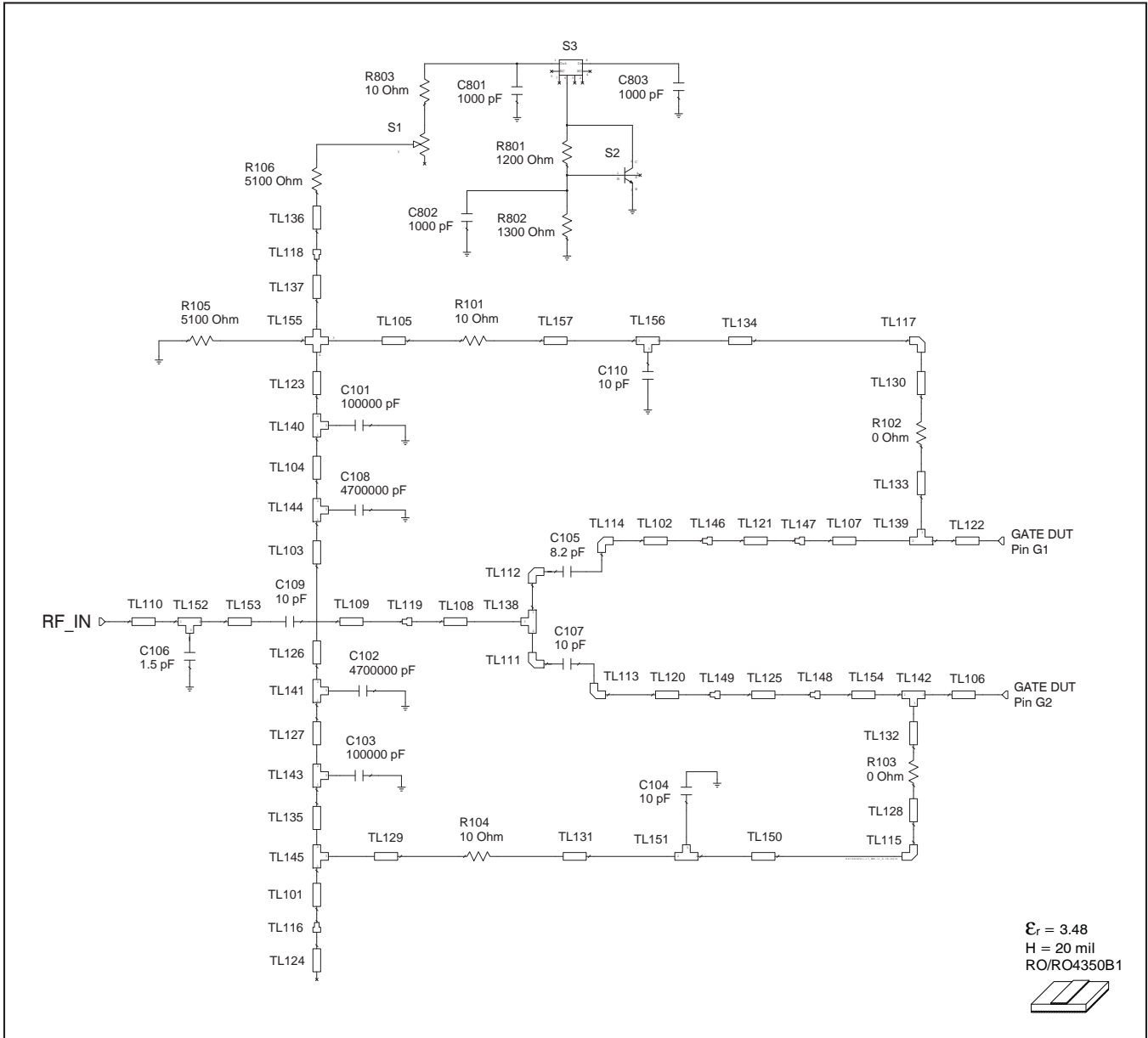

Reference circuit input schematic for $f = 2170 \text{ MHz}$

Reference Circuit (cont.)

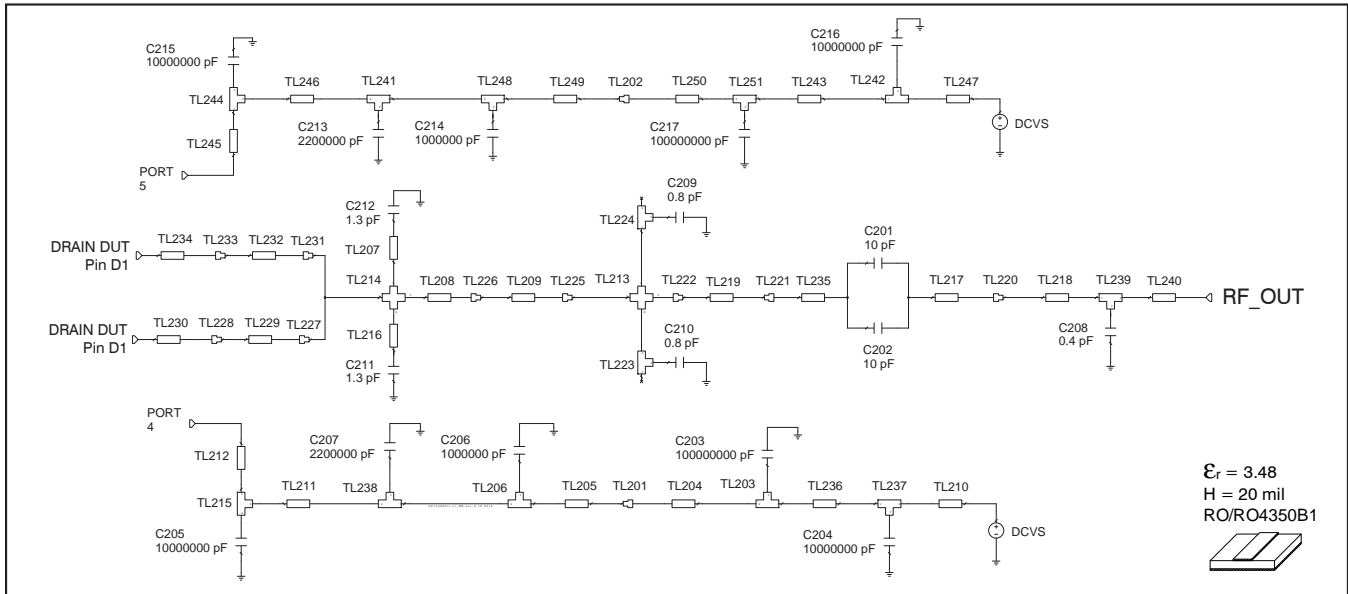

Reference circuit output schematic for $f = 2170$ MHz

Reference Circuit Assembly

DUT	PTFB213208FV
Test Fixture Part No.	LTN/PTFB213208FV
PCB	Rogers RO4350, 0.508 mm [0.020"] thick, 2 oz. copper, $\epsilon_r = 3.48$
Find Gerber files for this test fixture on the Infineon Web site at (www.infineon.com/rfpower)	

Electrical Characteristics at 2170 MHz

Transmission Line	Electrical Characteristics	Dimensions: mm	Dimensions: mils
Input			
TL101	0.006λ , 63.89 Ω	W = 0.76, L = 0.51	W = 30, L = 20
TL102, TL120	0.009λ , 28.85 Ω	W = 2.54, L = 0.76	W = 100, L = 30
TL103	0.156λ , 63.89 Ω	W = 0.76, L = 13.19	W = 30, L = 519
TL104	0.010λ , 63.89 Ω	W = 0.76, L = 0.81	W = 30, L = 32
TL105	0.020λ , 54.17 Ω	W = 1.02, L = 1.65	W = 40, L = 65
TL106, TL122	0.070λ , 7.29 Ω	W = 12.7, L = 5.36	W = 500, L = 211
TL107	0.017λ , 7.29 Ω	W = 12.7, L = 1.3	W = 500, L = 51
TL108	0.025λ , 32.6 Ω	W = 2.16, L = 2.03	W = 85, L = 80
TL109	0.060λ , 49.69 Ω	W = 1.17, L = 5.02	W = 46, L = 197
TL110	0.006λ , 49.69 Ω	W = 1.17, L = 0.51	W = 46, L = 20
TL121	0.023λ , 17.05 Ω	W = 4.88, L = 1.78	W = 192, L = 70
TL123	0.054λ , 63.89 Ω	W = 0.76, L = 4.57	W = 30, L = 180
TL124	0.016λ , 34.08 Ω	W = 2.03, L = 1.27	W = 80, L = 50
TL125	0.023λ , 17.05 Ω	W = 4.88, L = 1.78	W = 192, L = 70

table continued on next page

Reference Circuit (cont.)

Electrical Characteristics at 2170 MHz (Input cont.)

Transmission Line	Electrical Characteristics	Dimensions: mm	Dimensions: mils
TL126	0.018 λ , 63.89 Ω	W = 0.76, L = 1.52	W = 30, L = 6
TL126	0.018 λ , 63.89 Ω	W = 0.76, L = 1.52	W = 30, L = 60
TL127	0.011 λ , 63.89 Ω	W = 0.76, L = 0.89	W = 30, L = 35
TL128, TL130	0.006 λ , 54.17 Ω	W = 1.02, L = 0.51	W = 40, L = 20
TL129	0.018 λ , 54.17 Ω	W = 1.02, L = 1.53	W = 40, L = 60
TL131	0.017 λ , 54.17 Ω	W = 1.02, L = 1.42	W = 40, L = 56
TL132, TL133	0.009 λ , 54.17 Ω	W = 1.02, L = 0.76	W = 40, L = 30
TL134	0.098 λ , 54.17 Ω	W = 1.02, L = 8.2	W = 40, L = 323
TL135	0.056 λ , 63.89 Ω	W = 0.76, L = 4.72	W = 30, L = 186
TL136	0.016 λ , 34.08 Ω	W = 2.03, L = 1.27	W = 80, L = 50
TL137	0.003 λ , 63.89 Ω	W = 0.76, L = 0.28	W = 30, L = 10
TL138	0.027 λ , 28.85 Ω	W1 = 2.54, W2 = 2.54, W3 = 2.16	W1 = 100, W2 = 100, W3 = 85
TL139, TL142	0.013 λ , 7.29 Ω	W1 = 12.7, W2 = 12.7, W3 = 1.02	W1 = 500, W2 = 500, W3 = 40
TL140, TL141, TL143, TL144	0.015 λ , 63.89 Ω	W1 = 0.76, W2 = 0.76, W3 = 1.27	W1 = 30, W2 = 30, W3 = 50
TL145	0.012 λ , 63.89 Ω	W1 = 0.76, W2 = 0.76, W3 = 1.02	W1 = 30, W2 = 30, W3 = 40
TL150	0.100 λ , 54.17 Ω	W = 1.02, L = 8.36	W = 40, L = 329
TL151, TL156	0.015 λ , 54.17 Ω	W1 = 1.02, W2 = 1.02, W3 = 1.27	W1 = 40, W2 = 40, W3 = 50
TL152	0.015 λ , 49.69 Ω	W1 = 1.17, W2 = 1.17, W3 = 1.27	W1 = 46, W2 = 46, W3 = 50
TL153	0.012 λ , 49.69 Ω	W = 1.17, L = 0.97	W = 46, L = 38
TL154	0.017 λ , 7.29 Ω	W = 12.7, L = 1.3	W = 500, L = 51
TL155	0.090 λ , 47.12 Ω	W1 = 1.27, W2 = 0.767, W3 = 1.27, W4 = 0.72	W1 = 50, W2 = 30, W3 = 50, W4 = 30
TL157	0.017 λ , 54.17 Ω	W = 1.02, L = 1.42	W = 40, L = 56

Output

TL203	0.026 λ , 11.57 Ω	W1 = 7.62, W2 = 7.62, W3 = 2.03	W1 = 300, W2 = 300, W3 = 80
TL204	0.028 λ , 11.57 Ω	W = 7.62, L = 2.18	W = 300, L = 86
TL205	0.089 λ , 20.93 Ω	W = 3.81, L = 7.11	W = 150, L = 280
TL206	0.029 λ , 20.93 Ω	W1 = 3.81, W2 = 3.81, W3 = 2.29	W1 = 150, W2 = 150, W3 = 90
TL207, TL216	0 λ , 144.35 Ω	W = 0.03, L = 0.03	W = 1, L = 1
TL208	0.009 λ , 4.29 Ω	W = 22.35, L = 0.65	W = 880, L = 25
TL209	0.021 λ , 7.92 Ω	W = 11.61, L = 1.6	W = 457, L = 63
TL210	0.013 λ , 11.57 Ω	W = 7.62, L = 1.02	W = 300, L = 40
TL211	0.016 λ , 20.93 Ω	W = 3.81, L = 1.3	W = 150, L = 51
TL212	0.098 λ , 20.93 Ω	W = 3.81, L = 7.8	W = 150, L = 307
TL213	0.003 λ , 10.43 Ω	W1 = 8.56, W2 = 0.25, W3 = 8.56, W4 = 0.25	W1 = 337, W2 = 10, W3 = 337, W4 = 10
TL214	0.020 λ , 4.29 Ω	W1 = 22.35, W2 = 1.52, W3 = 22.35, W4 = 1.52	W1 = 880, W2 = 60, W3 = 880, W4 = 60
TL215	0.048 λ , 20.93 Ω	W1 = 3.81, W2 = 3.81, W3 = 3.81	W1 = 150, W2 = 150, W3 = 150
TL217	0.016 λ , 20.93 Ω	W = 3.81, L = 1.27	W = 150, L = 50

table continued on next page

Reference Circuit (cont.)

Electrical Characteristics at 2170 MHz (Output cont.)

Transmission Line	Electrical Characteristics	Dimensions: mm	Dimensions: mils
TL218	0.033 λ , 47.12 Ω	W = 1.27, L = 2.74	W = 50, L = 108
TL219	0.035 λ , 34.72 Ω	W = 1.98, L = 2.84	W = 78, L = 112
TL223, TL224	0.017 λ , 102.05 Ω	W1 = 0.25, W2 = 0.25, W3 = 1.52	W1 = 10, W2 = 10, W3 = 60
TL229	0.008 λ , 8.64 Ω	W = 10.54, L = 0.65	W = 415, L = 25
TL230, TL234	0.063 λ , 7.29 Ω	W = 12.7, L = 4.8	W = 500, L = 189
TL232	0.008 λ , 8.64 Ω	W = 10.54, L = 0.65	W = 415, L = 25
TL235	0.016 λ , 20.93 Ω	W = 3.81, L = 1.27	W = 150, L = 50
TL236, TL243	0.012 λ , 11.57 Ω	W = 7.62, L = 0.94	W = 300, L = 37
TL237, TL242, TL251	0.026 λ , 11.57 Ω	W1 = 7.62, W2 = 7.62, W3 = 2.03	W1 = 300, W2 = 300, W3 = 80
TL238	0.029 λ , 20.93 Ω	W1 = 3.81, W2 = 3.81, W3 = 2.29	W1 = 150, W2 = 150, W3 = 90
TL239	0.018 λ , 47.12 Ω	W1 = 1.27, W2 = 1.27, W3 = 1.52	W1 = 50, W2 = 50, W3 = 60
TL240	0.054 λ , 47.12 Ω	W = 1.27, L = 4.5	W = 50, L = 177
TL241	0.029 λ , 20.93 Ω	W1 = 3.81, W2 = 3.81, W3 = 2.29	W1 = 150, W2 = 150, W3 = 90
TL244	0.048 λ , 20.93 Ω	W1 = 3.81, W2 = 3.81, W3 = 3.81	W1 = 150, W2 = 150, W3 = 150
TL245	0.098 λ , 20.93 Ω	W = 3.81, L = 7.8	W = 150, L = 307
TL246	0.016 λ , 20.93 Ω	W = 3.81, L = 1.3	W = 150, L = 51
TL247	0.013 λ , 11.57 Ω	W = 7.62, L = 1.02	W = 300, L = 40
TL248	0.029 λ , 20.93 Ω	W1 = 3.81, W2 = 3.81, W3 = 2.29	W1 = 150, W2 = 150, W3 = 90
TL249	0.089 λ , 20.93 Ω	W = 3.81, L = 7.11	W = 150, L = 280
TL250	0.028 λ , 11.57 Ω	W = 7.62, L = 2.18	W = 300, L = 86

Reference Circuit (cont.)

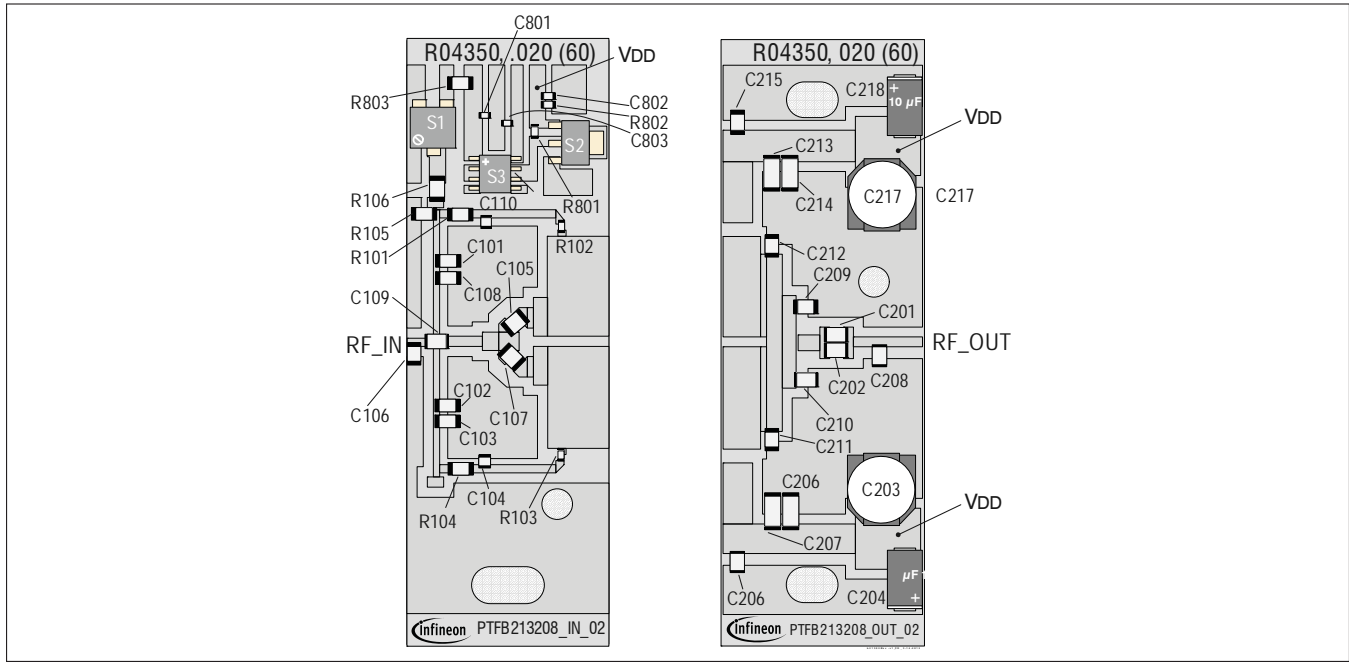

Reference circuit assembly diagram (not to scale)

Component ID	Description	Suggested Supplier	P/N
Input			
C101, C102, C104	Chip capacitor, 300 pF	ATC	ATC100B301KW200X
C103, C108	Chip capacitor, 20 pF	ATC	ATC100B200KW500X
C105	Capacitor, 1 nF	Digi-Key	PCC1772CT-ND
C106	Capacitor, 1 nF	Digi-Key	PCC1772CT-ND
C107	Chip capacitor, 6.2 pF	ATC	ATC100B6R2CT500X
C109	Chip capacitor, 6.2 pF	ATC	ATC100B6R2CT500X
C801, C802, C803	Capacitor, 1000 pF	Digi-Key	PCC1772CT-ND
R101, R102, R103	Resistor, 5.6 Ω	Digi-Key	P5.6ECT-ND
R104, R105, R106	Resistor, 5.6 Ω	Digi-Key	P5.6ECT-ND
R107	Resistor, 1k Ω	Digi-Key	P1.0KECT-ND
Output			
C201	Chip capacitor, 10 pF	ATC	ATC100B100FW500XB
C202	Chip capacitor, 10 pF	ATC	ATC100B100FW500XB
C203	Capacitor, 100 nF	Digi-Key	PCE3718CT-ND
C204, C216	Capacitor, 10 nF	Digi-Key	TPSE106K050R0400
C205	Capacitor, 10 nF	Digi-Key	587-1818-2-ND
C206, C214	Chip capacitor, 1 nF	Digi-Key	445-1411-2-ND
C207, C213	Chip capacitor, 2.2 nF	Digi-Key	445-1447-2-ND
C208	Chip capacitor, 0.4 pF	ATC	ATC100B0R4BW500XB
C209, C210	Chip capacitor, 0.8 pF	ATC	ATC100B0R8BW500XB
C211, C212	Chip capacitor, 1.3 pF	ATC	ATC100B1R3BW500XB
C217	Capacitor, 100 nF	Digi-Key	PCE3718CT-ND

Package Outline Specifications

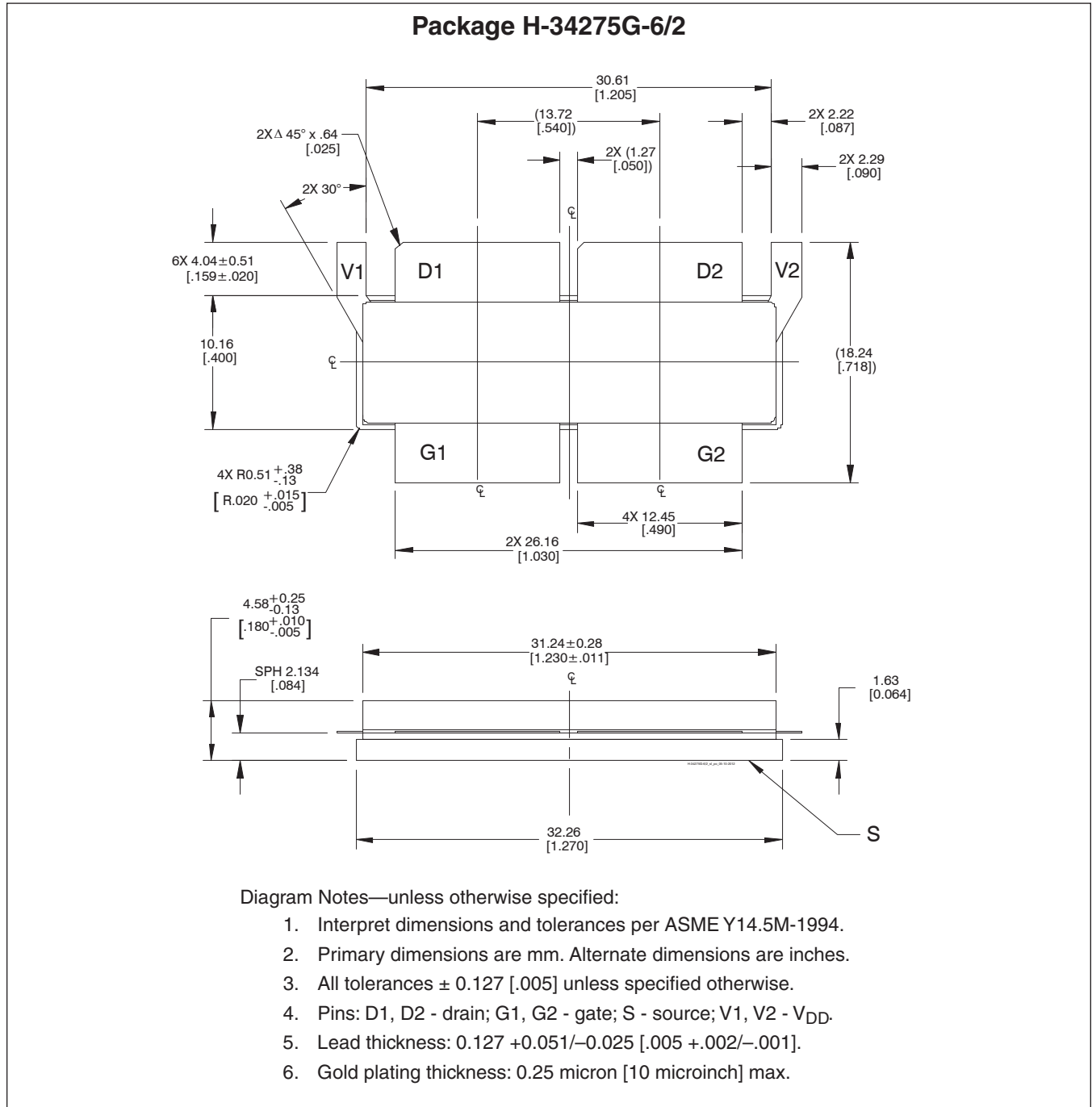

Find the latest and most complete information about products and packaging at the Infineon Internet page (www.infineon.com/rfpower)

Revision History: 2012-07-03**Previous Version:** Advance Specification, 2012-02-07

Page	Subjects (major changes since last revision)
all	Product released: Specifications updated, set; circuit and other information added

We Listen to Your Comments

Any information within this document that you feel is wrong, unclear or missing at all?
 Your feedback will help us to continuously improve the quality of this document.
 Please send your proposal (including a reference to this document) to:

(highpowerRF@infineon.com)

To request other information, contact us at:
 +1 877 465 3667 (1-877-GO-LDMOS) USA
 or +1 408 776 0600 International

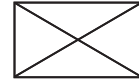
**Edition 2012-07-03**

Published by
Infineon Technologies AG
81726 Munich, Germany

© 2011 Infineon Technologies AG
All Rights Reserved.

Legal Disclaimer

The information given in this document shall in no event be regarded as a guarantee of conditions or characteristics. With respect to any examples or hints given herein, any typical values stated herein and/or any information regarding the application of the device, Infineon Technologies hereby disclaims any and all warranties and liabilities of any kind, including without limitation, warranties of non-infringement of intellectual property rights of any third party.

Information

For further information on technology, delivery terms and conditions and prices, please contact the nearest Infineon Technologies Office (www.infineon.com/rfpower).

Warnings

Due to technical requirements, components may contain dangerous substances. For information on the types in question, please contact the nearest Infineon Technologies Office.

Infineon Technologies components may be used in life-support devices or systems only with the express written approval of Infineon Technologies, if a failure of such components can reasonably be expected to cause the failure of that life-support device or system or to affect the safety or effectiveness of that device or system. Life support devices or systems are intended to be implanted in the human body or to support and/or maintain and sustain and/or protect human life. If they fail, it is reasonable to assume that the health of the user or other persons may be endangered.