



# MPA-359THTU0

MPA

POSITION SENSORS

**SICK**  
Sensor Intelligence.



### Ordering information

Type	Part no.
MPA-359THTU0	1059457

Other models and accessories → [www.sick.com/MPA](http://www.sick.com/MPA)



### Detailed technical data

#### Features

<b>Cylinder types with adapter</b>	Round body cylinder Tie rod cylinder T-slot cylinders Festo cylinders DSBC SMC cylinders CP96
<b>Measuring range</b>	359 mm <sup>1)</sup>
<b>Housing length</b>	361 mm
<b>Output function</b>	Analog, IO-Link
<b>Electrical wiring</b>	DC 4-wire
<b>Analog output (voltage)</b>	0 V ... 10 V
<b>Analog output (current)</b>	4 mA ... 20 mA
<b>Teach-in</b>	✓
<b>Enclosure rating</b>	IP65, IP67, IP68 <sup>2)</sup>
<b>IO-Link functions</b>	Standard functions

<sup>1)</sup> , ± 1 mm.

<sup>2)</sup> According to EN 60529.

#### Mechanics/electronics

<b>Supply voltage</b>	15 V DC ... 30 V DC <sup>1)</sup>
-----------------------	-----------------------------------

<sup>1)</sup> Reverse-polarity protected, operation in short-circuit protected network: max. 8 A.

<sup>2)</sup> Without load.

<sup>3)</sup> Power Output, at 24 V.

<sup>4)</sup> Voltage output.

<sup>5)</sup> FSR: Full Scale Range; max. measuring range.

<sup>6)</sup> At 25 ° C, linearity error (maximum deviation) depending on response curve and minimal deviation function.

<sup>7)</sup> At 25 ° C, repeatability magnet movement in one direction.

<sup>8)</sup> Only in standard mode, not in IO-Link mode.

<sup>9)</sup> The analog measured value can deviate under transient conditions.

<sup>10)</sup> Do not bend below 0 ° C.

<b>Power consumption</b>	≤ 35 mA <sup>2)</sup>
<b>Max. load resistance</b>	≤ 500 Ω <sup>3)</sup>
<b>Min. load resistance</b>	≥ 2 kΩ <sup>4)</sup>
<b>Protection class</b>	III
<b>Required magnetic field sensitivity, typ.</b>	2 mT
<b>Resolution, typ.</b>	0.03 % FSR (max. ≥ 0.06 mm) <sup>5)</sup>
<b>Linearity error, typ.</b>	0.5 mm <sup>6)</sup>
<b>Repeat accuracy, typ.</b>	0.06 % FSR (≥ 0.1 mm) <sup>7)</sup>
<b>Sampling rate, typ.</b>	1.15 ms <sup>8)</sup>
<b>IO-Link</b>	✓
<b>Status indicator LED</b>	✓
<b>Reverse polarity protection</b>	✓
<b>Short-circuit protection</b>	✓
<b>Ambient operating temperature</b>	-20 °C ... +70 °C
<b>Shock and vibration resistance</b>	30 g, 11 ms/10 Hz ... 55 Hz, 1 mm
<b>EMC</b>	According to EN 60947-5-2 <sup>9)</sup>
<b>Housing material</b>	Metal, Aluminum, Plastic
<b>Connection type</b>	Cable, 2 m <sup>10)</sup>
<b>Cable material</b>	PUR
<b>Conductor cross-section</b>	0.08 mm <sup>2</sup>
<b>UL File No.</b>	NRKH.E181493

- 1) Reverse-polarity protected, operation in short-circuit protected network: max. 8 A.
- 2) Without load.
- 3) Power Output, at 24 V.
- 4) Voltage output.
- 5) FSR: Full Scale Range; max. measuring range.
- 6) At 25 °C, linearity error (maximum deviation) depending on response curve and minimal deviation function.
- 7) At 25 °C, repeatability magnet movement in one direction.
- 8) Only in standard mode, not in IO-Link mode.
- 9) The analog measured value can deviate under transient conditions.
- 10) Do not bend below 0 °C.

## Classifications

<b>ECI@ss 5.0</b>	27270104
<b>ECI@ss 5.1.4</b>	27270104
<b>ECI@ss 6.0</b>	27270104
<b>ECI@ss 6.2</b>	27270104
<b>ECI@ss 7.0</b>	27270104
<b>ECI@ss 8.0</b>	27270104
<b>ECI@ss 8.1</b>	27270104
<b>ECI@ss 9.0</b>	27270104
<b>ETIM 5.0</b>	EC002544
<b>ETIM 6.0</b>	EC002544

UNSPSC 16.0901

39122230

### Connection diagram

Cd-354

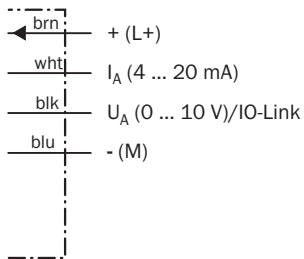

### Dimensional drawing (Dimensions in mm (inch))

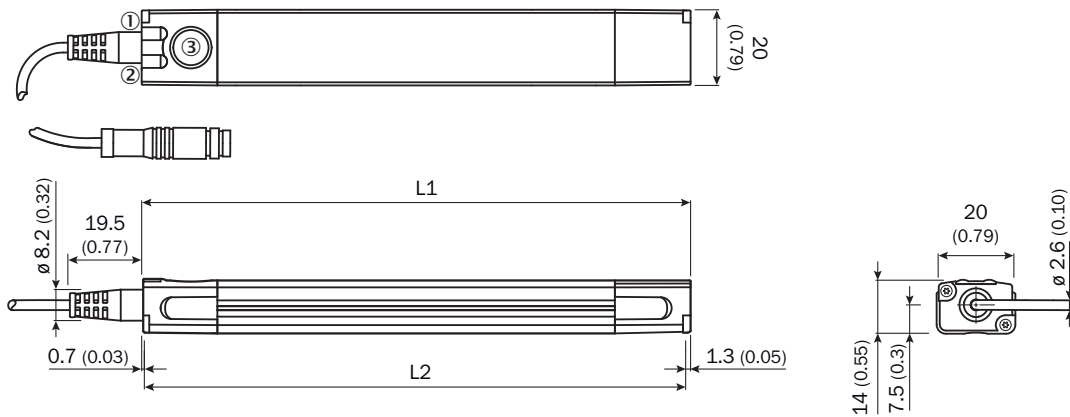









	Total length (L1) mm	Measuring range (L2) mm
<b>MPA-107</b>	109	107
<b>MPA-143</b>	145	143
<b>MPA-179</b>	181	179
<b>MPA-215</b>	217	215
<b>MPA-251</b>	253	251
<b>MPA-287</b>	289	287
<b>MPA-323</b>	325	323
<b>MPA-359</b>	361	359
<b>MPA-395</b>	397	395
<b>MPA-431</b>	433	431
<b>MPA-467</b>	469	467
<b>MPA-503</b>	505	503
<b>MPA-539</b>	541	539

	Total length (L1) mm	Measuring range (L2) mm
<b>MPA-575</b>	577	575
<b>MPA-611</b>	613	611
<b>MPA-647</b>	649	647
<b>MPA-683</b>	685	683
<b>MPA-719</b>	721	719
<b>MPA-755</b>	757	755
<b>MPA-791</b>	793	791
<b>MPA-827</b>	829	827
<b>MPA-863</b>	865	863
<b>MPA-899</b>	901	899
<b>MPA-935</b>	937	935
<b>MPA-971</b>	973	971
<b>MPA-1007</b>	1,009	1,007

- ① Function signal indicator 1
- ② Function signal indicator 2
- ③ Teach-Pad

## Recommended accessories

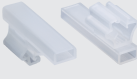
Other models and accessories → [www.sick.com/MPA](http://www.sick.com/MPA)

	Brief description	Type	Part no.
<b>Brackets for cylinder sensors</b>			
	Sensor adapter DSBC-32, Stainless steel V2A	BEF-KHZPF032MPA	2086744
	For tie-rod cylinder (diameter tie-rod max. 18 mm), Aluminum alloy (adapter), Stainless steel V2A (mounting-/fixing screw)	BEF-KHZPZ1MPA	2065578
	For round body cylinders with diameter up to 85 mm, Stainless steel V2A	BEF-KHZR085MPA	2066626
	For round body cylinders with diameter up to 135 mm, Stainless steel V2A	BEF-KHZR135MPA	2066627
	For round body cylinders with diameter up to 210 mm, Stainless steel V2A	BEF-KHZR210MPA	2066628
	Sensor adapter CP96-63, Stainless steel V2A	BEF-KHZTS063MPA	2086756
	Sensor adapter CP96-80, Stainless steel V2A	BEF-KHZTS080MPA	2086757
	Sensor adapter CP96-100, Stainless steel V2A	BEF-KHZTS100MPA	2086758
	Sensor adapter CP96-125, Stainless steel V2A	BEF-KHZTS125MPA	2086759
	For T-slot cylinders, Stainless steel V2A (bracket/mounting screw), Brass (fixing screw/sliding nut)	BEF-KHZT01MPA	2065575
<b>Mounting brackets and plates</b>			
	Bracket for low mounting, Stainless steel V2A (bracket/mounting screw), Brass (fixing screw)	BEF-WNLO1MPA	2065973
	Bracket for lateral mounting, Stainless steel V2A (bracket/mounting screw), Brass (fixing screw)	BEF-WNZO1MPA	2065577
<b>Other mounting accessories</b>			
	10 pieces, Label Holder, 2.5 mm to 3.5 mm, 10 pcs., TPU	LABEL HOLDER	2086019
<b>Magnets</b>			
	Magnet with mounting hole for M3 countersunk screw, Ø 15.2 mm, height 6 mm	Magnet	5327349

## SICK AT A GLANCE

SICK is one of the leading manufacturers of intelligent sensors and sensor solutions for industrial applications. A unique range of products and services creates the perfect basis for controlling processes securely and efficiently, protecting individuals from accidents and preventing damage to the environment.

We have extensive experience in a wide range of industries and understand their processes and requirements. With intelligent sensors, we can deliver exactly what our customers need. In application centers in Europe, Asia and North America, system solutions are tested and optimized in accordance with customer specifications. All this makes us a reliable supplier and development partner.

Comprehensive services complete our offering: SICK LifeTime Services provide support throughout the machine life cycle and ensure safety and productivity.

For us, that is “Sensor Intelligence.”

## WORLDWIDE PRESENCE:

Contacts and other locations –[www.sick.com](http://www.sick.com)