

V_{DSS}	25	V
$V_{GS\ max}$	± 20	V
$R_{DS(on)\ max}$ (@ $V_{GS} = 10V$)	7.7	m Ω
(@ $V_{GS} = 4.5V$)	13.4	
Qg (typical)	7.7	nC
I_D (@ $T_C(Bottom) = 25^\circ C$)	25 \varnothing	A

HEXFET® Power MOSFET

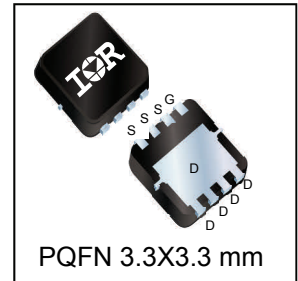
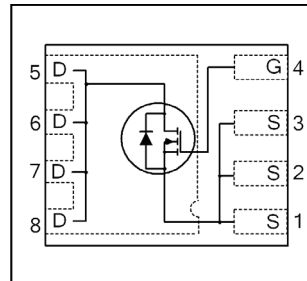

Applications

- Control MOSFET for synchronous buck converter

Features

Low Thermal Resistance to PCB (<4.1°C/W)
Low Profile (<1.05mm)
Industry-Standard Pin out
Compatible with Existing Surface Mount Techniques
RoHS Compliant, Halogen-Free
MSL1, Consumer Qualification

results in
⇒

Benefits

Enable better Thermal Dissipation
Increased Power Density
Multi-Vendor Compatibility
Easier Manufacturing
Environmentally Friendlier
Increased Reliability

Base part number	Package Type	Standard Pack		Orderable Part Number
		Form	Quantity	
IRFHM8235PbF	PQFN 3.3 mm x 3.3 mm	Tape and Reel	4000	IRFHM8235TRPbF

Absolute Maximum Ratings

	Parameter	Max.	Units
V_{GS}	Gate-to-Source Voltage	± 20	V
$I_D @ T_A = 25^\circ C$	Continuous Drain Current, $V_{GS} @ 10V$	16	A
$I_D @ T_A = 70^\circ C$	Continuous Drain Current, $V_{GS} @ 10V$	13	
$I_D @ T_C(Bottom) = 25^\circ C$	Continuous Drain Current, $V_{GS} @ 10V$	50 $\text{\textcircled{6}}$ $\text{\textcircled{7}}$	
$I_D @ T_C(Bottom) = 100^\circ C$	Continuous Drain Current, $V_{GS} @ 10V$	32 $\text{\textcircled{6}}$ $\text{\textcircled{7}}$	
$I_D @ T_C = 25^\circ C$	Continuous Drain Current, $V_{GS} @ 10V$ (Source Bonding Technology Limited)	25 \varnothing	
I_{DM}	Pulsed Drain Current $\text{\textcircled{1}}$	240 $\text{\textcircled{8}}$	
$P_D @ T_A = 25^\circ C$	Power Dissipation $\text{\textcircled{5}}$	3.0	W
$P_D @ T_C(Bottom) = 25^\circ C$	Power Dissipation $\text{\textcircled{5}}$	30	
	Linear Derating Factor $\text{\textcircled{5}}$	0.024	W/ $^\circ C$
T_J T_{STG}	Operating Junction and Storage Temperature Range	-55 to + 150	$^\circ C$

Notes $\text{\textcircled{1}}$ through $\text{\textcircled{8}}$ are on page 10

Static @ T_J = 25°C (unless otherwise specified)

	Parameter	Min.	Typ.	Max.	Units	Conditions	
BV _{DSS}	Drain-to-Source Breakdown Voltage	25	—	—	V	V _{GS} = 0V, I _D = 250μA	
ΔBV _{DSS} /ΔT _J	Breakdown Voltage Temp. Coefficient	—	19	—	mV/°C	Reference to 25°C, I _D = 1.0mA	
R _{DS(on)}	Static Drain-to-Source On-Resistance	—	6.2	7.7	mΩ	V _{GS} = 10V, I _D = 20A ③	
		—	10.3	13.4		V _{GS} = 4.5V, I _D = 16A ③	
V _{GS(th)}	Gate Threshold Voltage	1.35	1.8	2.35	V	V _{DS} = V _{GS} , I _D = 25μA	
ΔV _{GS(th)}	Gate Threshold Voltage Coefficient	—	-5.9	—	mV/°C		
I _{DSS}	Drain-to-Source Leakage Current	—	—	1.0	μA	V _{DS} = 20V, V _{GS} = 0V	
		—	—	150		V _{DS} = 20V, V _{GS} = 0V, T _J = 125°C	
I _{GSS}	Gate-to-Source Forward Leakage	—	—	100	nA	V _{GS} = 20V	
	Gate-to-Source Reverse Leakage	—	—	-100		V _{GS} = -20V	
g _{fs}	Forward Transconductance	43	—	—	S	V _{DS} = 10V, I _D = 20A	
Q _g	Total Gate Charge	—	16	—	nC	V _{GS} = 10V, V _{DS} = 13V, I _D = 20A	
Q _g	Total Gate Charge	—	7.7	12	nC	V _{DS} = 13V V _{GS} = 4.5V I _D = 20A	
	Q _{gs1}	Pre-V _{th} Gate-to-Source Charge	—	1.9			—
	Q _{gs2}	Post-V _{th} Gate-to-Source Charge	—	1.3			—
	Q _{gd}	Gate-to-Drain Charge	—	2.7			—
	Q _{godr}	Gate Charge Overdrive	—	1.5			—
Q _{sw}	Switch Charge (Q _{gs2} + Q _{gd})	—	4.0	—			
Q _{oss}	Output Charge	—	6.4	—	nC	V _{DS} = 16V, V _{GS} = 0V	
R _G	Gate Resistance	—	1.6	—	Ω		
t _{d(on)}	Turn-On Delay Time	—	7.9	—	ns	V _{DD} = 13V, V _{GS} = 4.5V I _D = 20A R _G = 1.8Ω	
t _r	Rise Time	—	16	—			
t _{d(off)}	Turn-Off Delay Time	—	7.5	—			
t _f	Fall Time	—	5.2	—			
C _{iss}	Input Capacitance	—	1040	—	pF	V _{GS} = 0V V _{DS} = 10V f = 1.0MHz	
C _{oss}	Output Capacitance	—	300	—			
C _{rss}	Reverse Transfer Capacitance	—	120	—			

Avalanche Characteristics

	Parameter	Typ.	Max.	Units
E _{AS}	Single Pulse Avalanche Energy ②	—	41	mJ

Diode Characteristics

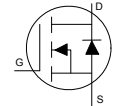
	Parameter	Min.	Typ.	Max.	Units	Conditions
I _S	Continuous Source Current (Body Diode)	—	—	25⑦	A	MOSFET symbol showing the integral reverse p-n junction diode. 
I _{SM}	Pulsed Source Current (Body Diode) ①	—	—	240⑧		
V _{SD}	Diode Forward Voltage	—	—	1.0	V	T _J = 25°C, I _S = 20A, V _{GS} = 0V ③
t _{rr}	Reverse Recovery Time	—	10	15	ns	T _J = 25°C, I _F = 20A, V _{DD} = 13V
Q _{rr}	Reverse Recovery Charge	—	4.9	7.4	nC	di/dt = 300A/μs ③

Thermal Resistance

	Parameter	Typ.	Max.	Units
R _{θJC} (Bottom)	Junction-to-Case ④	—	4.1	°C/W
R _{θJC} (Top)	Junction-to-Case ④	—	42	
R _{θJA}	Junction-to-Ambient ⑤	—	42	
R _{θJA} (<10s)	Junction-to-Ambient ⑤	—	28	

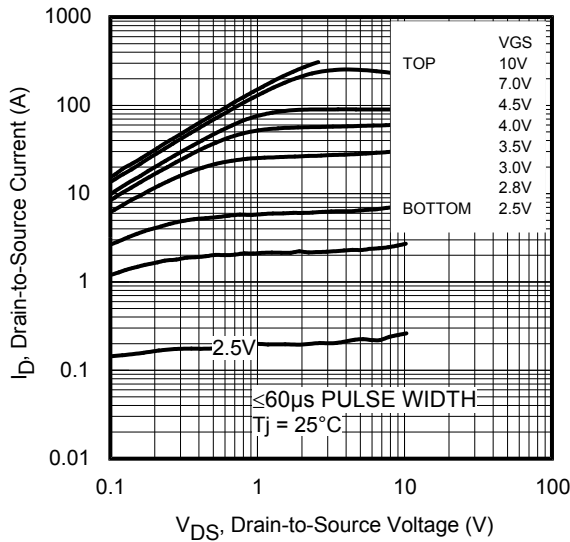
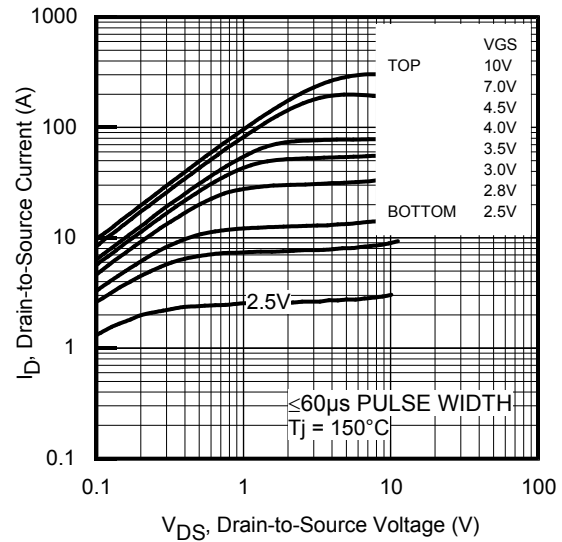
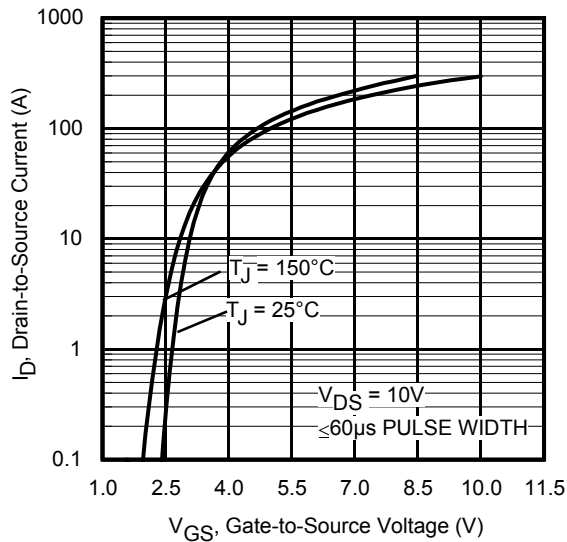
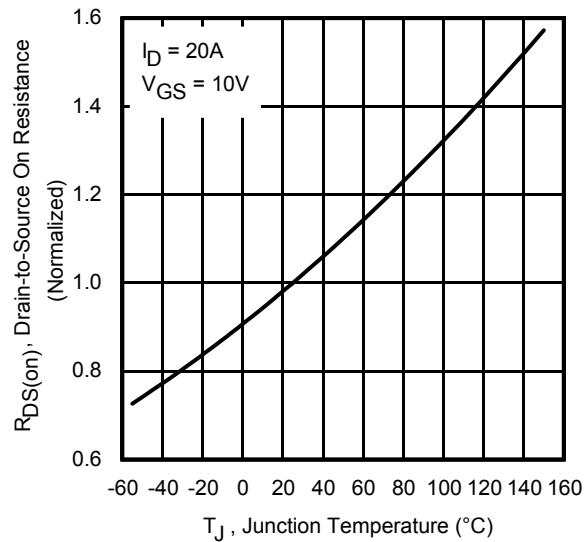
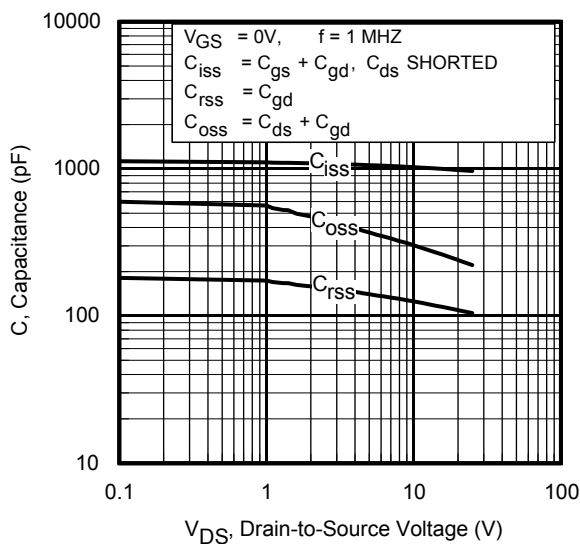
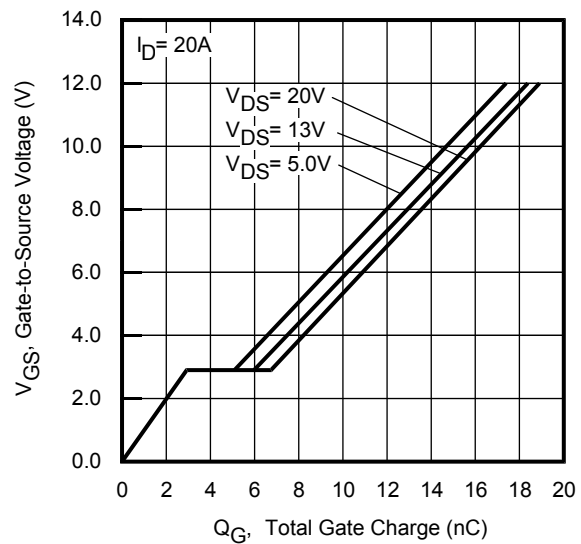
Fig 1. Typical Output Characteristics

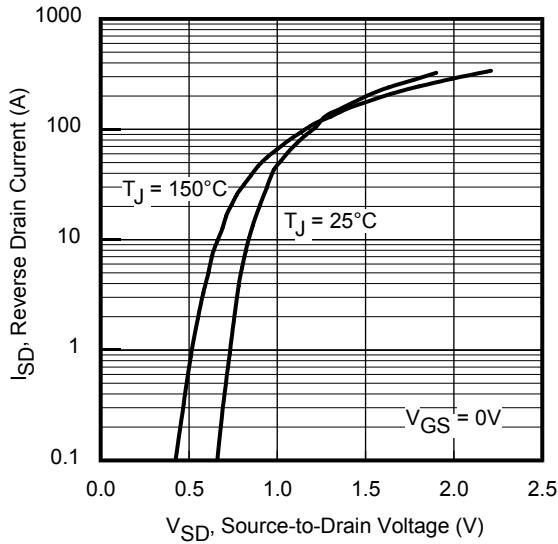
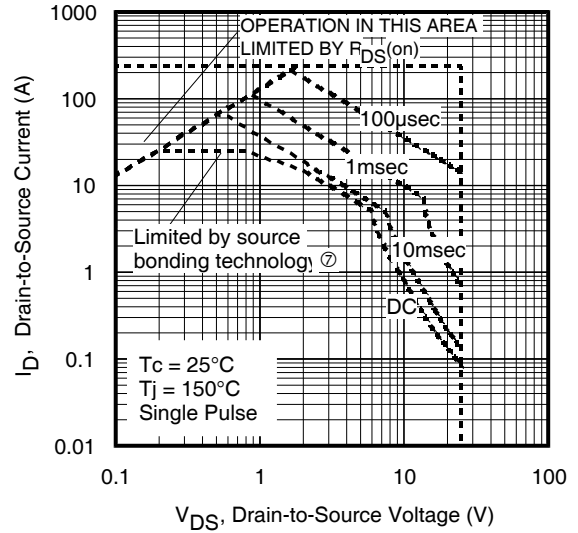
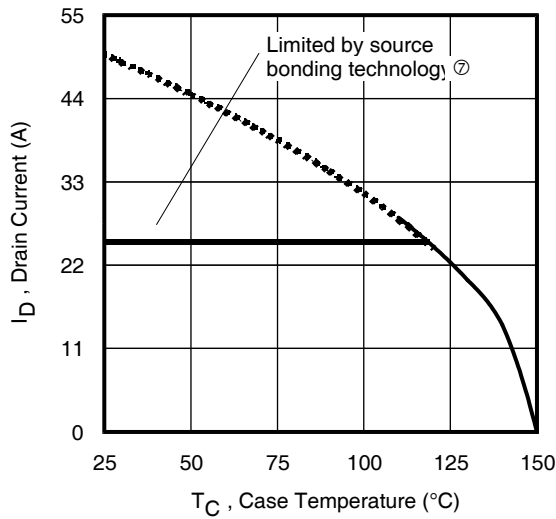
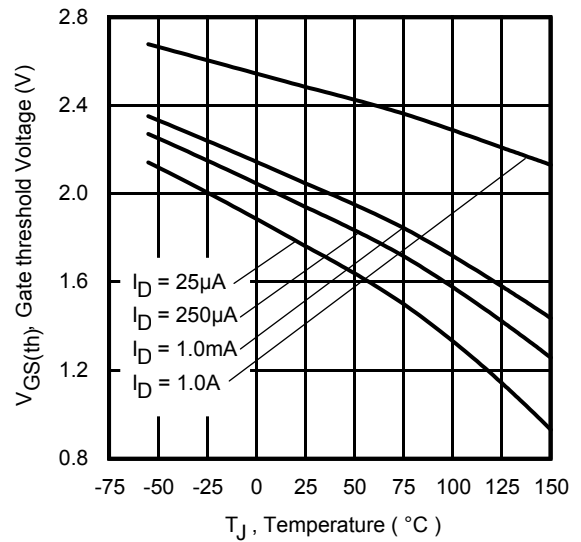
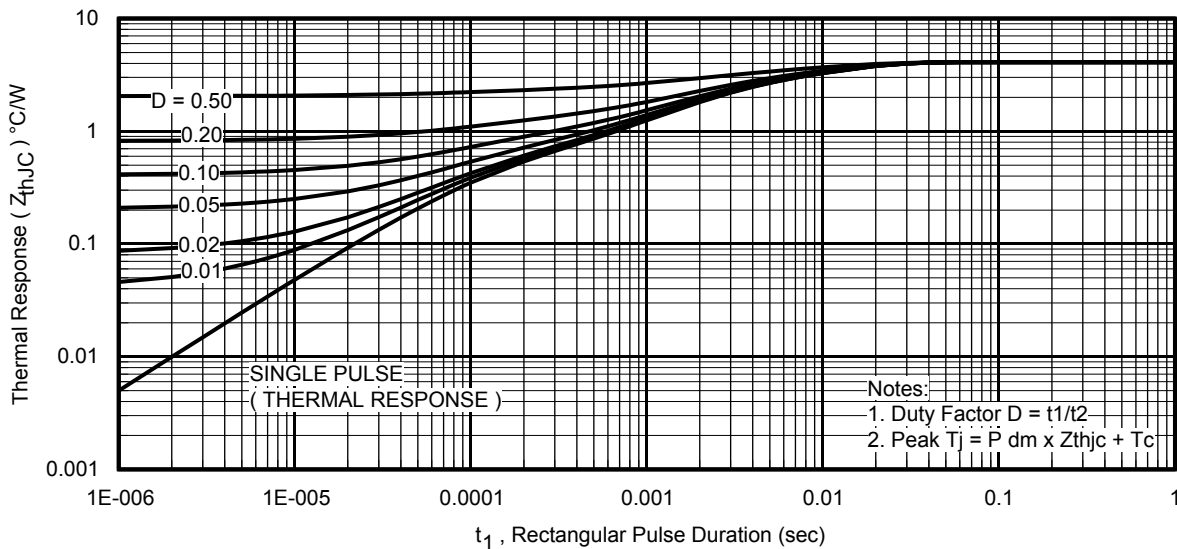
Fig 2. Typical Output Characteristics

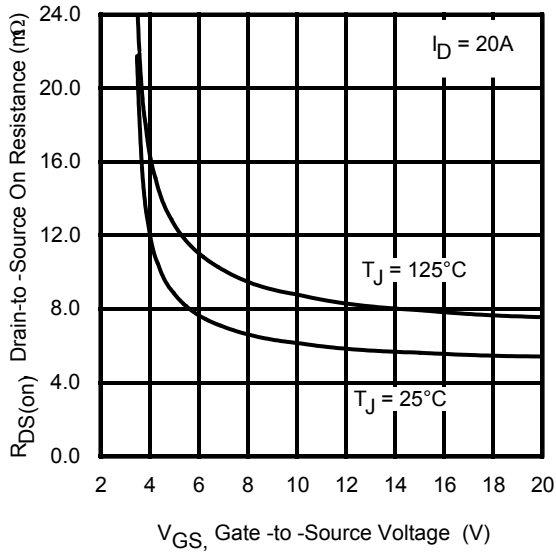
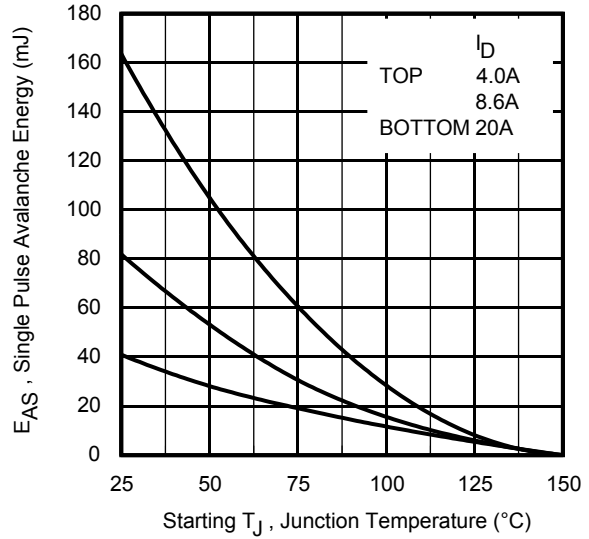
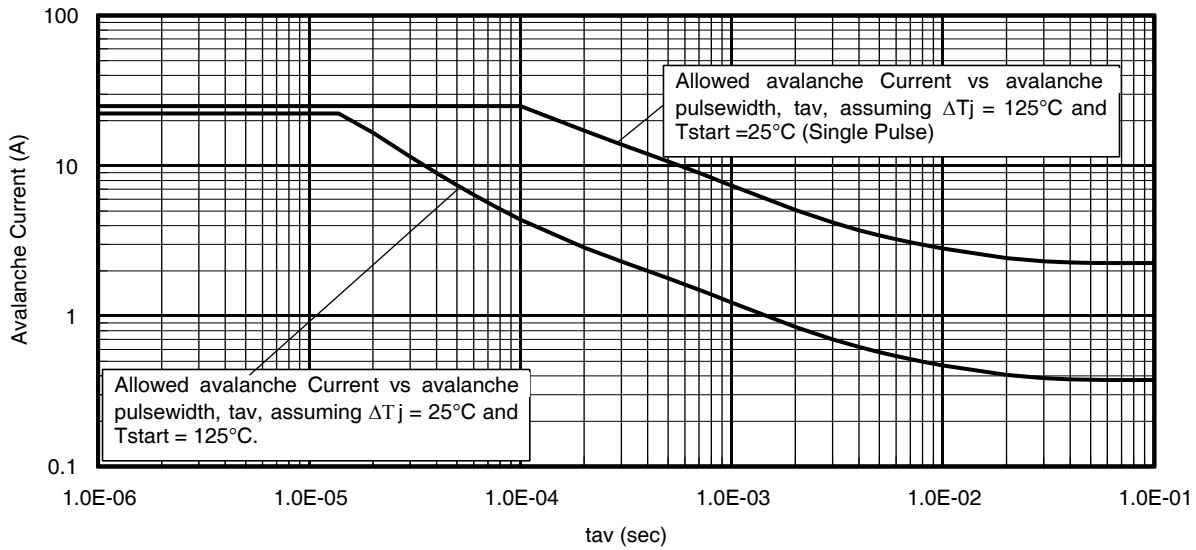
Fig 3. Typical Transfer Characteristics

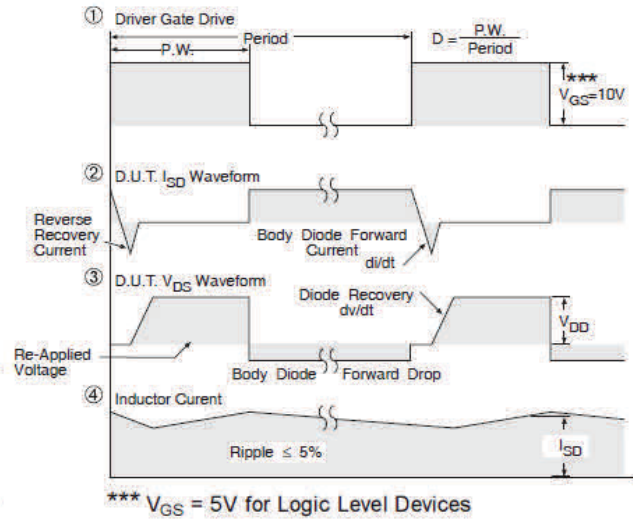
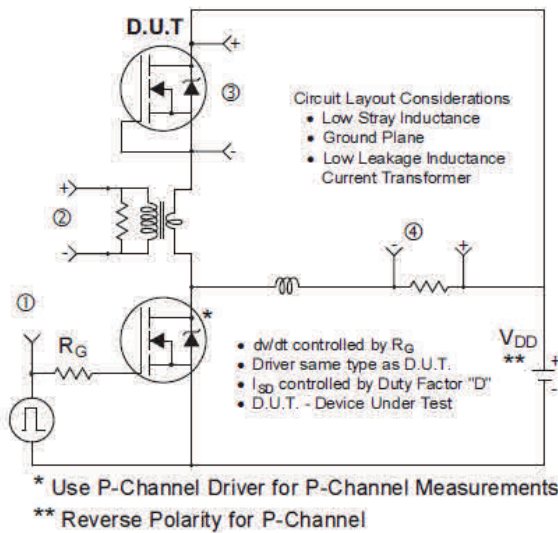
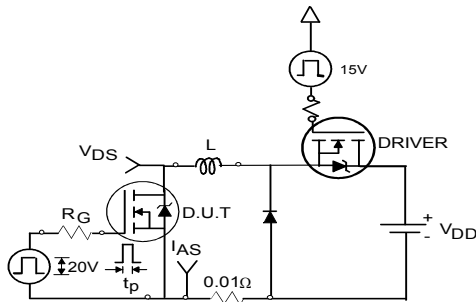
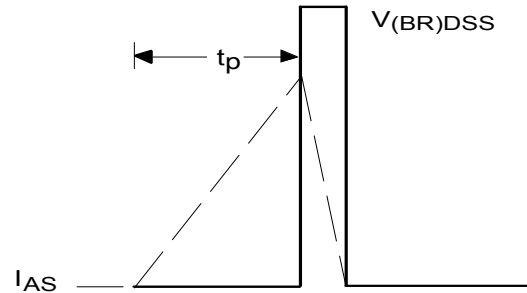
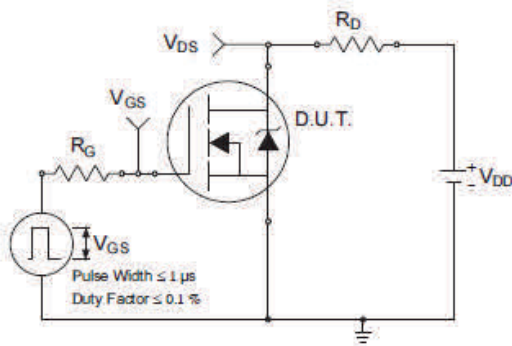
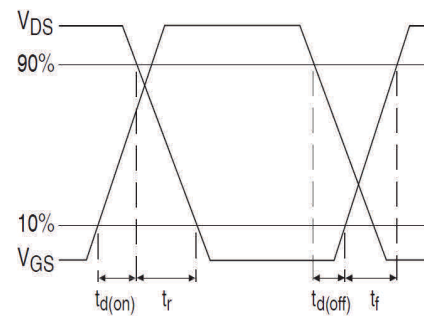
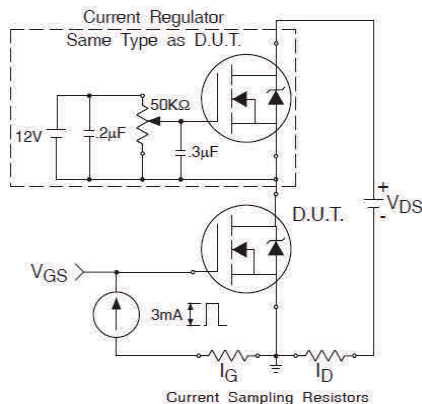
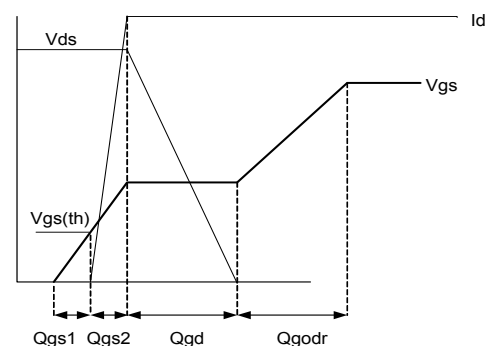
Fig 4. Normalized On-Resistance vs. Temperature

Fig 5. Typical Capacitance vs. Drain-to-Source Voltage

Fig 6. Typical Gate Charge vs. Gate-to-Source Voltage

Fig 7. Typical Source-Drain Diode Forward Voltage

Fig 8. Maximum Safe Operating Area

Fig 9. Maximum Drain Current vs. Case Temperature

Fig 10. Threshold Voltage Vs. Temperature

Fig 11. Maximum Effective Transient Thermal Impedance, Junction-to-Case

Fig 12. On-Resistance vs. Gate Voltage

Fig 13. Maximum Avalanche Energy vs. Drain Current

Fig 14. Single avalanche event: pulse current vs. pulse width

Fig 15. Peak Diode Recovery dv/dt Test Circuit for N-Channel HEXFET® Power MOSFETs

Fig 16a. Unclamped Inductive Test Circuit

Fig 16b. Unclamped Inductive Waveforms

Fig 17a. Switching Time Test Circuit

Fig 17b. Switching Time Waveforms

Fig 18a. Gate Charge Test Circuit

Fig 18b. Gate Charge Waveform

Placement and Layout Guidelines

The typical application topology for this product is the synchronous buck converter. These converters operate at high frequencies (typically around 400 kHz). During turn-on and turn-off switching cycles, the high di/dt currents circulating in the parasitic elements of the circuit induce high voltage ringing which may exceed the device rating and lead to undesirable effects. One of the major contributors to the increase in parasitics is the PCB power circuit inductance.

This section introduces a simple guideline that mitigates the effect of these parasitics on the performance of the circuit and provides reliable operation of the devices.

To reduce high frequency switching noise and the effects of Electromagnetic Interference (EMI) when the control MOSFET (Q1) is turned on, the layout shown in Figure 19 is recommended. The input bypass capacitors, control MOSFET and output capacitors are placed in a tight loop to minimize parasitic inductance which in turn lowers the amplitude of the switch node ringing, and minimizes exposure of the MOSFETs to repetitive avalanche conditions.

When the synchronous MOSFET (Q2) is turned on, high average DC current flows through the path indicated in Figure 19. Therefore, the Q2 turn-on path should be laid out with a tight loop and wide traces at both ends of the inductor to minimize loop resistance.

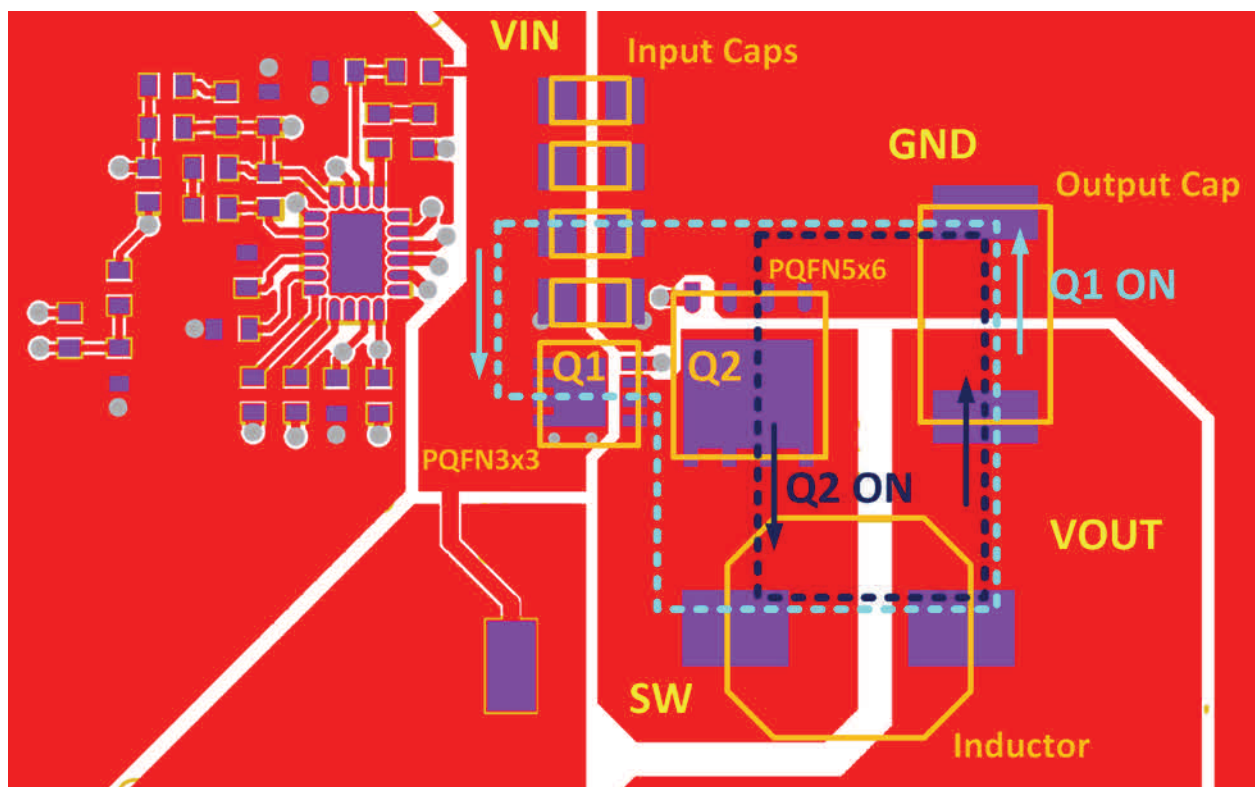

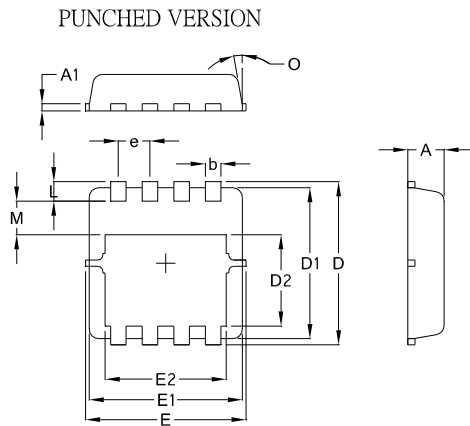
PQFN 3.3mm x 3.3mm Outline Package Details

SYMBOL	COMMON			
	MM		INCH	
	MIN.	MAX.	MIN.	MAX.
A	0.70	1.05	0.0276	0.0413
A1	0.12	0.39	0.0047	0.0154
b	0.25	0.39	0.0098	0.0154
D	3.20	3.45	0.1260	0.1358
D1	3.00	3.20	0.1181	0.1417
D2	1.69	2.20	0.0665	0.0866
E	3.20	3.40	0.1260	0.1339
E1	3.00	3.20	0.1181	0.1417
E2	2.15	2.59	0.0846	0.1020
e	0.65 BSC		0.0256 BSC	
L	0.15	0.55	0.0059	0.0217
M	0.59	—	0.0232	—
O	9Deg	12Deg	9Deg	12Deg

For more information on board mounting, including footprint and stencil recommendation, please refer to application note AN-1136: <http://www.irf.com/technical-info/appnotes/an-1136.pdf>

For more information on package inspection techniques, please refer to application note AN-1154: <http://www.irf.com/technical-info/appnotes/an-1154.pdf>

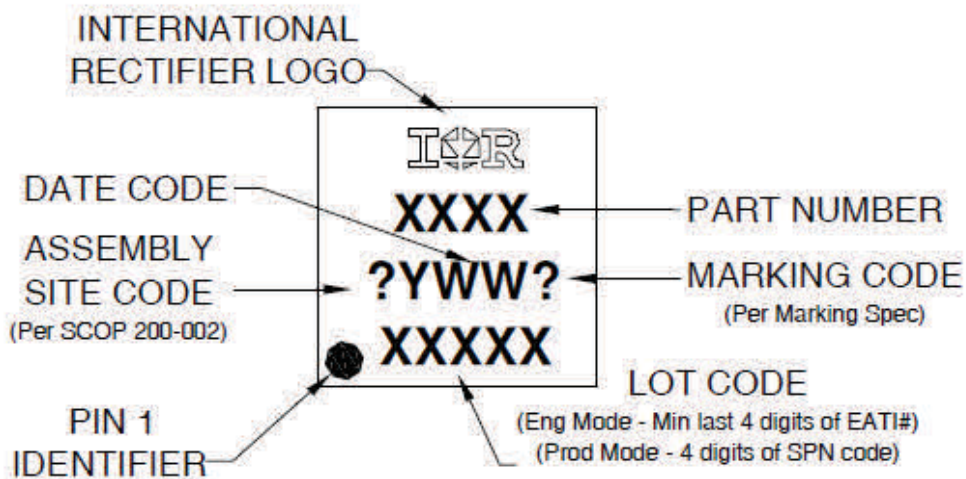
PQFN 3.3mm x 3.3mm Outline Part Marking

Note: For the most current drawing please refer to IR website at <http://www.irf.com/package/>

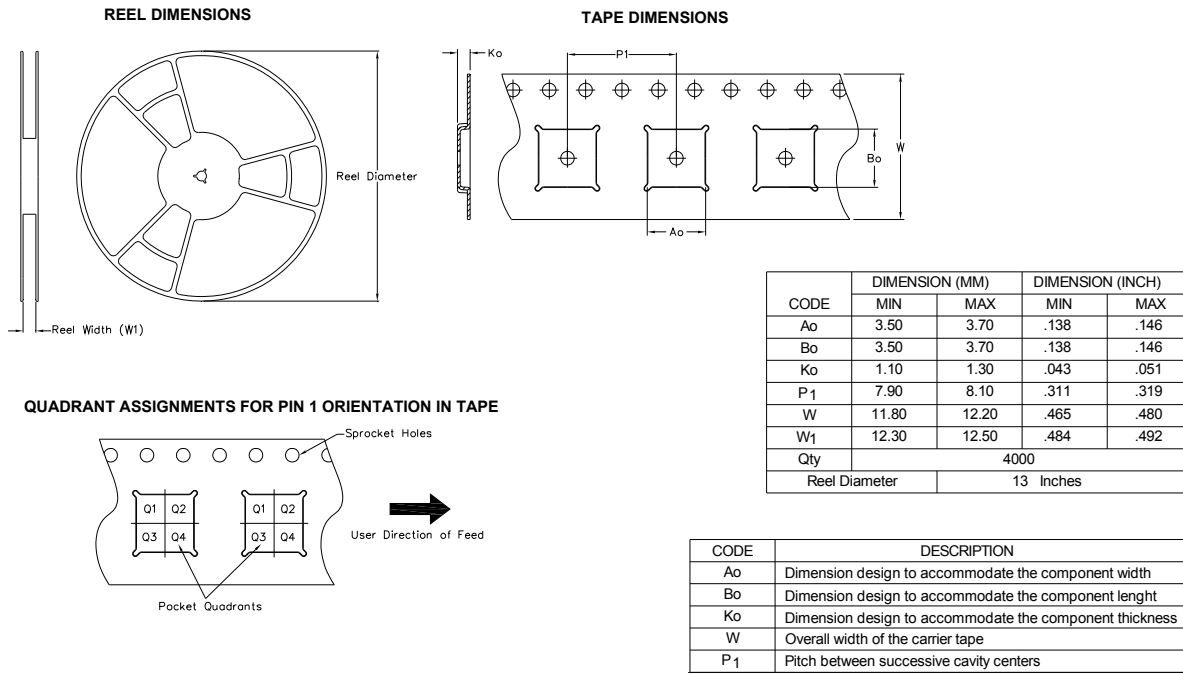
PQFN 3.3mm x 3.3mm Outline Tape and Reel

Note: For the most current drawing please refer to IR website at <http://www.irf.com/package/>

Qualification Information†

Qualification Level	Consumer ^{††} (per JEDEC JESD47F guidelines)	
Moisture Sensitivity Level	PQFN 3.3mm x 3.3mm	MSL1 (per JEDEC J-STD-020D ^{†††})
RoHS Compliant	Yes	

† Qualification standards can be found at International Rectifier’s web site: <http://www.irf.com/product-info/reliability/>

†† Higher qualification ratings may be available should the user have such requirements. Please contact your International Rectifier sales representative for further information: <http://www.irf.com/whoto-call/salesrep/>

††† Applicable version of JEDEC standard at the time of product release.

Notes:

- ① Repetitive rating; pulse width limited by max. junction temperature.
- ② Starting $T_J = 25^\circ\text{C}$, $L = 0.21\text{mH}$, $R_G = 50\Omega$, $I_{AS} = 20\text{A}$.
- ③ Pulse width $\leq 400\mu\text{s}$; duty cycle $\leq 2\%$.
- ④ R_θ is measured at T_J of approximately 90°C .
- ⑤ When mounted on 1 inch square 2 oz copper pad on 1.5x1.5 in. board of FR-4 material. Please refer to AN-994 for more details: <http://www.irf.com/technical-info/appnotes/an-994.pdf>
- ⑥ Calculated continuous current based on maximum allowable junction temperature.
- ⑦ Current is limited to 25A by source bonding technology.
- ⑧ Pulse drain current is limited to 100A by source bonding technology.

Revision History

Date	Comments
6/5/14	<ul style="list-style-type: none"> • Updated schematic on page 1 • Updated part marking on page 8 • Updated tape and reel on page 9
6/30/14	<ul style="list-style-type: none"> • Remove “SAWN” package outline on page 8.