

SPECIFICATION

- Part No. : **CGGBP.25.4.A.02**
- Product Name : Embedded 25mm GPS/GLONASS/BEIDOU
Patch Antenna, 1561/1575/1602MHz
- Feature : 25*25*4mm Ceramic patch
High Gain (up to 3.5dBi)
Excellent stability on the three GNSS systems
Optimized radiation patterns
Pin Mount
RoHS Compliant



1. Introduction

This 25mm square embedded ceramic GPS/GLONASS/BEIDOU patch antenna's wide band of operation leads to excellent gain and radiation pattern stability on all three common commercial GNSS systems worldwide.

Compared to using a smaller antenna, this will translate into the GNSS system having much higher location accuracy, improved reliability of lock in urban areas, better signal reception, with more satellites acquired and a quicker time to first fix.

The patch is mounted via pin and double-sided adhesive.

2. Specification

ELECTRICAL	
Frequency	BeiDou: 1561.098MHz \pm 2.046MHz GPS: 1575.42 \pm 1.023MHz GLONASS: 1602 \pm 5MHz
Centre Frequency	1582MHz \pm 3MHz
VSWR	BeiDou: 2.5 max. GPS: 2.5 max. GLONASS: 1.8 max.
Zenith Gain	BeiDou: +2.5 dBi typ. GPS: +1.5dBi typ. GLONASS: +3.5 dBi typ.
Impedance	50 Ω
MECHANICAL	
Dimensions	25 x 25 x 4mm
Material	Ceramic
Pin Diameter	0.9mm
Pin Length	1.65mm
ENVIRONMENTAL	
Operation Temperature	-40°C to 85°C
Storage Temperature	-40°C to 105°C
Humidity	Non-condensing 65°C 95% RH

3. Antenna Characteristics

3.1 S11 Impedance

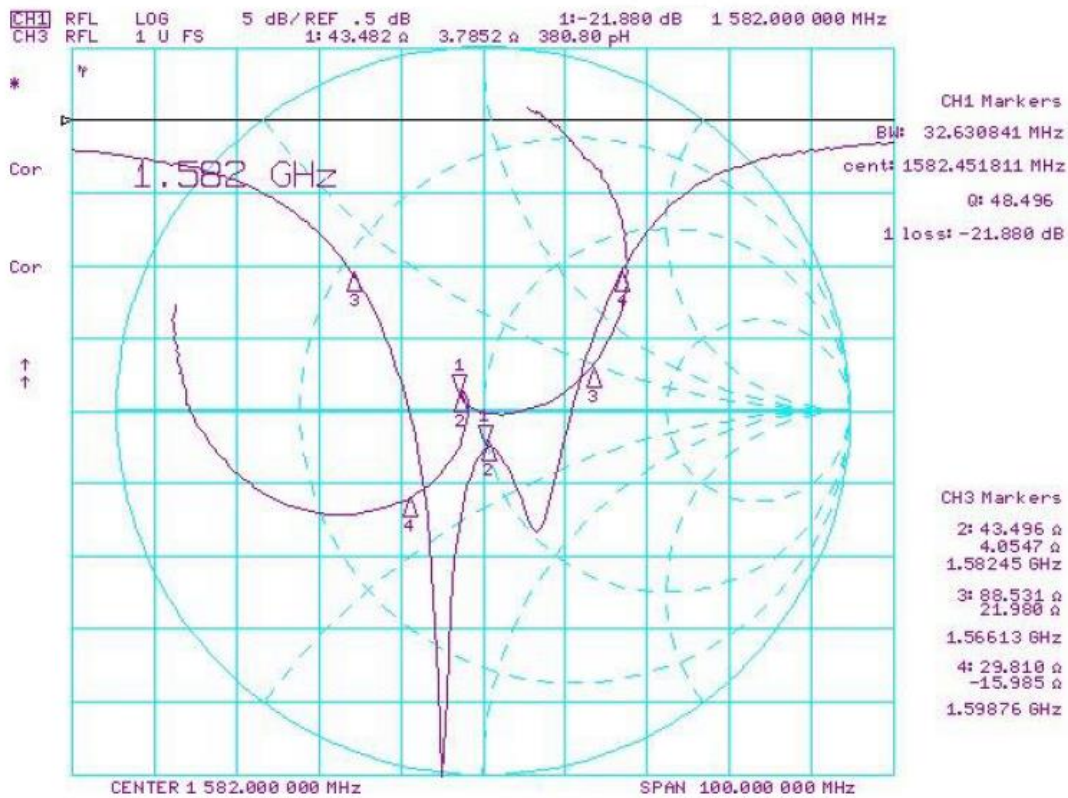

3.2 Return Loss

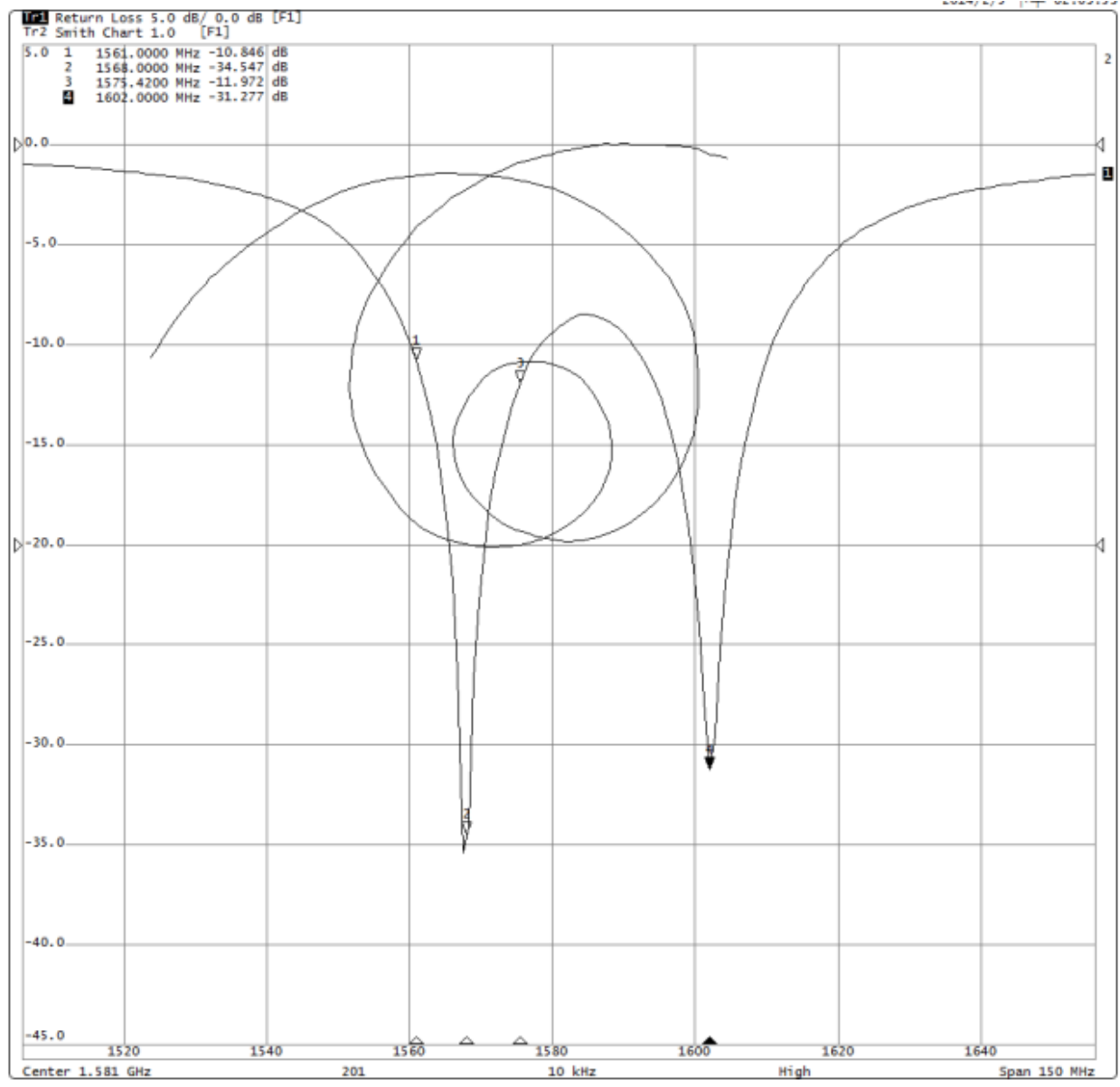

4. 2D Antenna Radiation

XZ-Plane

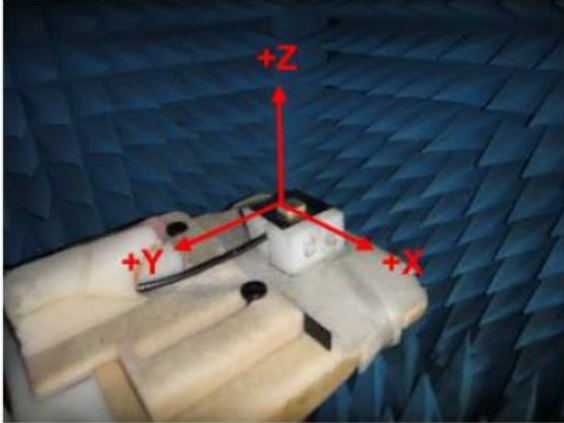

YZ-Plane

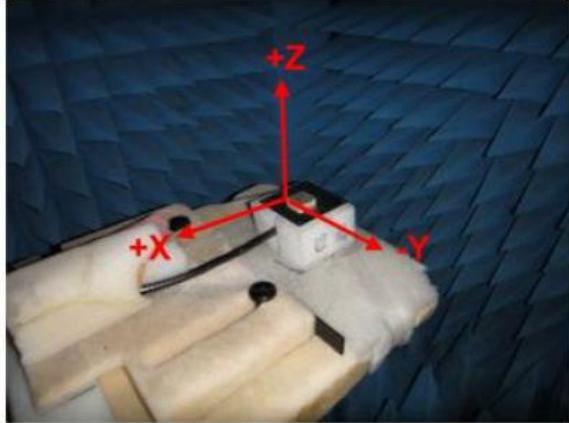

4.1 1575.42MHz

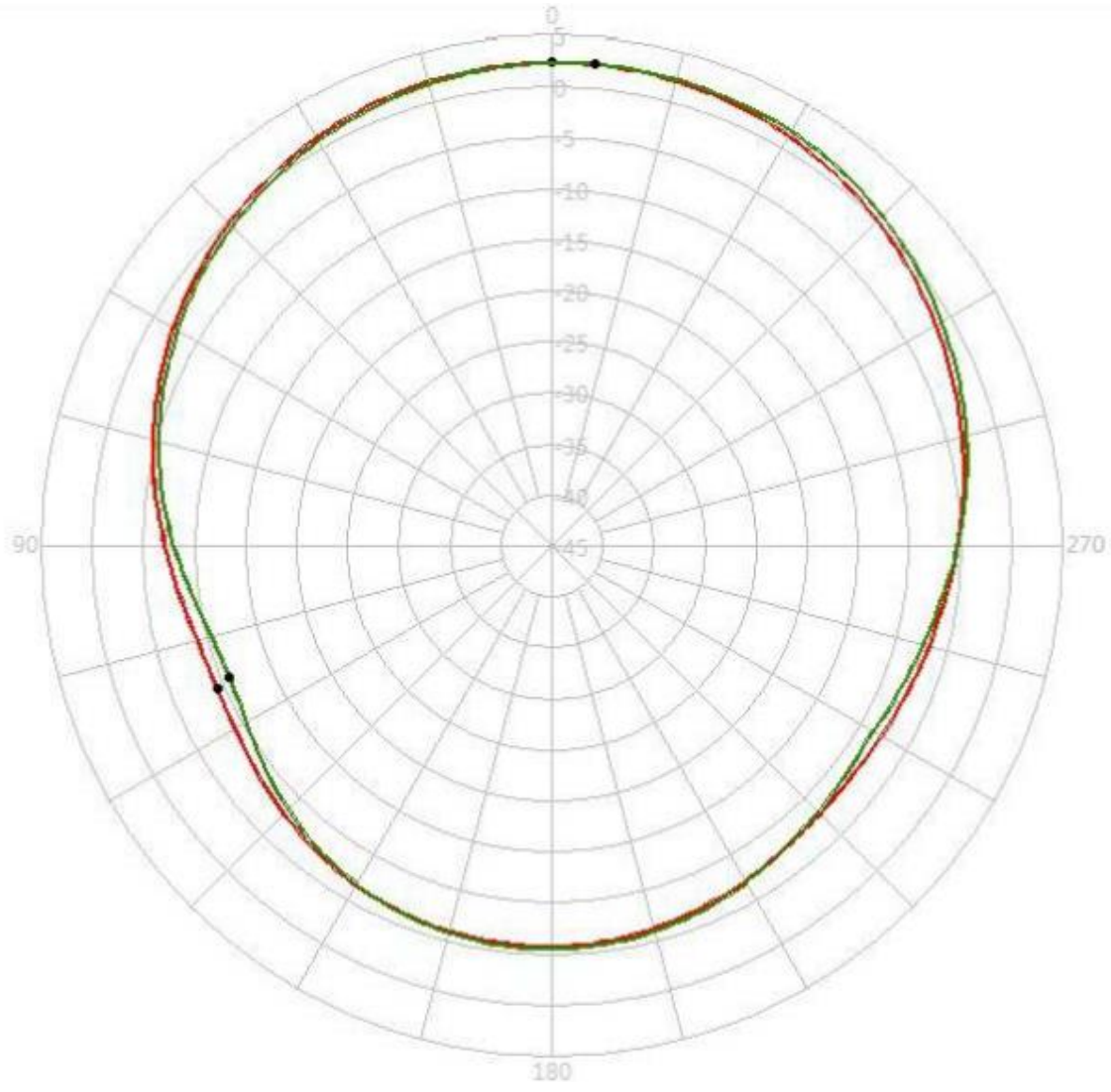

	Peak Gain (dBi)	Average Gain (dBi)
XZ Plane	2.39	-2.26
YZ Plane	2.38	-2.25

4.2 1561MHz

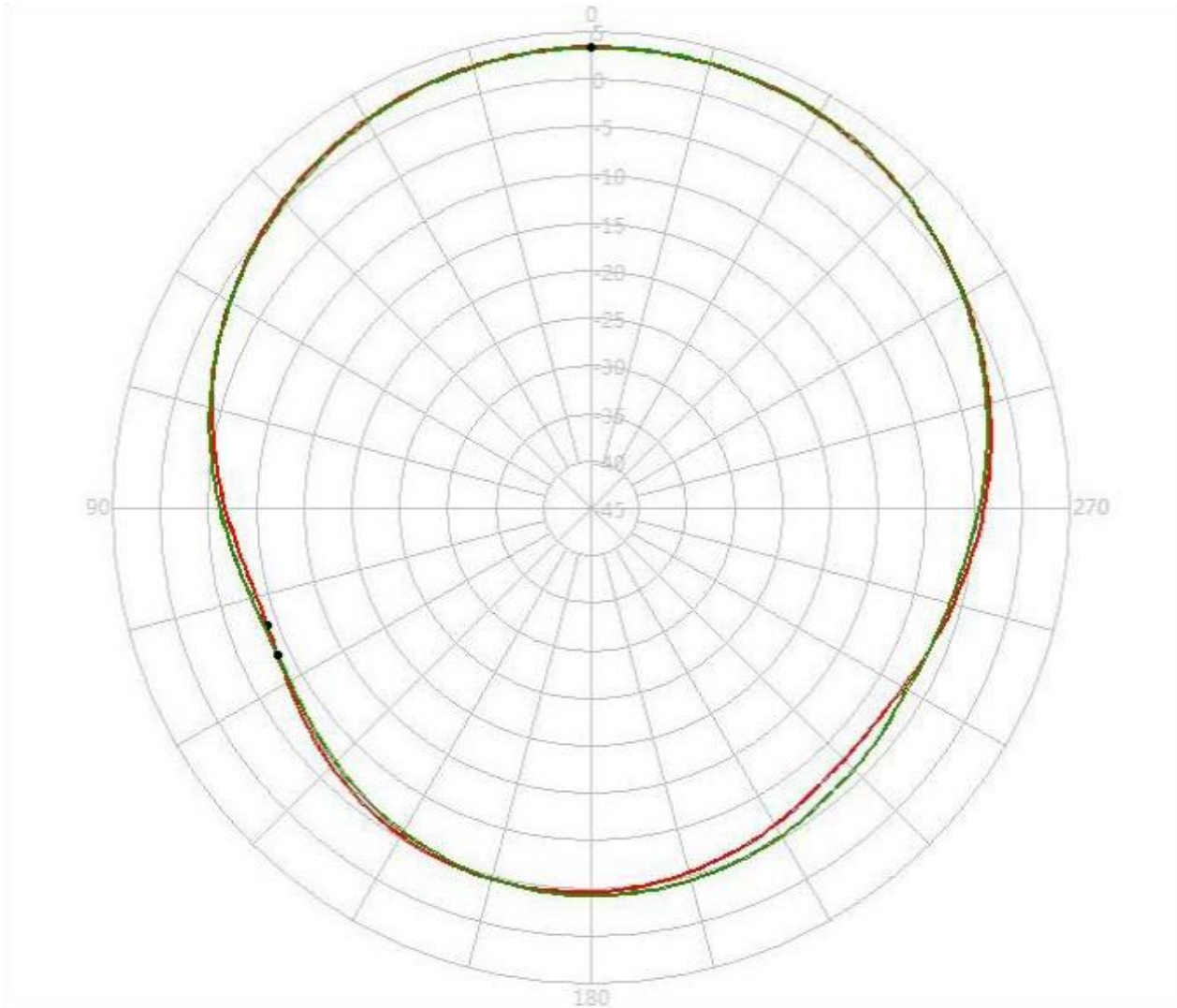

	Peak Gain (dBi)	Average Gain (dBi)
XZ Plane	3.41	-1.20
YZ Plane	3.36	-1.19

4.3 1602MHz

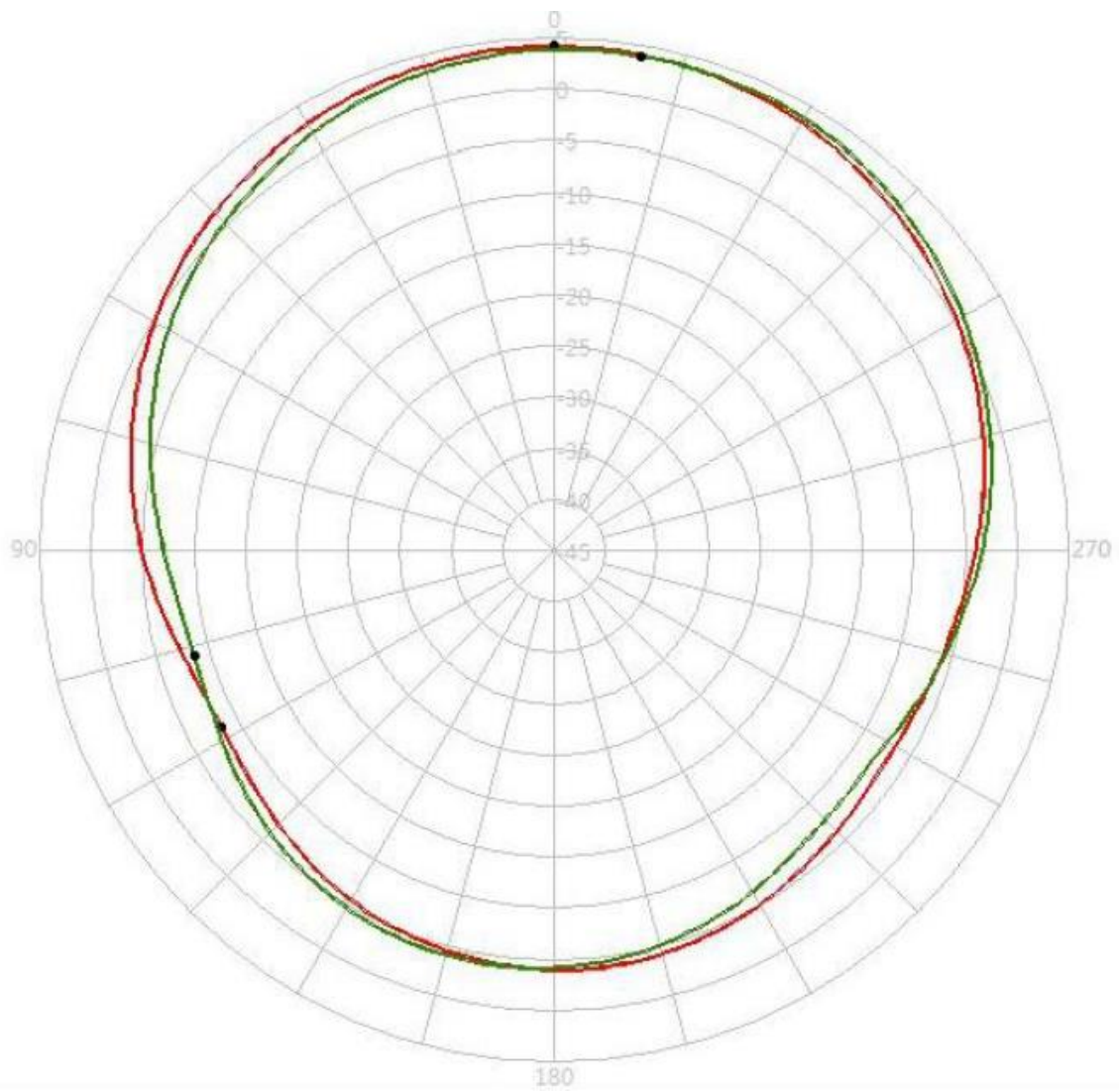

	Peak Gain (dBi)	Average Gain (dBi)
XZ Plane	4.21	-0.48
YZ Plane	3.95	-0.73

5. Mechanical Drawing-Patch

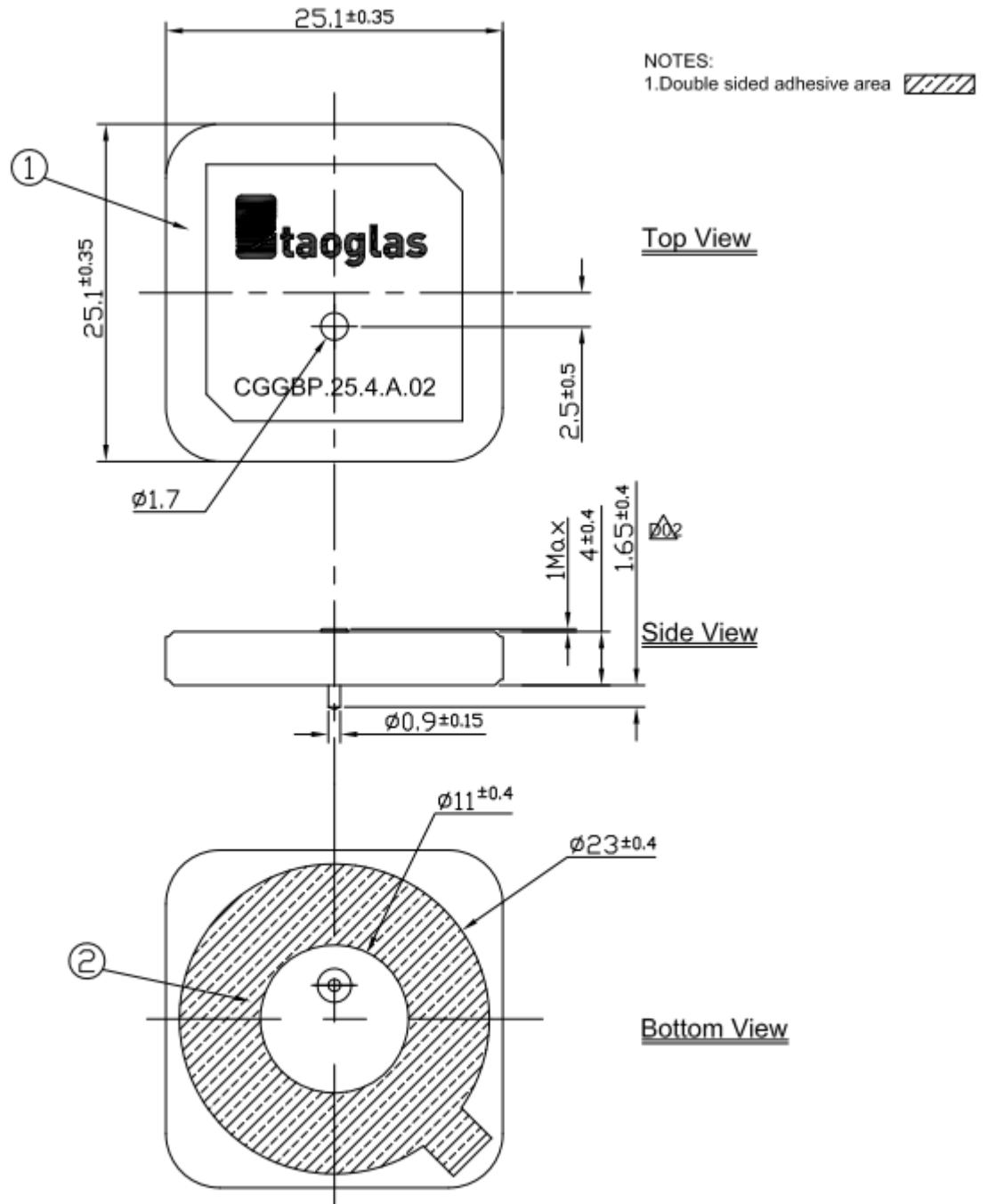

	Name	Material	Finish	QTY
1	Patch 25x25x4	Ceramic	Clear	1
1	Double sided Adhesive	NITTO5015	White Liner	1

5.1 Adhesive Thickness

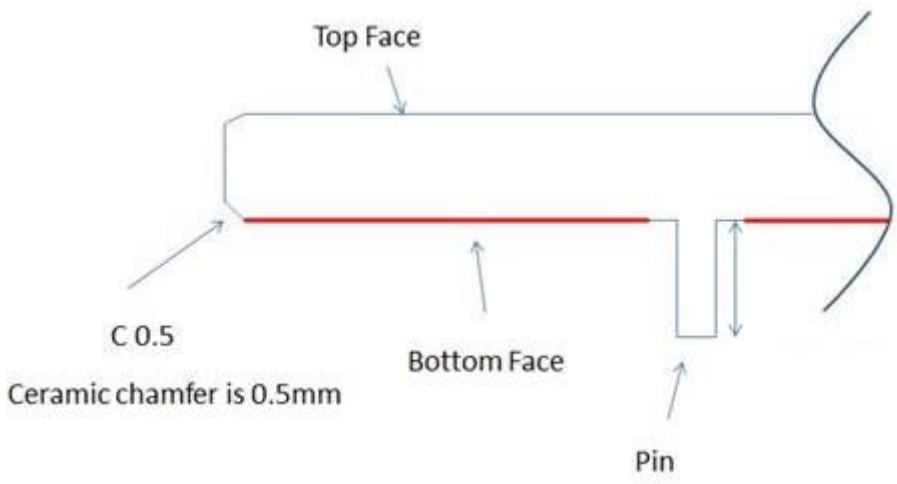

Red Line shows the adhesive without Liner – thickness 0.08~0.1mm

6. CGGBP.D.25.A EVB

Top View

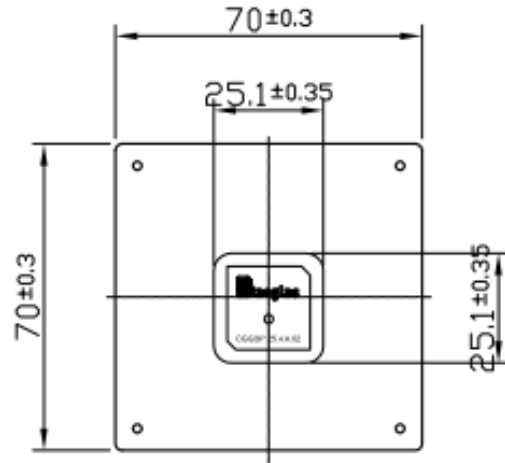

Side View

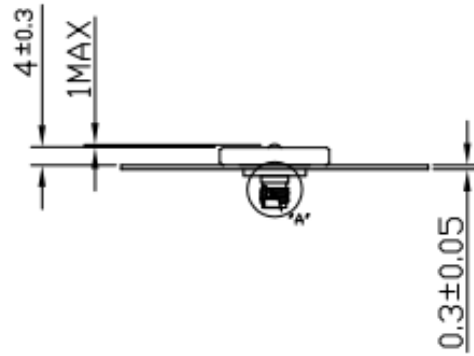

Bottom View

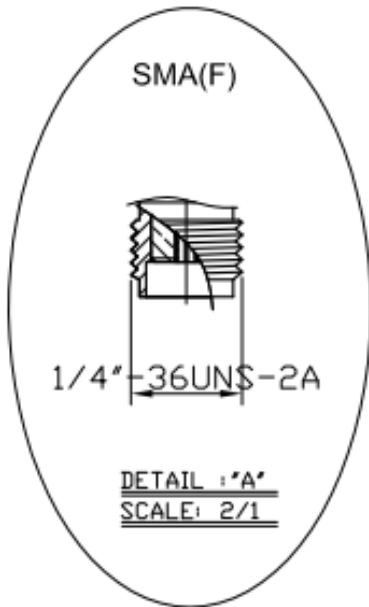
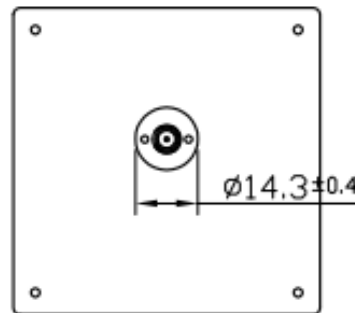

	Name	Material	Finish	QTY
1	Patch(25x25x4mm)	Ceramic	Clear	1
2	Ground-Plane(70x70x0.3mm)	Brass	Silver	1
3	SMA(F) ST	Brass	Gold	1



CGGBP.25.4.A.02 Patch on 70*70mm Ground Plane

7. PCB Footprint Recommendation

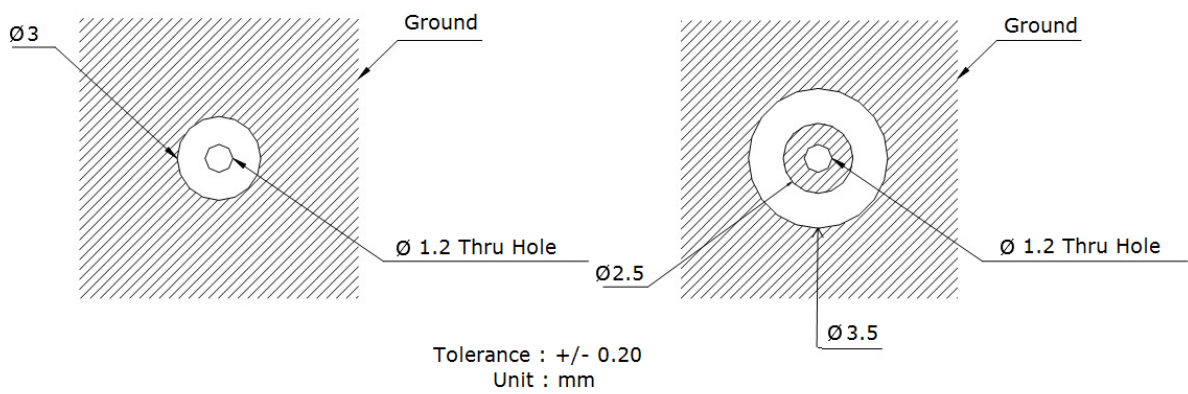

8. Packaging

8.1 Inner Tray

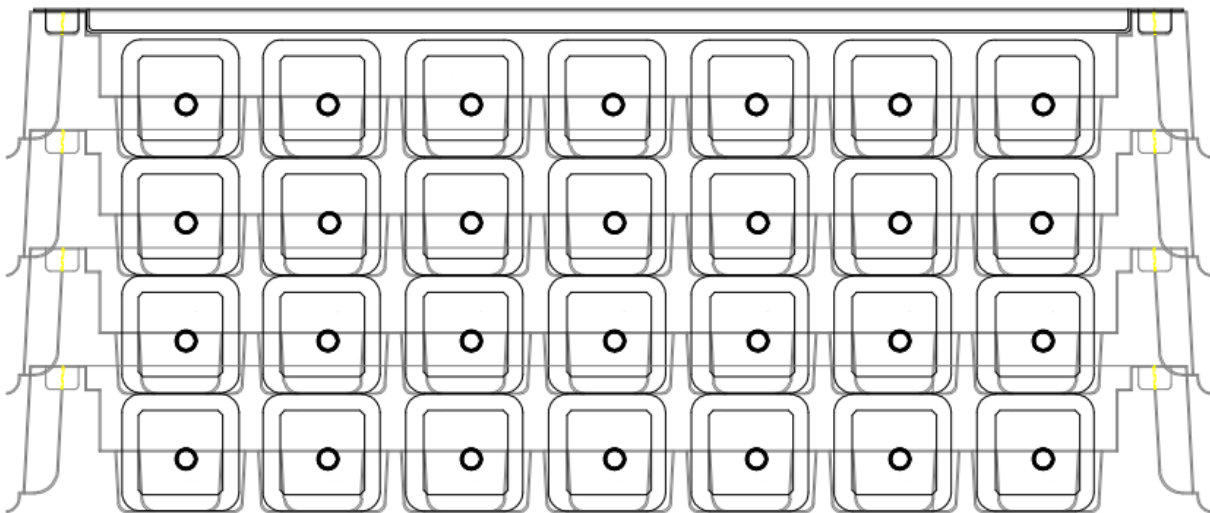
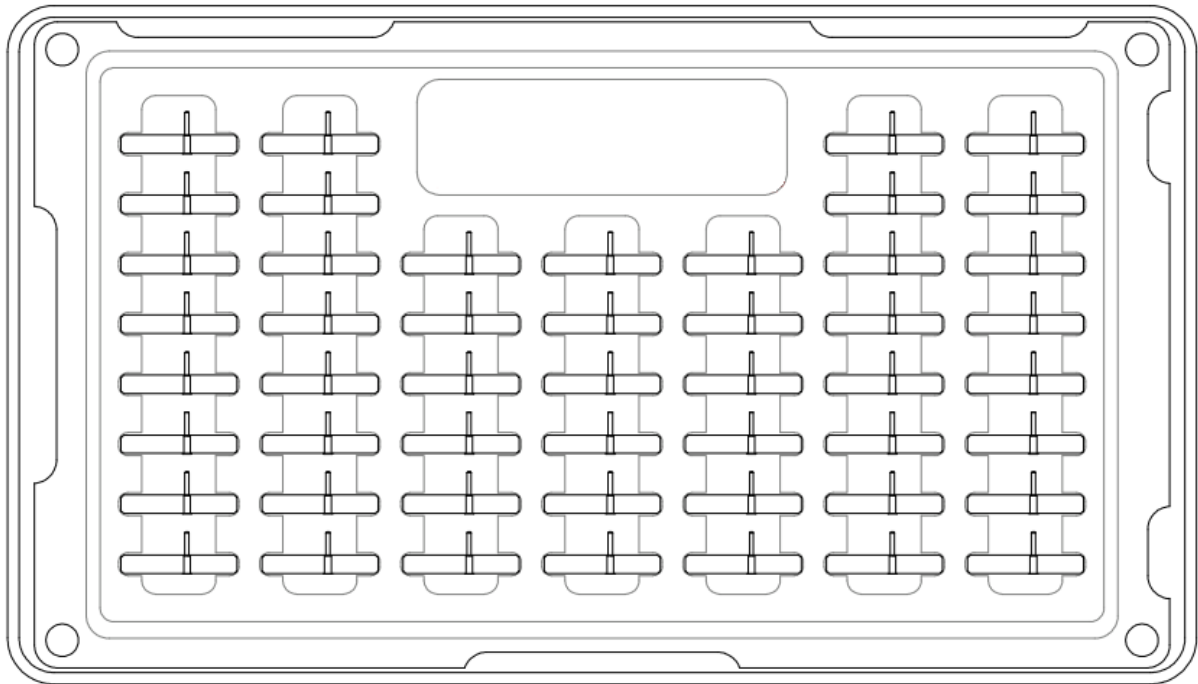

50 pieces per tray

4 Trays per Inside Box = 200

4 Inside Boxes per Outer Carton -Outer Carton contains 800 pieces

8.2 Carton

