

SPECIFICATION

Part No.	:	CGGBP.18.4.A.02
Product Name	:	18mm*18mm*4mm GPS/GLONASS/BEIDOU Embedded Patch Antenna BEIDOU 1561MHz / GPS 1575MHz / GLONASS 1602MHz
Feature	:	Dielectric Ceramic Pin Mount RoHS Compliant

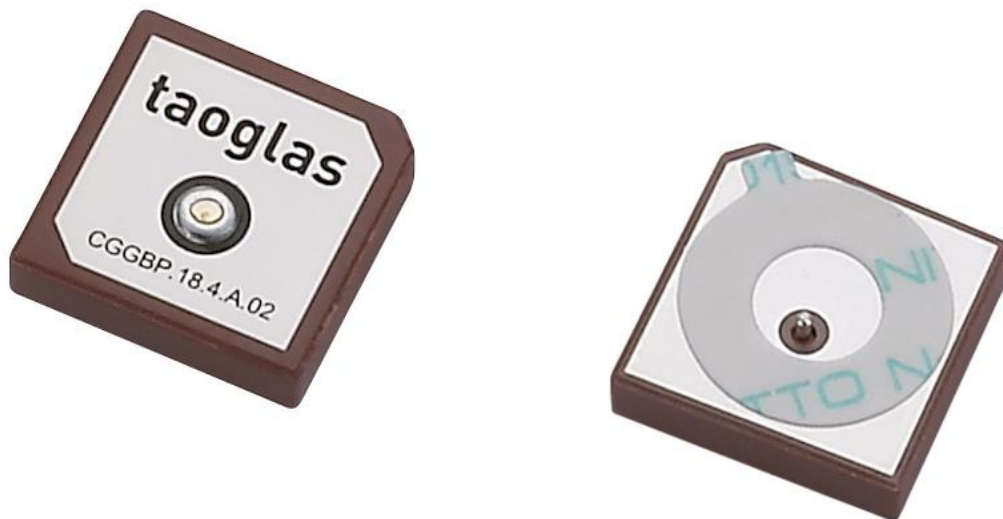

1. Introduction

This 18mm*18mm square ceramic GPS/GLONASS/BEIDOU patch antenna's wide band of operation leads to excellent gain and radiation pattern stability on all three GNSS system bands.

Compared to using a smaller antenna, this will translate into the GNSS system having much higher location accuracy, improved reliability of lock in urban areas, better signal reception, with more satellites acquired and a quicker time to first fix.

The patch is mounted via pin and double-sided adhesive.

2. Specification

ELECTRICAL	
Frequency	BeiDou: 1561.098MHz ± 2.046MHz GPS: 1575.42 ± 1.023MHz GLONASS: 1602 ± 5MHz
Centre Frequency	1583MHz ± 3MHz
VSWR	BeiDou: 2.8 max. GPS: 2.8 max. GLONASS: 1.8 max.
Bandwidth	26MHz Return Loss @-10dB
Zenith Gain	BeiDou: +3.0dBi typ. GPS: +2.0dBi typ. GLONASS: +4.0dBi typ.
Impedance	50 Ω
MECHANICAL	
Dimensions	18*18*4mm
Material	Ceramic
Pin Diameter	0.9mm
Pin Length	1.65mm
ENVIRONMENTAL	
Operation Temperature	-40°C to 85°C
Storage Temperature	-40°C to 105°C
Humidity	Non-condensing 65°C 95% RH

*measured on a 70*70mm Ground Plane

3. Antenna Characteristics

3.1 S11 Impedance

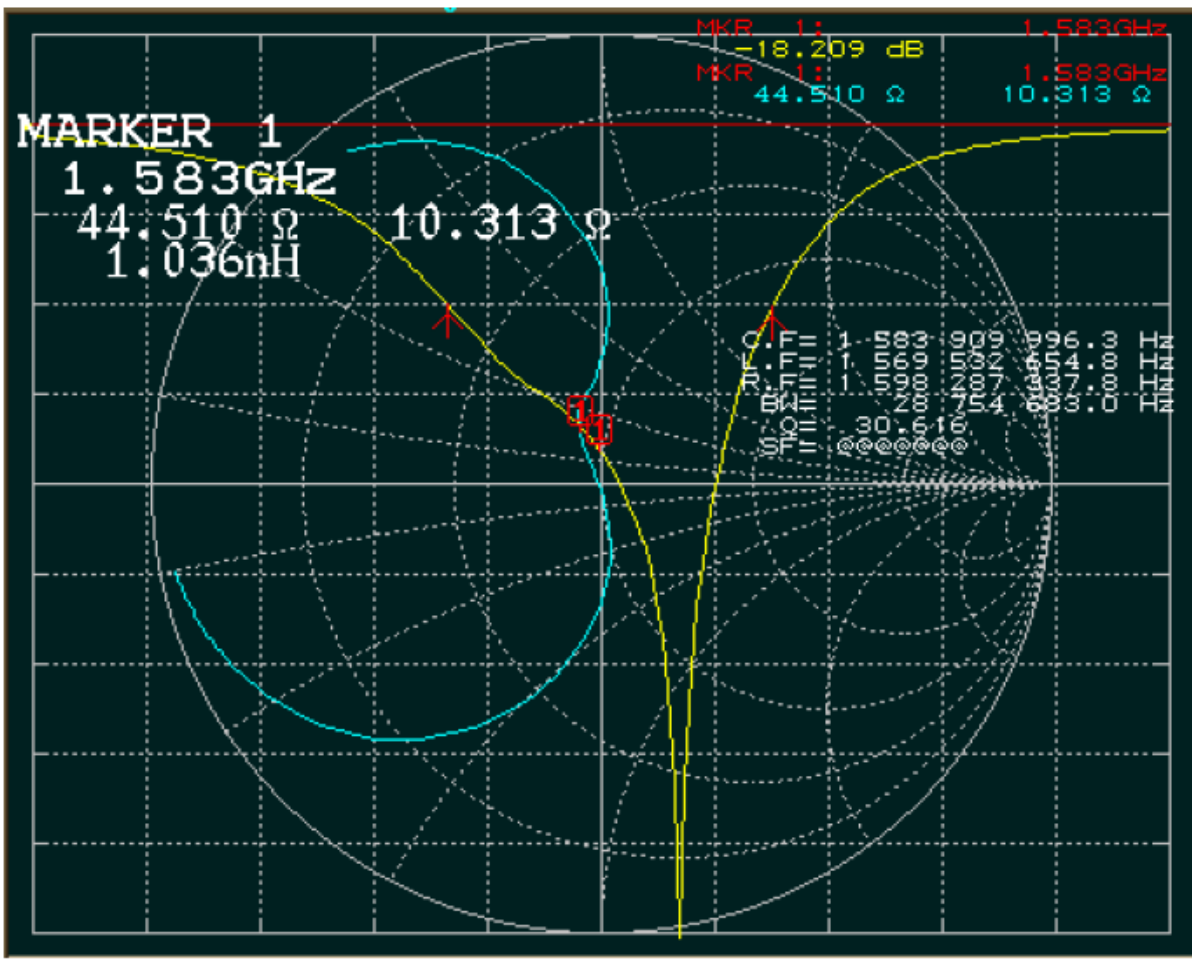

3.2 Return Loss

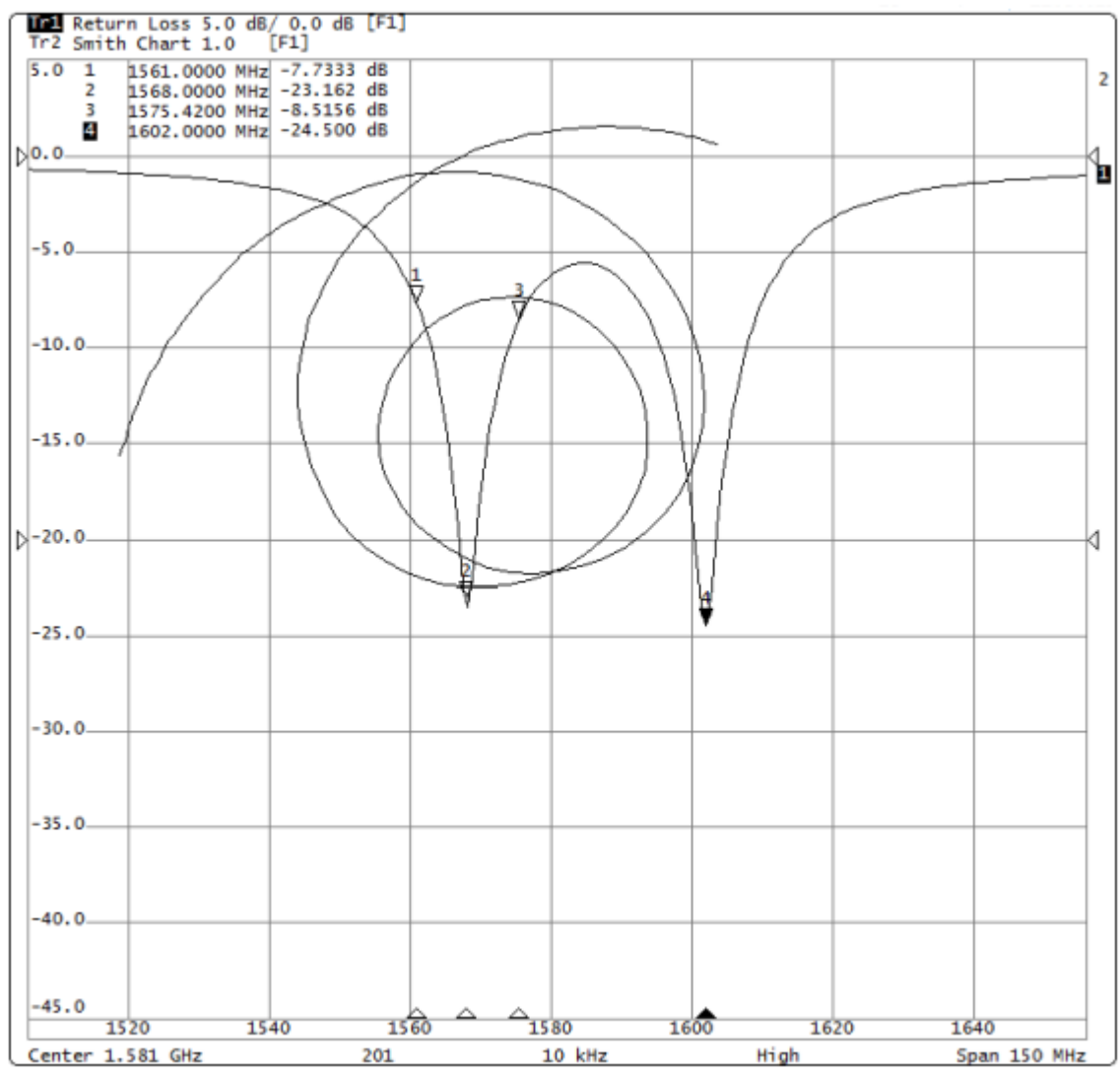

4. 2D Antenna Radiation

XZ-Plane

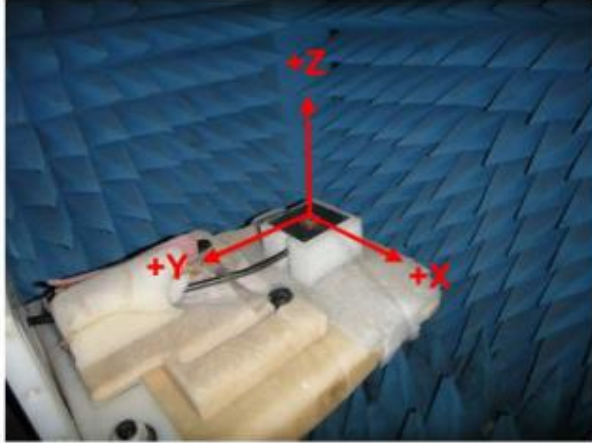

YZ-Plane

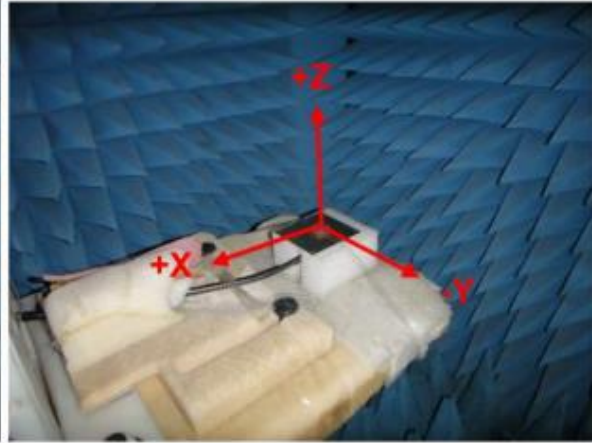

4.1 1575.42MHz Free Space

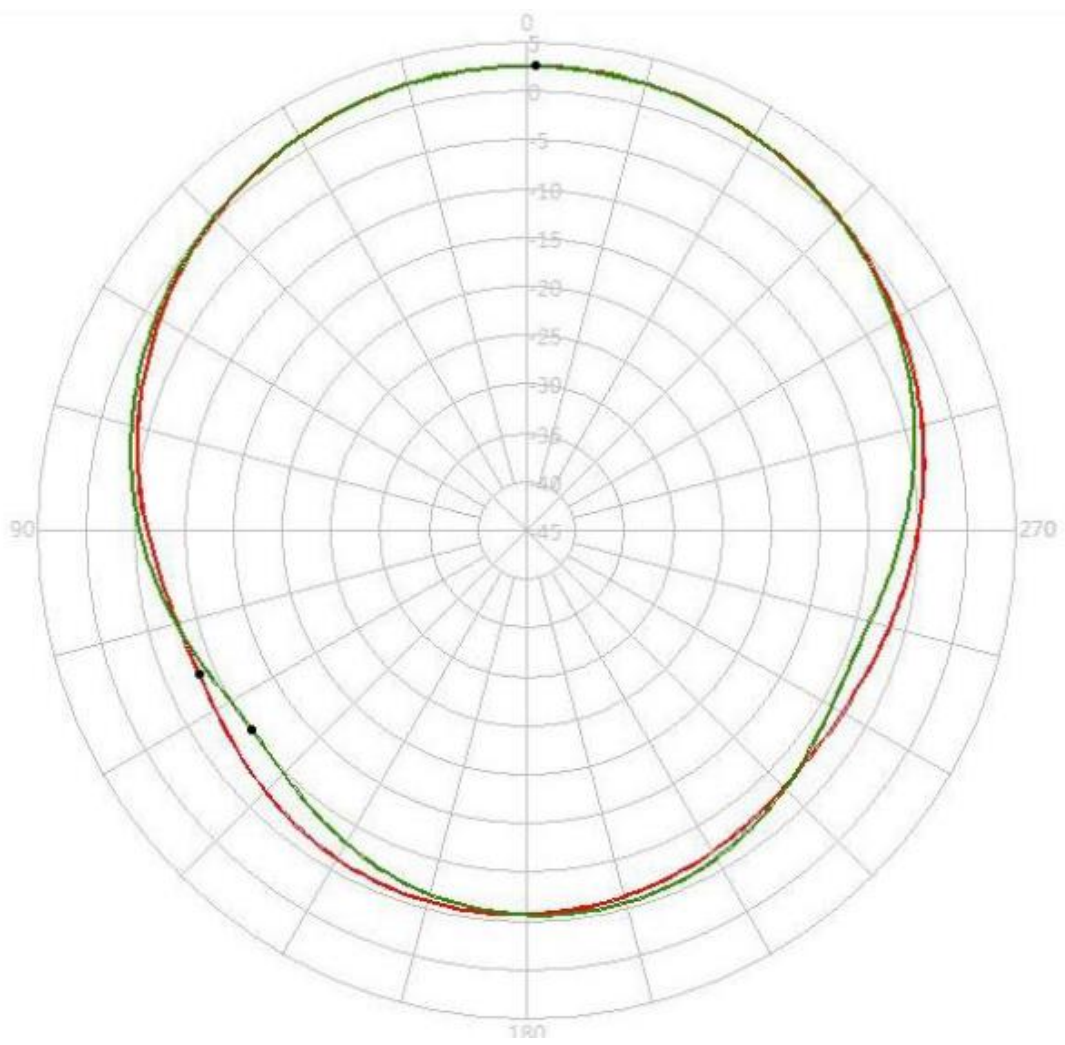

	Peak Gain (dBi)	Average Gain (dBi)
XZ Plane	2.57	-1.97
YZ Plane	2.56	-2.07

4.2 1561MHz Free Space

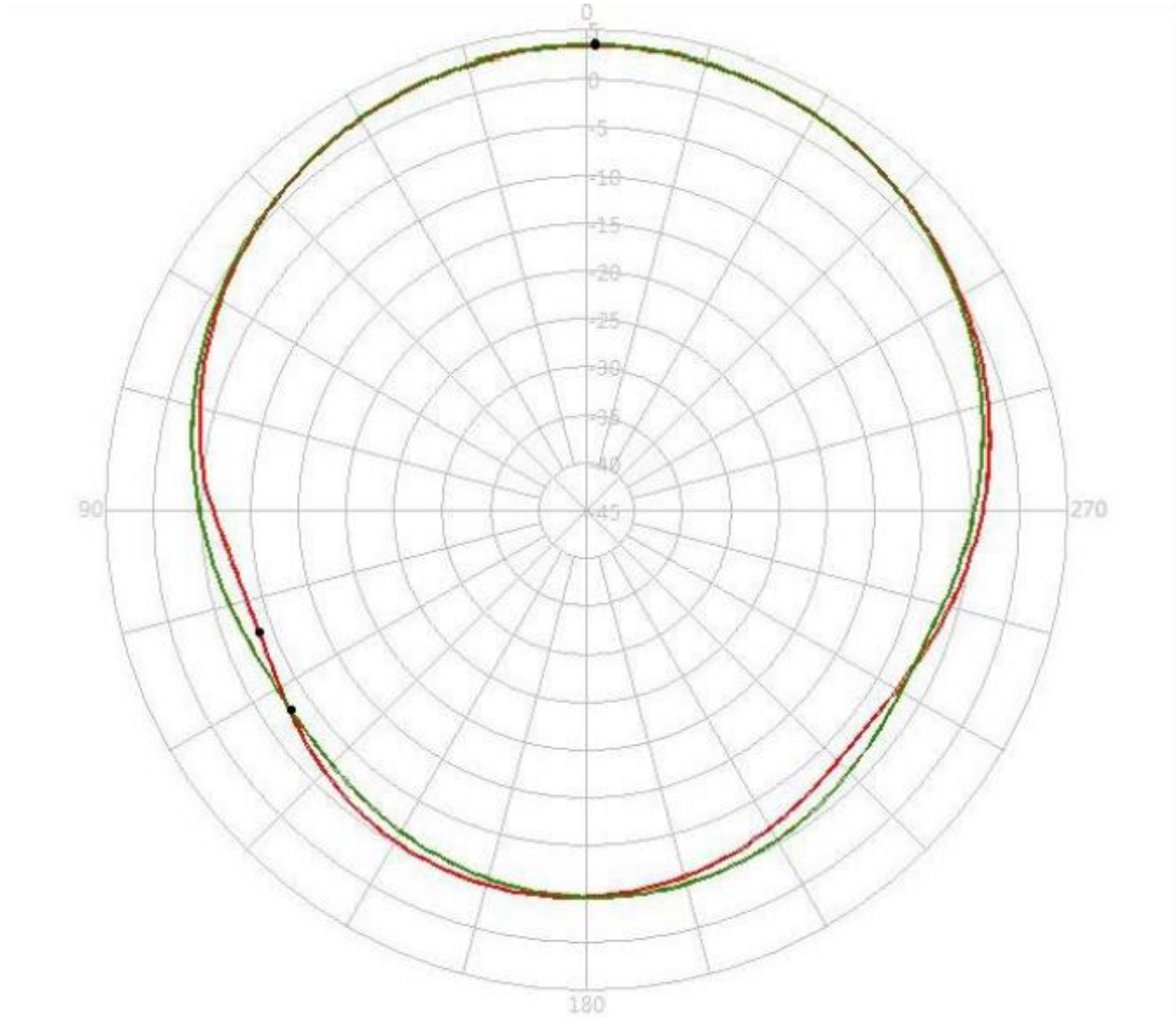

	Peak Gain (dBi)	Average Gain (dBi)
XZ Plane	3.32	-1.18
YZ Plane	3.45	-1.11

4.3 1602MHz Free Space

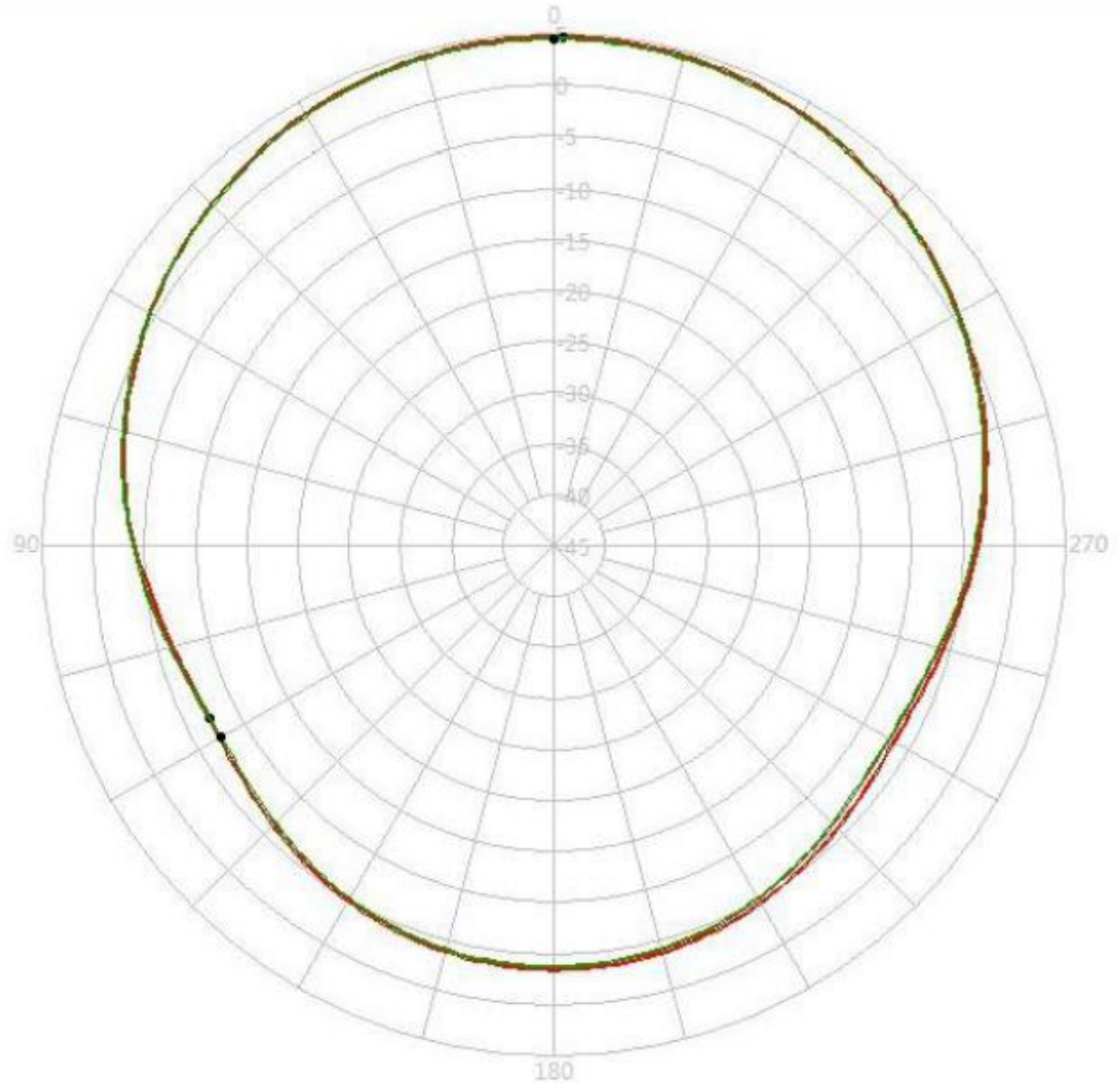

	Peak Gain (dBi)	Average Gain (dBi)
XZ Plane	4.72	0.08
YZ Plance	4.52	-0.08

5. Mechanical Drawing

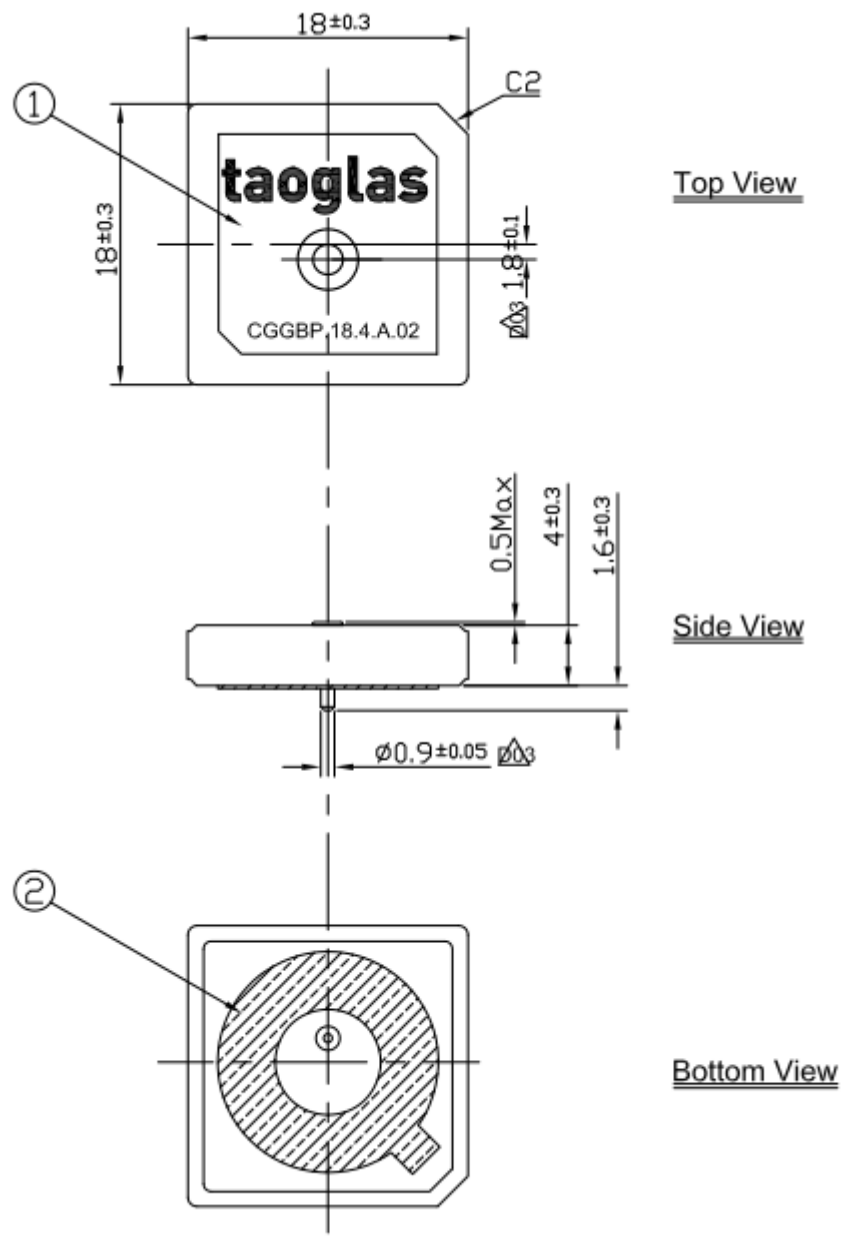

NOTES:
 1.Double sided adhesive area 

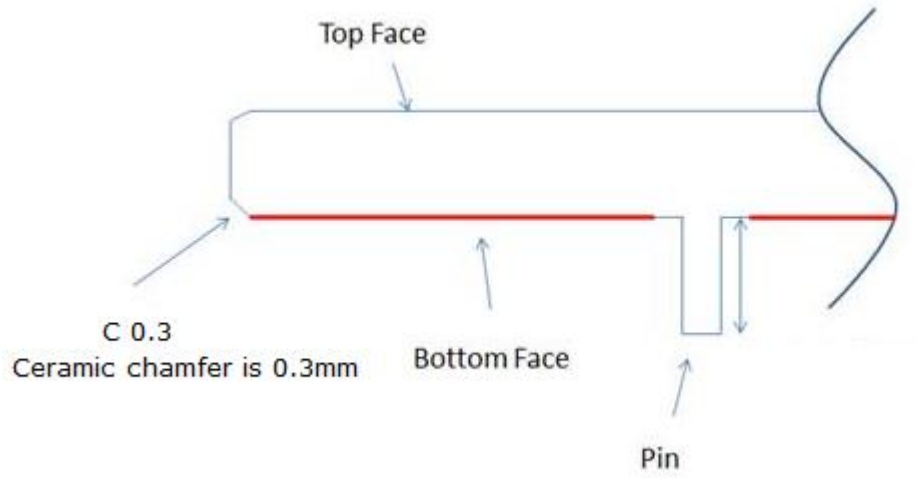

Red Line shows the adhesive without Liner – thickness 0.08~0.1mm

6. CGGBPD.18.A EVB

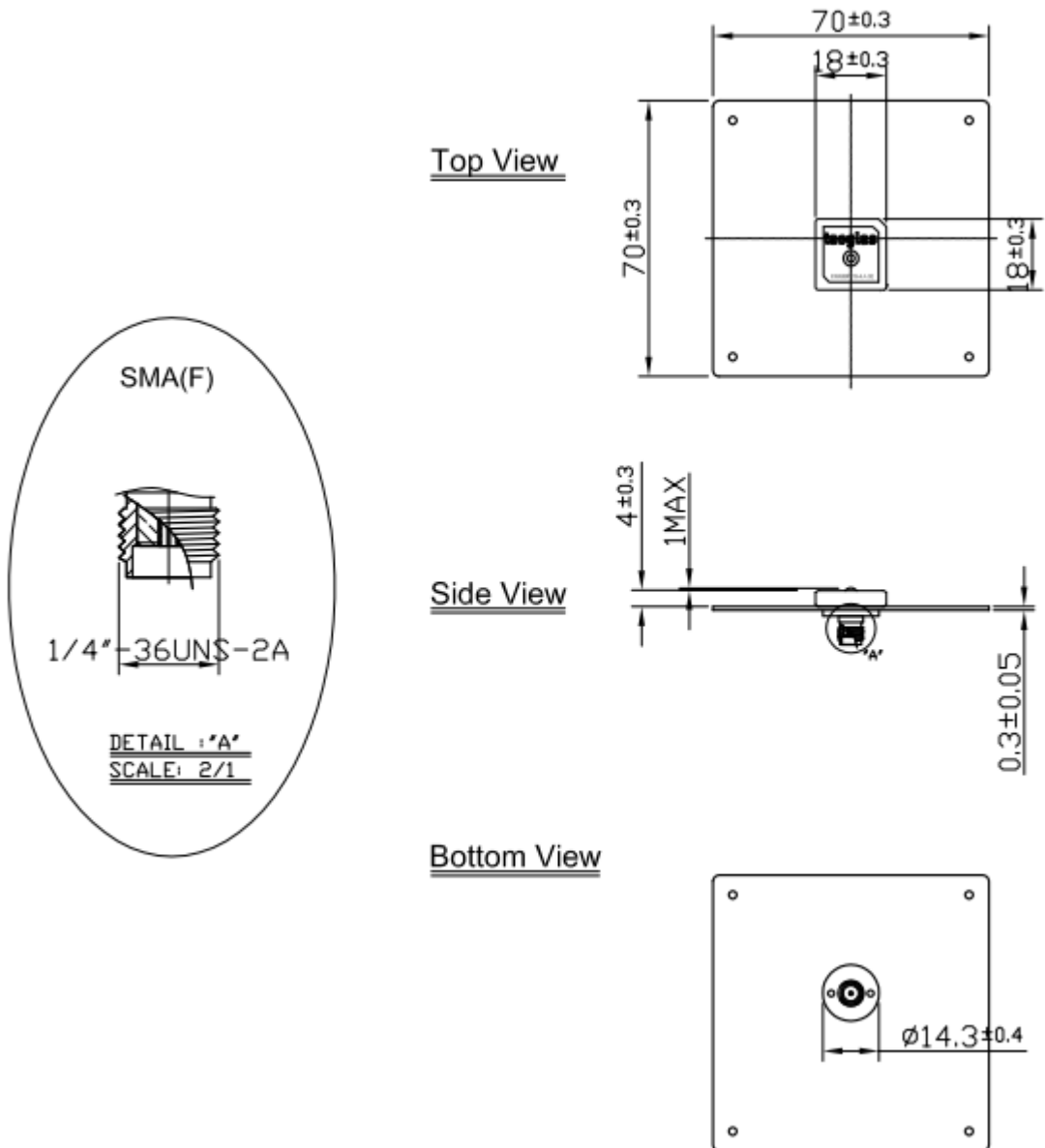

	Name	Material	Finish	QTY
1	Patch(18x18x4mm)	Ceramic	Clear	1
2	Ground-Plane(70x70x0.3mm)	Brass	Silver	1
3	SMA(F) ST	Brass	Gold	1



CGGBP.18.4.A.02 Patch on 70*70mm Ground Plane

7. PCB Footprint Recommendation

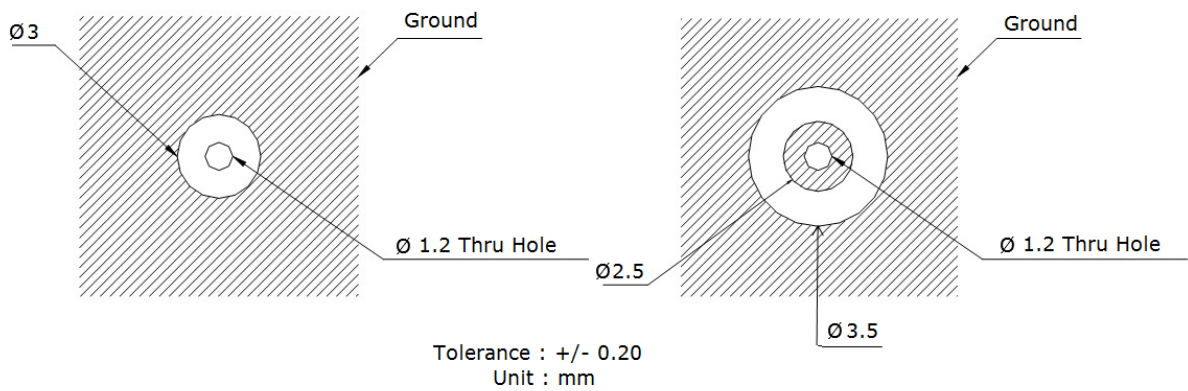

8. Packaging

8.1 Inner Tray

Per Tray: 25 pieces

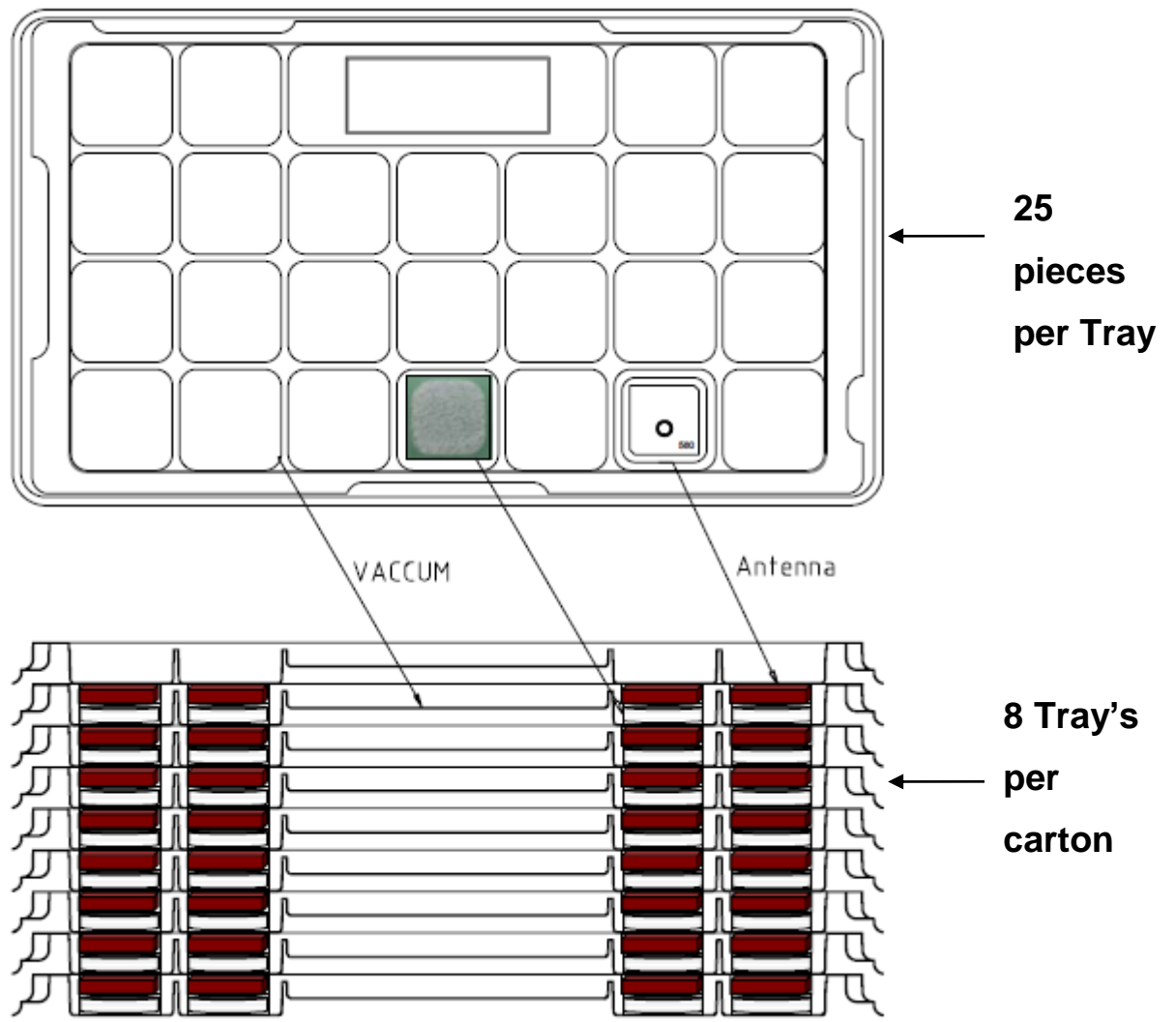

8.2 Carton

Per Carton(Inside Box) – 8 Trays = 200 pieces

Outer Carton (Outside Box)– 4 Cartons = 800 pieces

