

2.5V-3.3V Low-Skew 1-2 Differential PECL Fanout Buffer

FEATURES

- Two differential 2.5V/3.3V LVPECL output pairs.
- Output Frequency: ≤ 1 GHz.
- Translates any standard single-ended or differential input format to LVPECL output. It can accept the following standard input formats and more:
 - LVPECL, LVCMOS, LVDS, HCSL, SSTL, LVHSTL, CML.
- Output Skew: 25ps (typ.).
- Part-to-part skew: 140ps (typ.).
- Propagation delay: 1.5ns (typ.).
- Additive Jitter: <100 fs (typ.).
- Operating Supply Voltage: 2.375V ~ 3.63V.
- Operating temperature range from -40°C to 85°C.
- Package availability: SOP-8L and TSSOP-8L.

DESCRIPTION

The PL138-28 is a high performance low-cost 1: 2 outputs Differential PECL fanout buffer.

The family of Differential LVPECL buffers are designed to operate from a single power supply of $2.5V \pm 5\%$ or $3.3V \pm 10\%$. The differential input pair is designed to accept most standard input signal levels, using an appropriate resistor bias network, and produce a high quality set of outputs with the lowest possible skew on the outputs, which is guaranteed for part-to-part or lot-to lot skew.

Designed to fit in a small form-factor package, PL138 family offers up to 1GHz of output operation with very low-power consumption, and lowest additive jitter of any comparable device. The Output Enable feature, when activated, allows the IC to consume less than $10\mu A$ of current.

BLOCK DIAGRAM

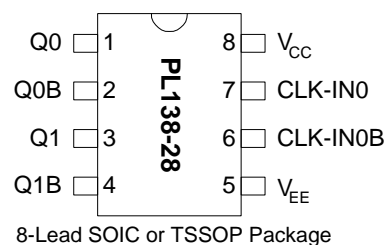
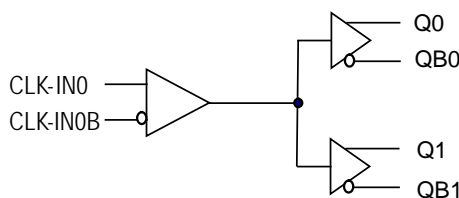

PIN DESCRIPTIONS

Name	Package Pin #	Type	Description
	SOIC-8L / TSSOP-8L		
Q0 ~ Q1	1, 3	O	LVPECL True output
QB0 ~ QB1	2, 4	O	LVPECL Complementary output
V _{EE}	5	P	Power Supply pin connection
CLK-IN0B	6	I	Complementary part of differential clock input signal
CLK-IN0	7	I	True part of differential clock input signal
V _{CC}	8	P	Power Supply pin connection

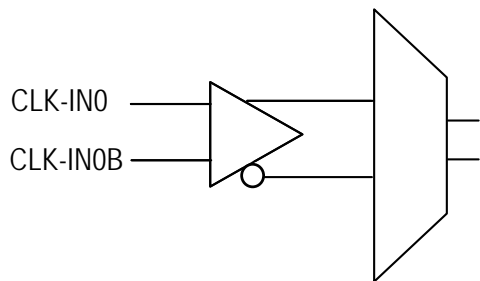
INPUT LOGIC BLOCK DIAGRAM

2.5V-3.3V Low-Skew 1-2 Differential PECL Fanout Buffer
ELECTRICAL SPECIFICATIONS
Absolute Maximum Ratings

PARAMETERS	SYMBOL	MIN.	MAX.	UNITS
Supply Voltage	V_{DD}		4.6	V
Input Voltage, dc	V_I	-0.5	$V_{DD}+0.5$	V
Output Voltage, dc	V_O	-0.5	$V_{DD}+0.5$	V
Storage Temperature	T_S	-65	150	°C
Ambient Operating Temperature*	T_A	-40	85	°C
Junction Temperature	T_J		110	°C
Lead Temperature (soldering, 10s)			260	°C
ESD Protection, Human Body Model	2			kV

Exposure of the device under conditions beyond the limits specified by Maximum Ratings for extended periods may cause permanent damage to the device and affect product reliability. These conditions represent a stress rating only, and functional operations of the device at these or any other conditions above the operational limits noted in this specification is not implied.

* Note: Operating Temperature is guaranteed by design for all parts (COMMERCIAL and INDUSTRIAL), but tested for COMMERCIAL grade only.

DC CHARACTERISTICS, $V_{CC} = 3.3V$; $V_{EE} = 0V$

Parameter	Symbol	-40°C			25°C			80°C			Units
		Min	Typ	Max	Min	Typ	Max	Min	Typ	Max	
Output High Voltage*	V_{OH}	2.215	2.320	2.420	2.275	2.350	2.420	2.275	2.35	2.420	V
Output Low Voltage*	V_{OL}	1.470	1.610	1.745	1.490	1.585	1.680	1.490	1.585	1.680	V
Input High Voltage	V_{IH}	2.075		2.420	2.135		2.420	2.135		2.420	V
Input Low Voltage	V_{IL}	1.470		1.890	1.490		1.825	1.490		1.825	V
Peak-to-Peak Input Voltage	V_{PP}	150	800	1200	150	800	1200	150	800	1200	V
Input High Voltage Common Mode Range ^{† †}	V_{CMR}	1.2		3.3	1.2		3.3	1.2		3.3	V
Input High Current	CLK-IN0, CLK-IN1	I_{IH}		75			75			75	μA
Input Low Current		I_{IL}	-75			-75			-75		

Input and output parameters vary 1:1 with V_{CC} . V_{EE} can vary +0.925V to -0.5V.

* Outputs terminated with 50Ω to V_{CC} - 2V.

** Single-ended input operation is limited. $V_{CC} \geq 3V$ in LVPECL mode.

† Common mode voltage is defined as V_{IH} .

†† For single-ended applications, the maximum input voltage for CLK-INx, CLK-INxB is $V_{CC} + 0.3V$

2.5V-3.3V Low-Skew 1-2 Differential PECL Fanout Buffer
DC CHARACTERISTICS, V_{CC} = 2.5V; V_{EE} = 0V

Parameter	Symbol	-40°C			25°C			80°C			Units
		Min	Typ	Max	Min	Typ	Max	Min	Typ	Max	
Output High Voltage*	V _{OH}	1.415	1.520	1.620	1.475	1.550	1.620	1.475	1.55	1.620	V
Output Low Voltage*	V _{OL}	0.670	0.810	0.945	0.690	0.785	0.880	0.690	0.785	0.880	V
Input High Voltage	V _{IH}	1.275		1.620	1.335		1.620	1.335		1.620	V
Input Low Voltage	V _{IL}	0.670		1.090	0.690		1.025	0.690		1.025	V
Peak-to-Peak Input Voltage	V _{PP}	150	800	1200	150	800	1200	150	800	1200	V
Input High Voltage Common Mode Range†	V _{CMR}	1.2		2.5	1.2		2.5	1.2		2.5	V
Input High Current	CLK-IN0, CLK-IN1	I _{IH}		60			60			60	μA
Input Low Current		I _{IL}	-60			-60			-60		

Input and output parameters vary 1:1 with V_{CC}. V_{EE} can vary +0.925V to -0.5V.

* Outputs terminated with 50Ω to V_{CC0} - 2V.

** Common mode voltage is defined as V_{IH}.

† For single-ended applications, the maximum input voltage for CLK-INx, CLK-INxB is V_{CC} + 0.3V

AC Electrical Characteristics

V_{CC} = -3.8V to -2.375V or, V_{CC} = 2.375V to 3.8V; V_{EE} = 0V, T_A = -40°C to 85°C

Parameter	Symbol	-40°C			25°C			80°C			Units	
		Min	Typ	Max	Min	Typ	Max	Min	Typ	Max		
Output Frequency	f _{MAX}			700			700			700	MHz	
Propagation Delay*	t _{PD}	600	680	750	650	725	790	690	790	890	ps	
Output Skew ** †	tsk(o)		25	37		25	37		25	37	ps	
Part-to-Part Skew *** †	tsk(pp)		85	225		85	225		85	225	ps	
Buffer Additive Phase Jitter, RMS; refer to Additive Phase Jitter Section	t _{APJ}		0.10			0.10			0.10		ps	
Output Rise/Fall Time	20% to 80%	t _R / t _F	200		700	200		700	200		700	ps

All parameters are measured at f ≤ 1000MHz, unless otherwise noted.

* Measured from the differential input crossing point to the differential output crossing point.

** Defined as skew between outputs at the same supply voltage and with equal load conditions. Measured at the output differential cross points.

*** Defined as skew between outputs on different devices operating at the same supply voltages and with equal load conditions. Using the same type of inputs on each device, the outputs are measured at the differential cross points.

† This parameter is defined in accordance with JEDEC Standard 65.

2.5V-3.3V Low-Skew 1-2 Differential PECL Fanout Buffer

NOISE CHARACTERISTICS (Commercial and Industrial Temperature Devices)

Parameter	Description	Test Conditions	Min.	Typ.	Max.	Unit
t _{APJ}	Additive Phase Jitter	V _{DD} =3.3V, Frequency=622.08MHz Offset=12KHz ~ 20MHz		21		fs

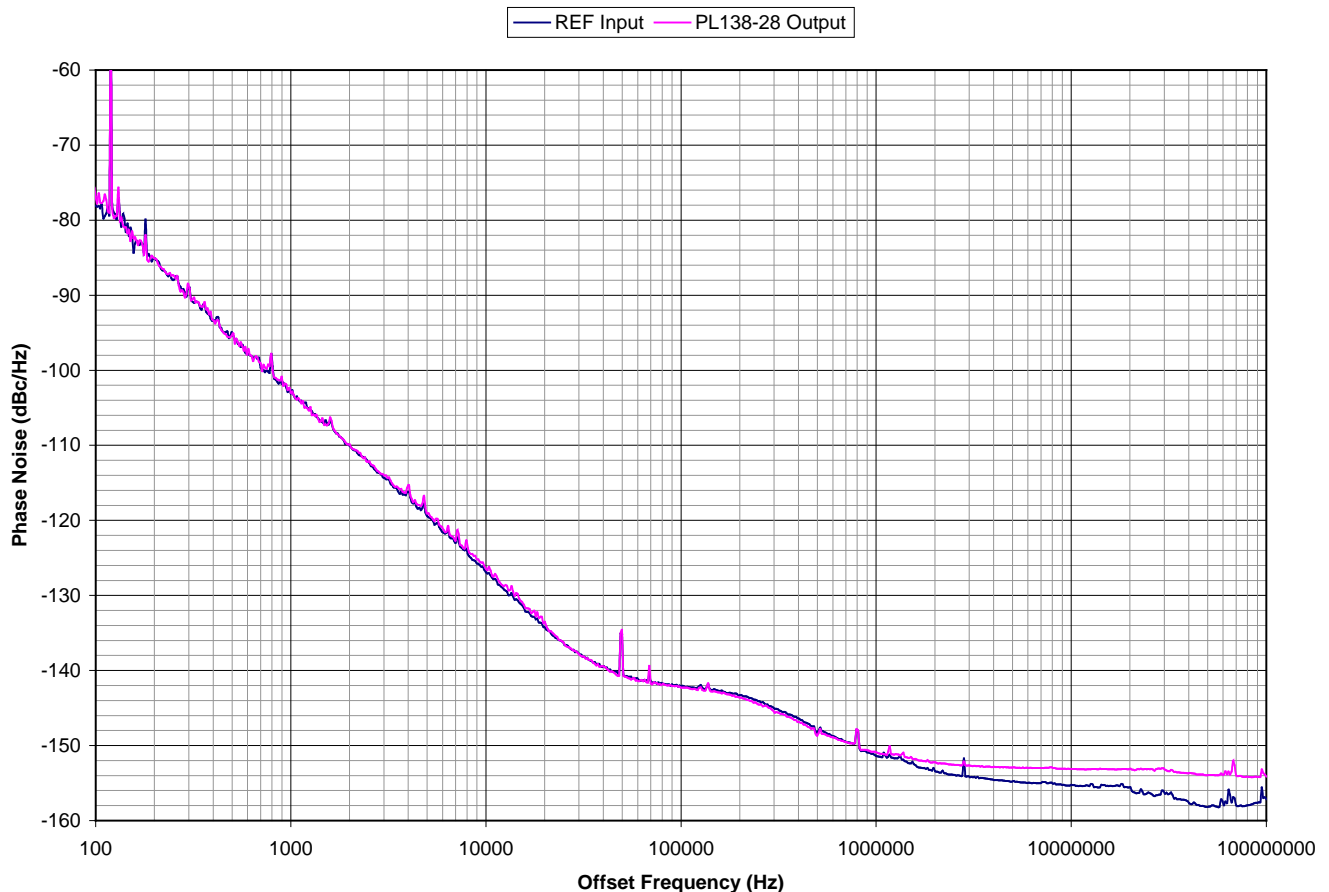

When a buffer is used to pass a signal then the buffer will add a little bit of its own noise. The phase noise on the output of the buffer will be a little bit more than the phase noise in the input signal. To quantify the noise addition in the buffer we compare the Phase Jitter numbers from the input and the output. The difference is called "Additive Phase Jitter". The formula for the Additive Phase Jitter is as follows:

$$\text{Additive Phase Jitter} = \sqrt{(\text{Output Phase Jitter})^2 - (\text{Input Phase Jitter})^2}$$

2.5V-3.3V Low-Skew 1-2 Differential PECL Fanout Buffer

PARAMETER MEASUREMENT INFORMATION

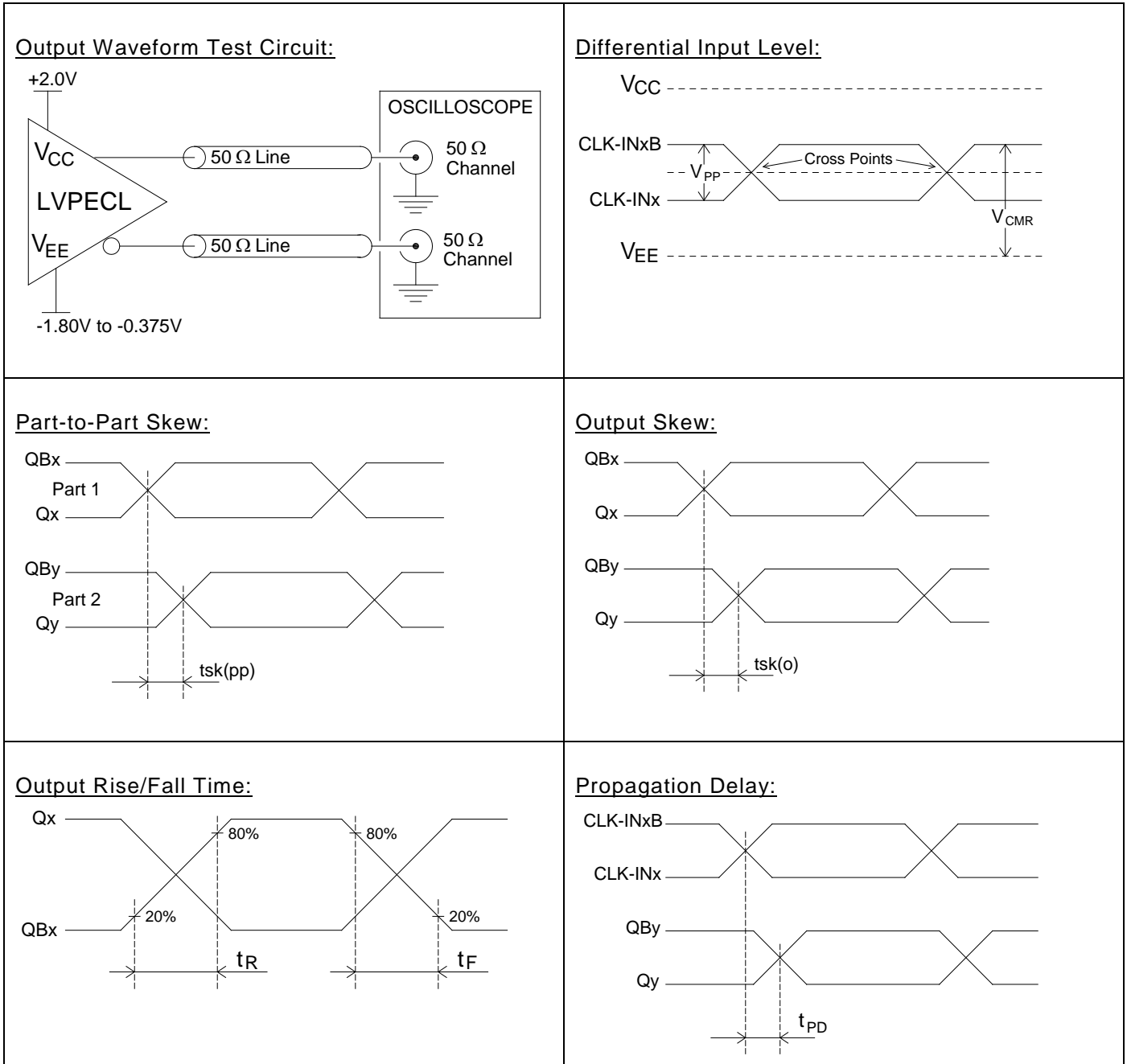

2.5V-3.3V Low-Skew 1-2 Differential PECL Fanout Buffer

APPLICATION INFORMATION

The following circuits show different configurations for different input logic type signals. For good signal integrity at the PL138 input, the signals need to be properly terminated according to the logic type requirements. The signals need to be presented at the PL138 input according to V_{CMR} , V_{PP} and other input requirements.

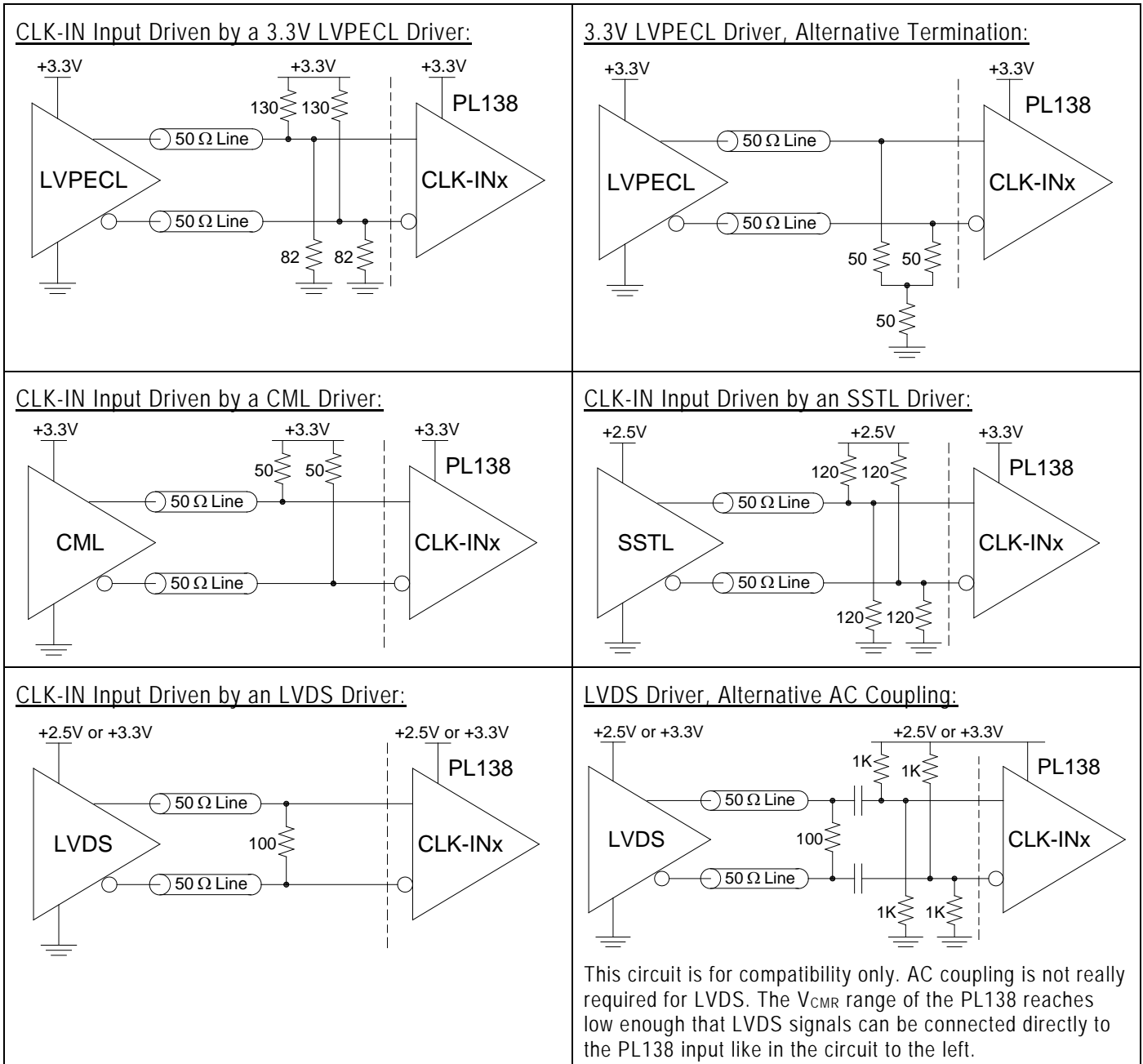

2.5V-3.3V Low-Skew 1-2 Differential PECL Fanout Buffer

<p><u>CLK-IN Input Driven by a CMOS Driver:</u></p>	<p><u>CLK-IN Input Driven by Single Ended LVPECL:</u></p>
<p><u>CLK-IN Input Driven by an HCSL Driver:</u></p>	<p>HCSL presents its signals very close to the ground rail, below the V_{CMR} range, so the HCSL signals can not be connected to the PL138 input directly. AC coupling is required for HCSL signals on the PL138 input.</p>

TERMINATION FOR LVPECL OUTPUTS

The required termination for LVPECL is 50Ω to a $V_{CC}-2V$ DC voltage level. Below are two schematics to implement this termination.

<p><u>LVPECL Termination Schematic #1:</u></p>	<p><u>LVPECL Termination Schematic #2:</u></p>
<p>$V_{CC}=3.3V$, Ideal values: $R1=127\Omega$, $R2=82.5\Omega$ Commercial values (E24): $R1=130\Omega$, $R2=82\Omega$ $V_{CC}=2.5V$, Ideal values: $R1=250\Omega$, $R2=62.5\Omega$ Commercial values (E24): $R1=240\Omega$, $R2=62\Omega$</p>	<p>Schematic #2 is an alternative simplified termination. $V_{CC}=3.3V$, Ideal value: $RT=48.7\Omega$ Commercial value: $RT=50\Omega$ (E24: 51Ω) $V_{CC}=2.5V$, Ideal value: $RT=18.7\Omega$ Commercial value: $RT=18\Omega$</p>

2.5V-3.3V Low-Skew 1-2 Differential PECL Fanout Buffer

POWER CONSIDERATIONS

Driving LVPECL outputs requires an amount of power that can warm up the chip significantly.

The general requirement for the chip is that the junction temperature should not exceed +110°C.

The power consumption can be divided into two parts:

- 1) Core power dissipation
- 2) Output buffers power dissipation

CORE POWER DISSIPATION

The chip core power is equal to $VCC \times IEE$. With a worst case VCC and IEE the power dissipation in the core is $3.63V \times 45mA = 163mW$.

OUTPUT BUFFER POWER DISSIPATION

The output buffers are not exposed to the full VCC-VEE voltage. On the differential output, one line is at logic 1 with a small voltage across the buffer and a large output current. The other line is at logic 0 with a larger voltage across the buffer and a smaller output current. The power dissipation per output buffer is 32mW. Only buffers that are loaded will have power dissipation. With both buffers loaded the worst case output buffer power dissipation will be 64mW.

Total Chip Power Dissipation, worst case, is $163mW + 64mW = 227mW$.

JUNCTION TEMPERATURE

How much the chip is warmed up from the power dissipation depends upon the thermal resistance from the chip to the environment, also known as "junction to ambient". The thermal resistance depends upon the type of package, how the package is assembled to the PCB and if there is additional air flow for improved cooling. For the LQFP package with use of the Thermal Relief pad, the thermal resistance is as follows:

JEDEC Standard Multi Layer PCB	Air Flow Velocity in Linear Feet per Minute		
	0	200	500
SOIC 8-pin Package	$\theta_{JA} = 97^{\circ}C/W$	$\theta_{JA} = 85^{\circ}C/W$	$\theta_{JA} = 77^{\circ}C/W$
TSSOP 8-pin Package	$\theta_{JA} = 120^{\circ}C/W$	$\theta_{JA} = 105^{\circ}C/W$	$\theta_{JA} = 95^{\circ}C/W$

SOIC 8-pin:

The temperature of the chip (junction) will be higher than the environment (ambient) with an amount equal to $\theta_{JA} \times$ Power. For an ambient temperature of +85°C, all outputs loaded and no air flow, the junction temperature $T_J = 85^{\circ}C + 97 \times 0.227 = 107^{\circ}C$.

TSSOP 8-pin:

For an ambient temperature of +85°C, all outputs loaded and 200LFM air flow, the junction temperature $T_J = 85^{\circ}C + 105 \times 0.227 = 109^{\circ}C$. It is recommended to use at least 200LFM air flow to prevent the junction temperature from increasing above +110°C.

For use up to +80°C or lower no air flow is needed: $T_J = 80^{\circ}C + 120 \times 0.227 = 107^{\circ}C$.

PACKAGE DRAWINGS (GREEN PACKAGE COMPLIANT)

8 Pin (dimensions in mm)

Symbol	SOIC		TSSOP	
	Min.	Max.	Min.	Max.
A	1.35	1.75	-	1.20
A1	0.10	0.25	0.05	0.15
A2	1.25	1.50	-	1.05
B	0.33	0.53	0.19	0.30
C	0.19	0.27	0.09	0.20
D	4.80	5.00	2.90	3.10
E	3.80	4.00	4.30	4.50
H	5.80	6.20	6.20	6.60
L	0.40	0.89	0.45	0.75
e	1.27 BSC		0.65 BSC	

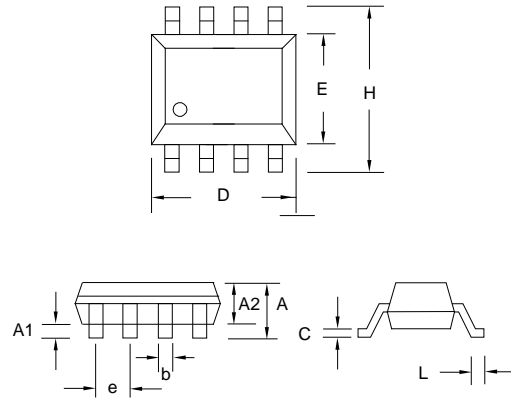

2.5V-3.3V Low-Skew 1-2 Differential PECL Fanout Buffer

ORDERING INFORMATION (GREEN PACKAGE)

For part ordering, please contact our Sales Department:

2180 Fortune Drive, San Jose, CA 95131, USA

Tel: (408) 944-0800 Fax: (408) 474-1000

PART NUMBER

The order number for this device is a combination of the following:
Part number, Package type and Operating temperature range

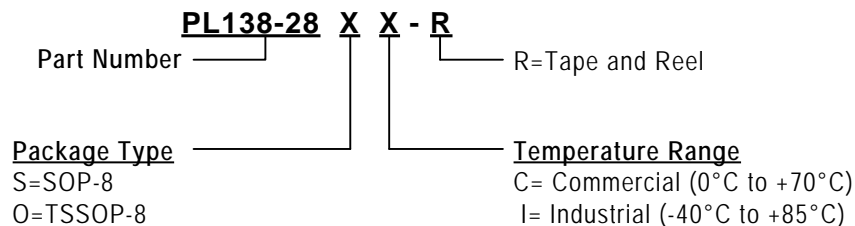

Part/Order Number	Marking	Package Option
PL138-28SC-R	P138-28 SC LLLLL	8-Pin SOP (Tape and Reel)
PL138-28OC-R	P138-28 OC LLLLL	8-Pin TSSOP (Tape and Reel)

*Note: LLLLL designates lot number

Micrel Inc., reserves the right to make changes in its products or specifications, or both at any time without notice. The information furnished by Micrel is believed to be accurate and reliable. However, Micrel makes no guarantee or warranty concerning the accuracy of said information and shall not be responsible for any loss or damage of whatever nature resulting from the use of, or reliance upon this product.

LIFE SUPPORT POLICY: *Micrel's products are not authorized for use as critical components in life support devices or systems without the express written approval of the President of Micrel Inc.*