

**Proven
Reliability**

A SERIES

ISOLATED, PROPORTIONAL DC TO HV DC CONVERTERS

100V to 6000V @ 1.0 and 1.5 Watts

**Extremely Low Profile: 0.25 inches
and volume of < 0.100 cubic inches⁵**

**NOW
UL RECOGNIZED**



PRODUCT DESCRIPTION

The A Series is a new line of ultra-miniature, DC to HV DC converters that set an industry standard in high voltage miniaturization. This unique package occupies less than one tenth of a cubic inch of volume⁵, and features an extremely low profile of only 0.250 inches (6.35mm)! Controllable output voltages range from 100 volts to 6000 volts. These component-sized converters are ideal for applications requiring minimal size and weight. Please refer to our AG series data sheet for surface mount options.

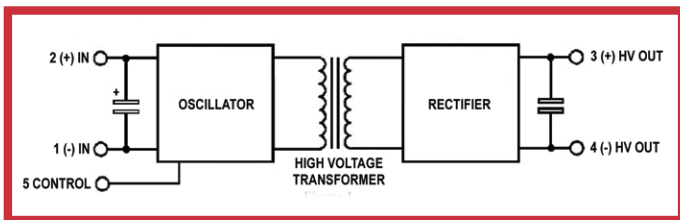

APPLICATIONS

- Avalanche Photodiodes
- Capacitor Charging
- Electrophoresis
- Photomultiplier Tubes
- Piezo Devices
- Mass Spectrometry
- Sustaining Ion Pumps

OPTIONS

- 1 Watt and 1.5 Watt Versions Available (A/AH)
- Three Input Voltage Ranges: 0 to 5, 12, or 24VDC (5V only above 3KV)
- Polarity: Choose Positive or Negative Output (P/N)
- Extended Operating Temperature (A Models / 1.0W) (T Suffix)
- Alternate Input / Output Voltages (Consult Factory)
- See Ordering Information (Page 11)

PRODUCT SELECTION TABLE

VDC	STANDARD 1 WATT - A MODEL		1.5 WATT OPTION - AH MODEL	
	MODEL	MAXIMUM OUTPUT CURRENT*1	MODEL	MAXIMUM OUTPUT CURRENT*1
100 VDC	A01	10 mA	AH01	15 mA
200 VDC	A02	5 mA	AH02	7.5 mA
250 VDC	A025	4 mA	AH025	6 mA
300 VDC	A03	3.33 mA	AH03	5mA
400 VDC	A04	2.5 mA	AH04	3.75 mA
500 VDC	A05	2 mA	AH05	3 mA
600 VDC	A06	1.67 mA	AH06	2.5 mA
700 VDC	A07	1.43 mA	AH07	2.15 mA
800 VDC	A08	1.25 mA	AH08	1.87 mA
900 VDC	A09	1.1 mA	AH09	1.67 mA
1000 VDC	A10	1 mA	AH10	1.5 mA
1200 VDC	A12	0.83 mA	AH12	1.25 mA
1500 VDC	A15	0.66 mA	AH15	1 mA
2000 VDC	A20	0.5 mA	AH20	0.75 mA
3000 VDC	A30	0.32 mA	AH30	0.5 mA
4000 VDC	A40	0.24 mA	-	-
5000 VDC	A50	0.2 mA	-	-
6000 VDC	A60	0.167 mA	AH60	0.25 mA

Complete List of Models on page 2

FEATURES

- Proportional Input/Output
- Low Noise Quasi-sinewave Oscillator
- Control Pin
- Low Leakage Current
- Low Input/Output Capacitance
- Input to Output Galvanic Isolation
- Short Circuit Protection, 1 Minute Minimum
- No Minimum Load Required²
- MTBF > 1,862,000 hours, per Bellcore TR 332
- No External Components Required
- RoHS Compliant
- UL Recognized



ELECTRICAL SPECIFICATIONS*3

OUTPUT VOLTAGE*2 (To select polarity, see pg. 10 - How to Order)	STANDARD 1 WATT - A MODEL			1.5 WATT OPTION - AH MODEL		
	MODEL	MAXIMUM OUTPUT CURRENT*1	RIPPLE P-P*4	MODEL	MAXIMUM OUTPUT CURRENT*1	RIPPLE P-P*4
0 to 100 VDC	A01	10 mA	5%	AH01	15 mA	2%
0 to 200 VDC	A02	5 mA	1%	AH02	7.5 mA	3%
0 to 250 VDC	A025	4 mA	.90%	AH025	6 mA	1.2%
0 to 300 VDC	A03	3.33 mA	.70%	AH03	5 mA	.70%
0 to 400 VDC	A04	2.5mA	.50%	AH04	3.75 mA	.75%
0 to 500 VDC	A05	2 mA	.50%	AH05	3 mA	.70%
0 to 600 VDC	A06	1.67 mA	1%	AH06	2.5 mA	2%
0 to 700 VDC	A07	1.43 mA	.50%	AH07	2.15 mA	1.2%
0 to 800 VDC	A08	1.25 mA	1%	AH08	1.87 mA	1.2%
0 to 900 VDC	A09	1.1 mA	1%	AH09	1.67 mA	1.2%
0 to 1000 VDC	A10	1 mA	.79%	AH10	1.5 mA	1%
0 to 1200 VDC	A12	0.83 mA	.50%	AH12	1.25 mA	.60%
0 to 1500 VDC	A15	0.67 mA	.40%	AH15	1 mA	.60%
0 to 2000 VDC	A20	0.5 mA	.30%	AH20	0.75 mA	.50%
0 to 3000 VDC	A30	0.33 mA	.20%	AH30	0.5 mA	.20%
0 to 4000 VDC	A40	0.25 mA	.12%	-	-	-
0 to 5000 VDC	A50	0.2 mA	.15%	-	-	-
0 to 6000 VDC	A60	0.167 mA	.15%	AH60	0.25 mA	.25%

	INPUT CURRENT			
	A MODELS – 1 Watt		AH MODELS – 1.5 Watt	
VIN	NO-LOAD	FULL-LOAD	NO-LOAD	FULL-LOAD
5 VDC	<300mA	<500mA	<300mA	<550mA
12 VDC	<100mA	<185mA	<125mA	<250mA
24 VDC	<25mA	<60mA	<40mA	<120mA

0 TO 5V ONLY (FOR MODELS OVER 3kV)

ELECTRICAL SPECIFICATIONS*3

PARAMETER	VALUE
INPUT VOLTAGE	0 TO 5, 12, OR 24V (FOR MODELS UP TO 3KV)
	0 TO 5V (FOR MODELS OVER 3KV)
TURN-ON VOLTAGE	<0.7 VDC
ISOLATION	< +/- 500V BIAS ON PIN 4
OUTPUT VOLTAGE TOLERANCE	+10%, -10% FULL LOAD, MAX. INPUT VOLTAGE
INPUT/OUTPUT COUPLING CAPACITANCE	<250 pf TYPICAL
INPUT/OUTPUT LEAKAGE CURRENT	<100 nA TYPICAL
CONTROL PIN	0 to MAX. INPUT VOLTAGE
INTERNAL OSCILLATOR FREQUENCY	50kHz - 350kHz
STANDARD TEMPERATURE RANGES	OPERATING: -25° TO +75°C ⁶ (CASE)
	STORAGE: -55° TO +105°C
EXTENDED TEMPERATURE RANGES (-T OPTION)	OPERATING: -55 TO +85°C ⁶ (CASE) [A Models / 1.0W]
	STORAGE: -55° TO +105°C

DETAILED PRODUCT DESCRIPTION

The A Series is a new line of ultra-miniature, DC to HV DC converters that set an industry standard in high voltage miniaturization. This unique package occupies less than one tenth of a cubic inch of volume⁵, and features an extremely low profile of only 0.250 inches (6.35mm)! Controllable output voltages range from 100 volts to 6000 volts. These component-sized converters are ideal for applications requiring minimal size and weight.

Turn-on voltage is very low at less than 0.7 volts, allowing for wide output voltage operating range. Use of a resonant, quasi-sinewave oscillator and fully shielded transformer result in clean, reliable high voltage conversion with inherently low ripple, EMI/RFI and input ripple current, making this product ideal for integration into noise sensitive equipment.

A separate high impedance control pin is standard and is designed for external error amplifier and/or DAC control in closed or open loop systems.

Or simply connect the control pin to the + input for proportional input to output operation (see schematic and performance charts below).

Output power is 1 watt standard, with 1.5 watts available as an option. No minimum load is required. A proprietary vacuum encapsulation process and custom 94V-0 listed, high performance formula are used to achieve excellent high voltage and thermal properties. Isolation is +/- 500V bias on the output return. Input to output leakage current is very low at less than 100 nA and coupling capacitance is also low at <250 pF.

The new A Series leverages XP EMCO's Best-in-Class long term reliability, utilizing proven DC to high voltage DC conversion technology, perfected by over four decades of high voltage design experience in the most demanding applications. Our extensive in-house capabilities enable us to meet specific customer requirements with standard, modified and custom solutions quickly, easily, and economically. Technical assistance is readily available.

MECHANICAL SPECIFICATIONS (100V - 2,000V)

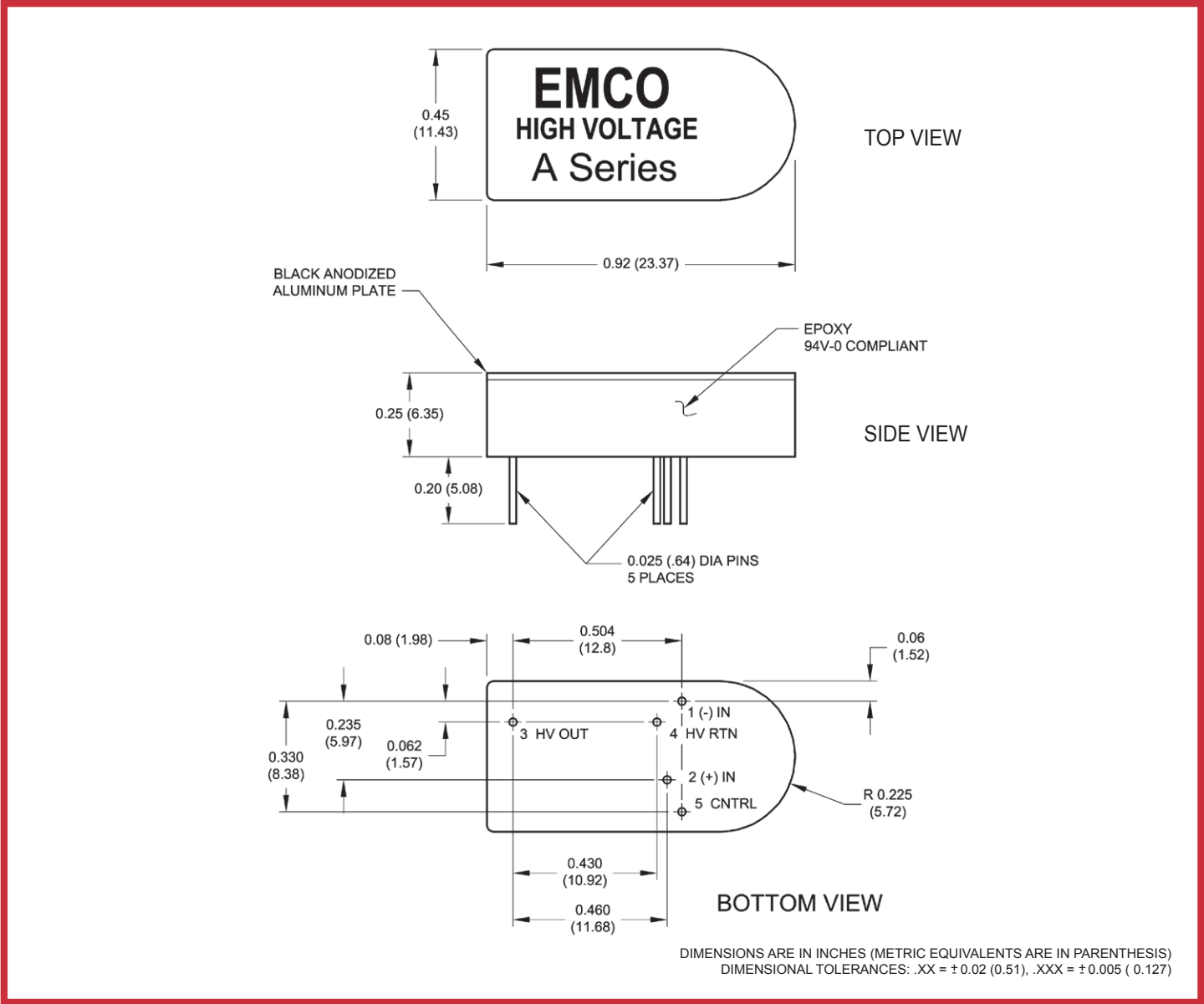

PARAMETER	VALUE
WEIGHT	< 0.20 OZ. (5.66 GRAMS)
VOLUME	< 0.10 CUBIC INCHES (1.696 CUBIC CENTIMETERS)
DIMENSIONS	0.92L (23.37L) x 0.45W (11.43W) x 0.25H (6.35H)

PIN #	FUNCTION
1	(-) INPUT
2	(+) INPUT
3	HV OUT
4	HV RTN
5	CONTROL

MECHANICAL SPECIFICATIONS (3,000V - 5,000V)

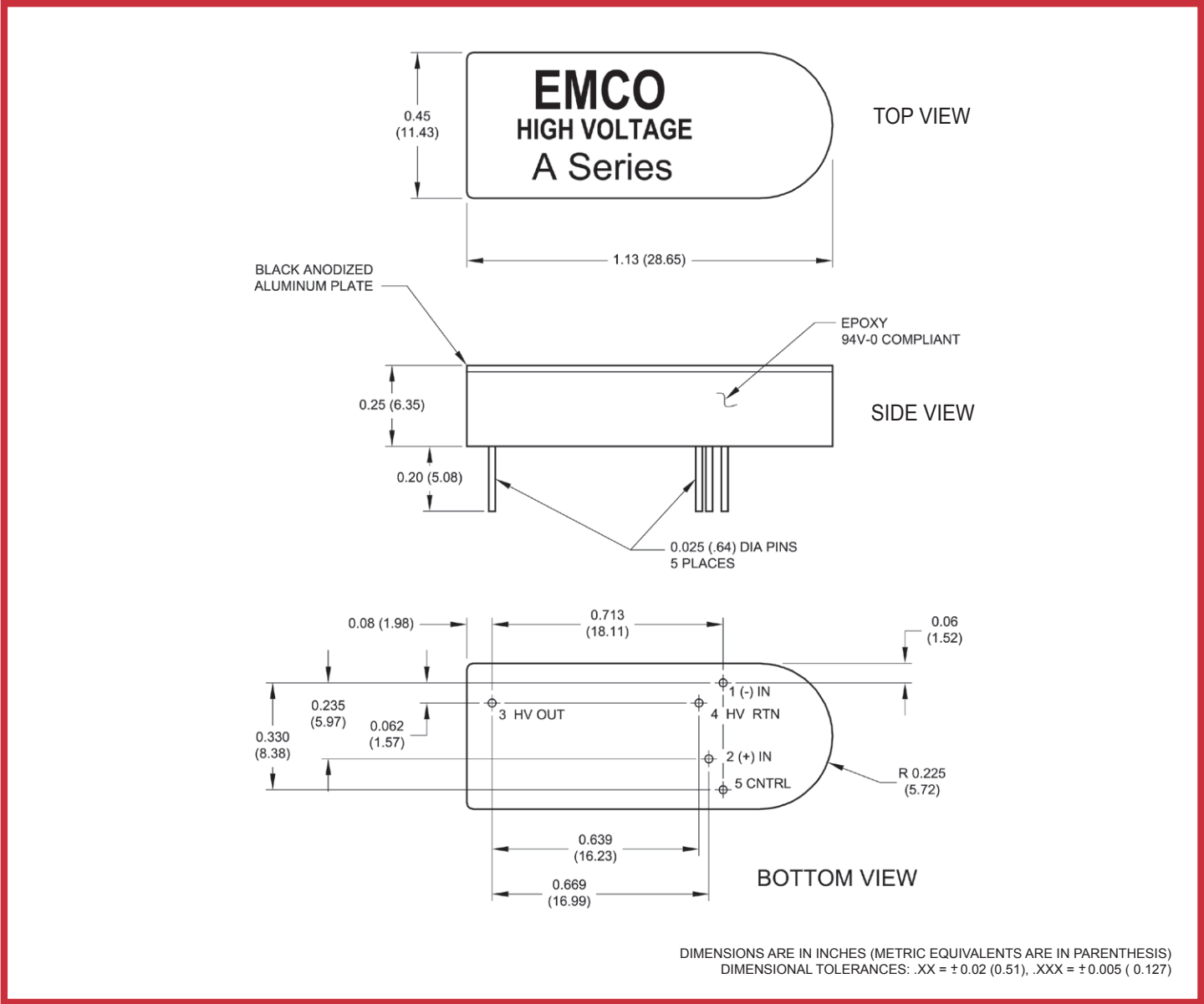

PARAMETER	VALUE
WEIGHT	< 0.25OZ (7.09 GRAMS)
VOLUME	< 0.12 CUBIC INCHES (2.082 CUBIC CENTIMETERS)
DIMENSIONS	1.129L (28.69L) x 0.45W (11.43W) x 0.25H (6.35H)

PIN #	FUNCTION
1	(-) INPUT
2	(+) INPUT
3	HV OUT
4	HV RTN
5	CONTROL

MECHANICAL SPECIFICATIONS (6,000V)

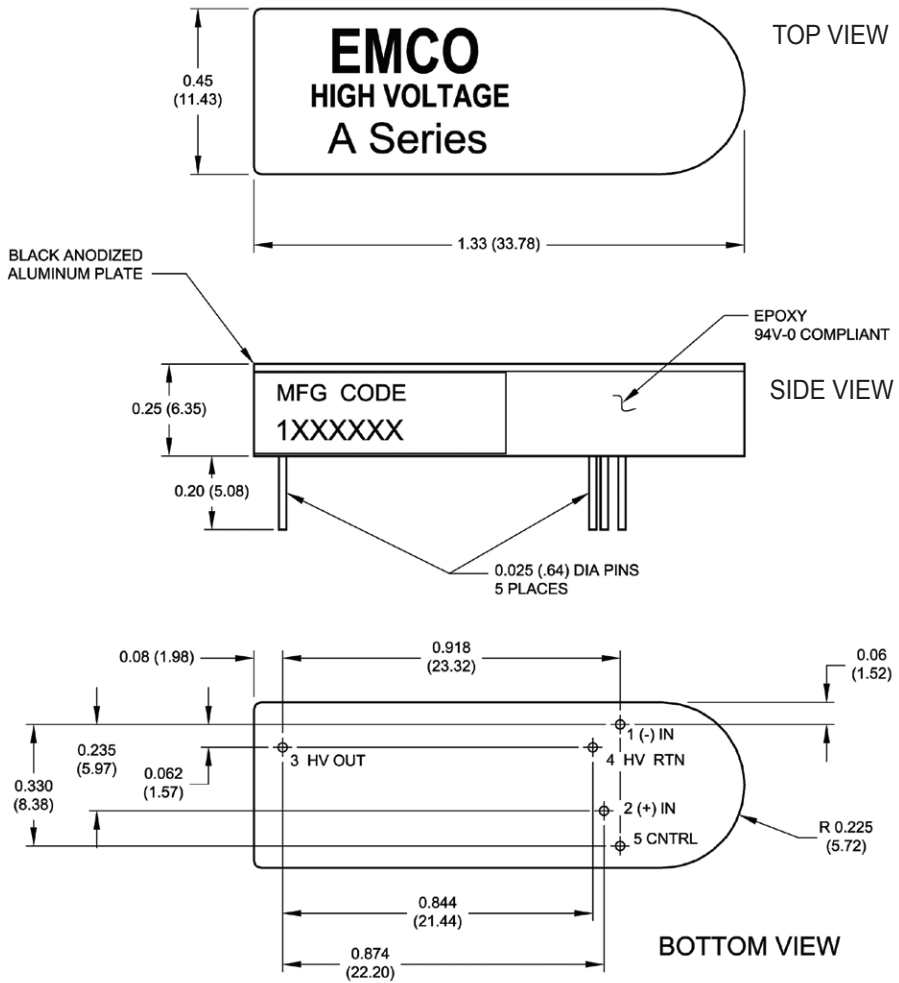

DIMENSIONS ARE IN INCHES (METRIC EQUIVALENTS ARE IN PARENTHESIS)
 DIMENSIONAL TOLERANCES: .XX = ± 0.02 (0.51), .XXX = ± 0.005 (0.127)

PARAMETER	VALUE
WEIGHT	< 0.30 OZ. (8.49 GRAMS)
VOLUME	< 0.15 CUBIC INCHES (2.45 CUBIC CENTIMETERS)
DIMENSIONS	1.33L (33.78L) x 0.45W (11.43W) x 0.25H (6.35H)

PIN #	FUNCTION
1	(-) INPUT
2	(+) INPUT
3	HV OUT
4	HV RTN
5	CONTROL

MECHANICAL SPECIFICATIONS

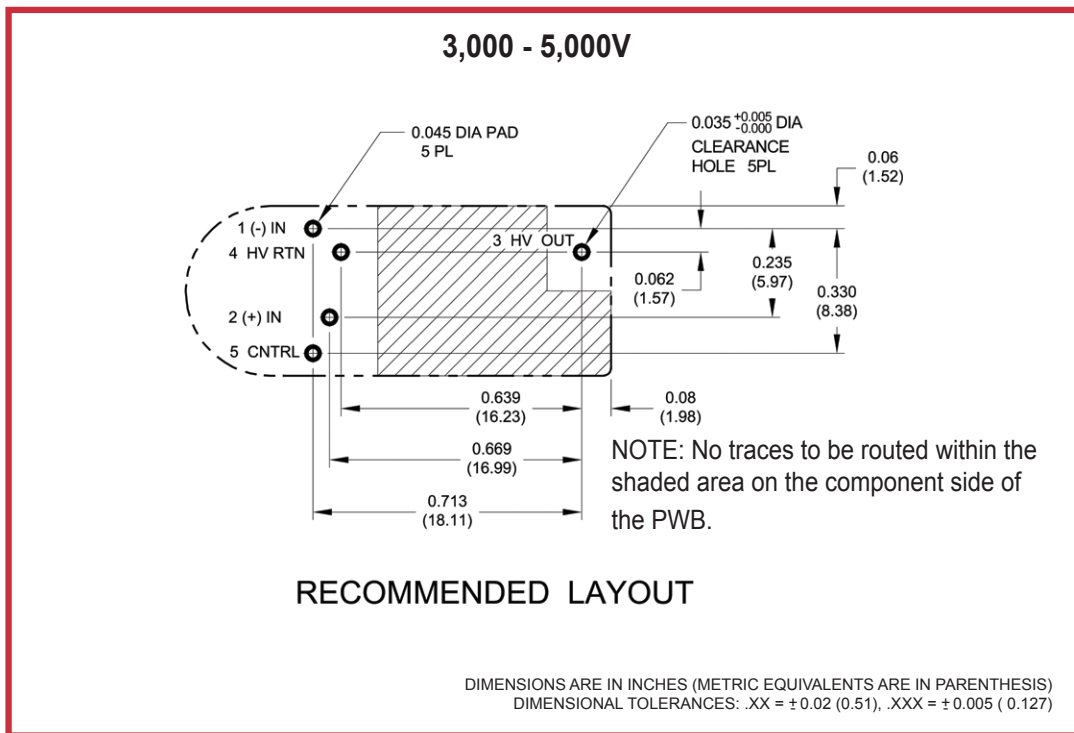
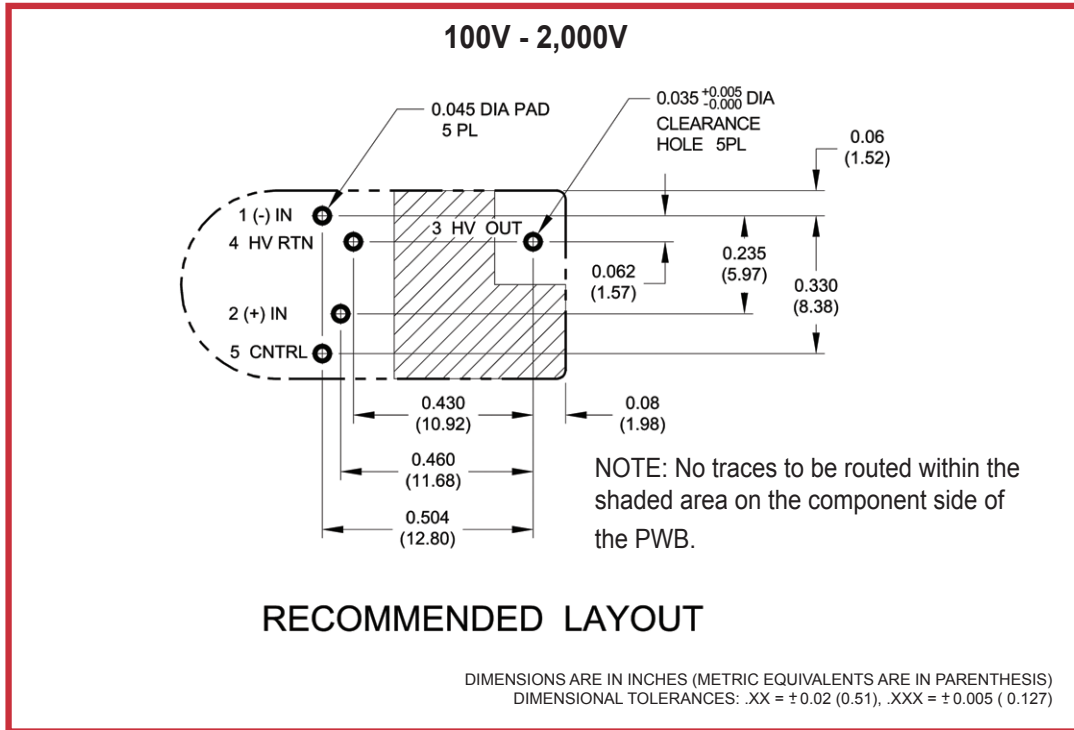

MECHANICAL SPECIFICATIONS

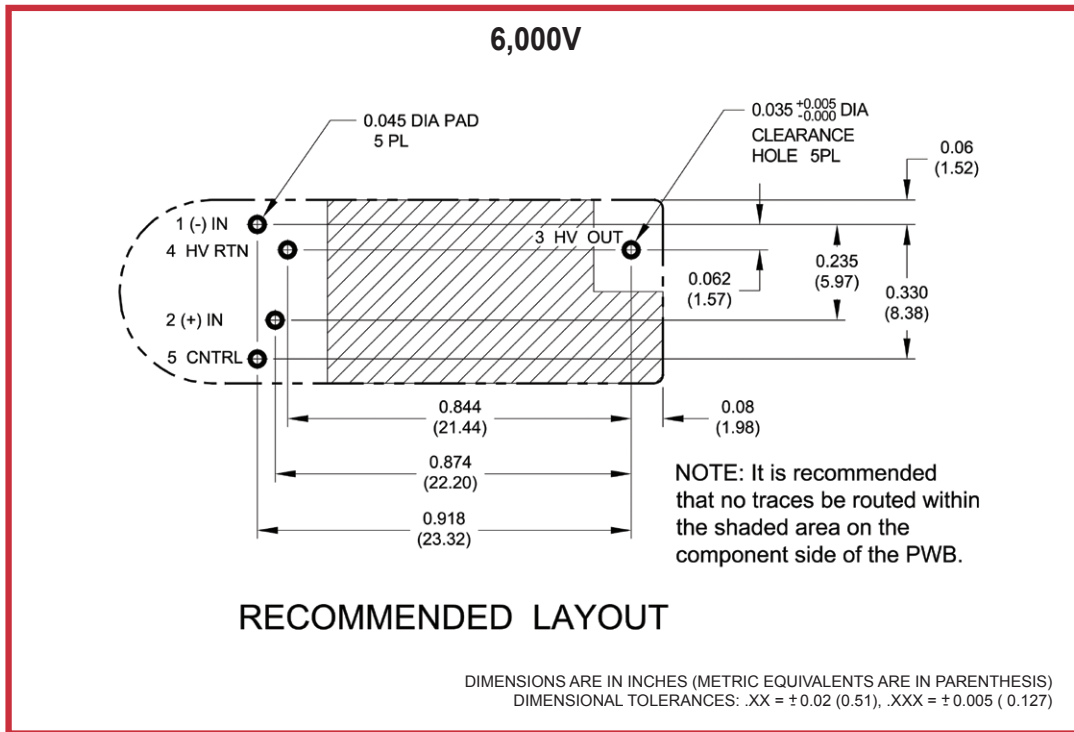

APPLICATION NOTES

Typical HV Output vs. Control Voltage

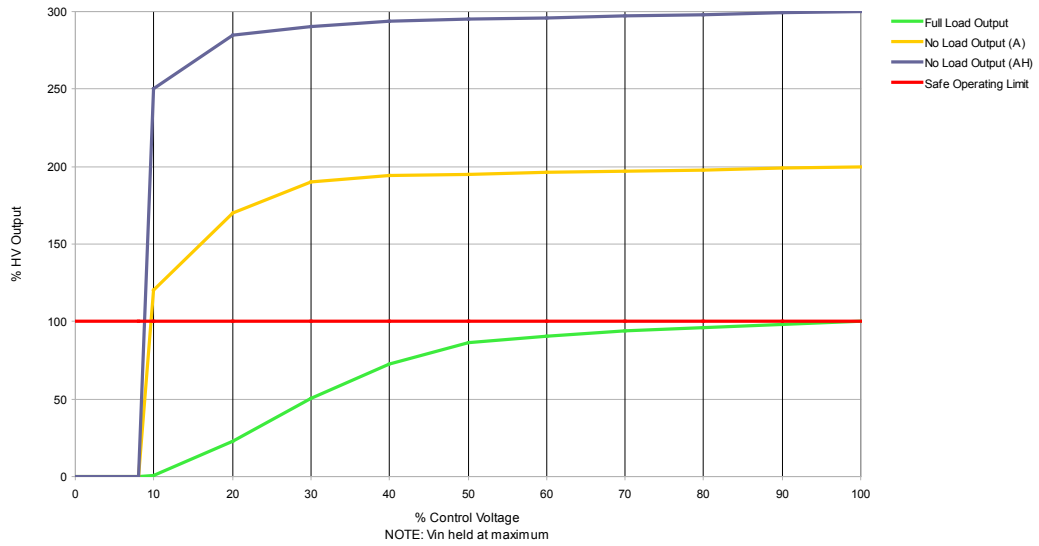

Typical Input vs. Output Voltage

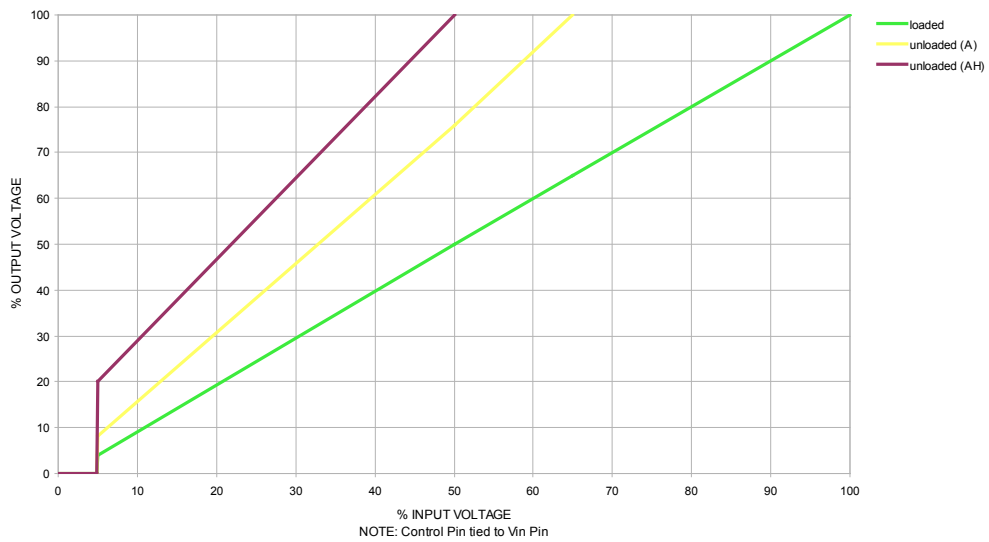

Output Voltage is load dependent. Under light or no-load conditions, reduce the Input Voltage so maximum rated Output Voltage is not exceeded.

OPTION CODES

ORDERING INFORMATION		ORDER CODE
OUTPUT VOLTAGE	1 WATT	A
	1.5 WATT	AH
POLARITY DESIGNATOR	POSITIVE OUTPUT	P
	NEGATIVE OUTPUT	N
INPUT VOLTAGE	5 VDC	5
	12 VDC	12
	24 VDC	24
STANDARD TEMPERATURE RANGES	OPERATING: -25 TO +75°C ⁶ (CASE)	BLANK
	STORAGE: -55 TO +105°C	BLANK
EXTENDED TEMPERATURE RANGES	OPERATING: -55 TO +85°C ⁶ (CASE) [A Models / 1.0W]	T
	STORAGE: -55 TO +105°C	T

HOW TO ORDER

PART NUMBER SELECTOR:

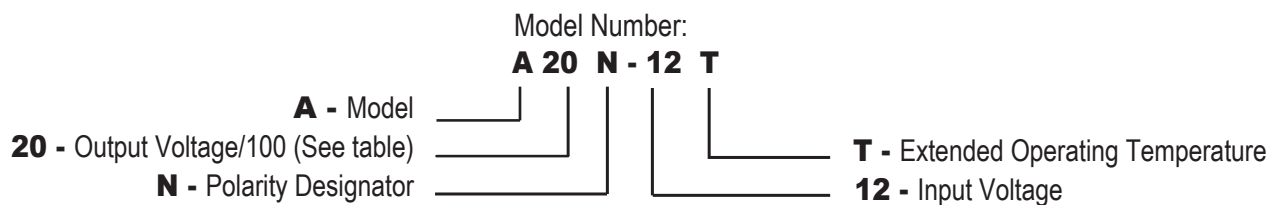

EXAMPLE: **A20N-12T** (**A** - Model, **20** - Output Voltage, **N** - Negative, **12** - Input Voltage, **T** - Extended Operating Temperature)

- *Note:
1. At maximum rated output voltage
 2. Output Voltage is load dependent. Under light or no-load conditions, reduce the Input Voltage so maximum rated Output Voltage is not exceeded.
 3. Specifications after 30 minute warm-up, full-load, at 25°C, unless otherwise noted.
 4. Ripple may be reduced substantially by the addition of an external RC filter.
 5. Volume will vary depending on package size.
 6. Proper thermal management techniques are required to maintain safe case temperature at maximum power output.

XP EMCO reserves the right to make changes on products and literature, including specifications, without notice. XP EMCO standard product models are not recommended for "copy-exact" applications or any other application restricting product changes. "Copy-exact" options are available. Please contact an XP EMCO sales representative for more details.