

## Single Phase Rectifier Bridges

### PSB 62

$I_{dAVM}$   
 $V_{RRM}$

= 52 A  
= 800-1800 V

Preliminary Data Sheet

$V_{RSM}$ V	$V_{RRM}$ V	Type
800	800	PSB 62/08
1200	1200	PSB 62/12
1400	1400	PSB 62/14
1600	1600	PSB 62/16
1800	1800	PSB 62/18

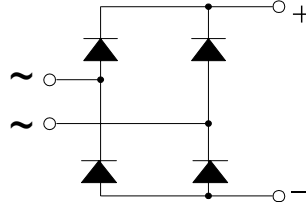

Symbol	Test Conditions	Maximum Ratings
$I_{dAVM}$	$T_C = 100^\circ\text{C}$ , module	52 A
$I_{FSM}$	$T_{VJ} = 45^\circ\text{C}$ $V_R = 0$ $t = 10\text{ ms}$ (50 Hz), sine	550 A
	$t = 8.3\text{ ms}$ (60 Hz), sine	600 A
	$T_{VJ} = T_{VJM}$ $V_R = 0$ $t = 10\text{ ms}$ (50 Hz), sine	500 A
	$t = 8.3\text{ ms}$ (60 Hz), sine	550 A
$\int i^2 dt$	$T_{VJ} = 45^\circ\text{C}$ $V_R = 0$ $t = 10\text{ ms}$ (50 Hz), sine	1520 $\text{A}^2\text{ s}$
	$t = 8.3\text{ ms}$ (60 Hz), sine	1520 $\text{A}^2\text{ s}$
	$T_{VJ} = T_{VJM}$ $V_R = 0$ $t = 10\text{ ms}$ (50 Hz), sine	1250 $\text{A}^2\text{ s}$
	$t = 8.3\text{ ms}$ (60 Hz), sine	1250 $\text{A}^2\text{ s}$
$T_{VJ}$		-40 ... + 150 $^\circ\text{C}$
$T_{VJM}$		150 $^\circ\text{C}$
$T_{stg}$		-40 ... + 125 $^\circ\text{C}$
$V_{ISOL}$	50/60 HZ, RMS $t = 1\text{ min}$	2500 V ~
	$I_{ISOL} \leq 1\text{ mA}$ $t = 1\text{ s}$	3000 V ~
$M_d$	Mounting torque (M5)	5 Nm
	Terminal connection torque (M5)	5 Nm
Weight	typ.	160 g

### Features

- Package with screw terminals
- Isolation voltage 3000 V~
- Planar glasspassivated chips
- Blocking voltage up to 1800 V
- Low forward voltage drop
- UL registered E 148688

### Applications

- Supplies for DC power equipment
- Input rectifiers for PWM inverter
- Battery DC power supplies
- Field supply for DC motors

### Advantages

- Easy to mount with two screws
- Space and weight savings
- Improved temperature and power cycling capability

### Package, style and outline

Dimensions in mm (1mm = 0.0394")

Symbol	Test Conditions	Characteristic Value
$I_R$	$V_R = V_{RRM}$ $T_{VJ} = 25^\circ\text{C}$	$\leq 0.3\text{ mA}$
	$V_R = V_{RRM}$ $T_{VJ} = T_{VJM}$	$\leq 5\text{ mA}$
$V_F$	$I_F = 150\text{ A}$ $T_{VJ} = 25^\circ\text{C}$	$\leq 1.8\text{ V}$
$V_{TO}$	For power-loss calculations only	0.8 V
$r_T$	$T_{VJ} = T_{VJM}$	8 $\text{m}\Omega$
$R_{thJC}$	per diode; DC current	1.45 K/W
	per module	0.36 K/W
$R_{thJK}$	per diode; DC current	1.87 K/W
	per module	0.47 K/W
$d_S$	Creeping distance on surface	10 mm
$d_A$	Creeping distance in air	9.4 mm
$a$	Max. allowable acceleration	50 $\text{m/s}^2$

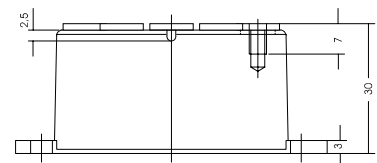
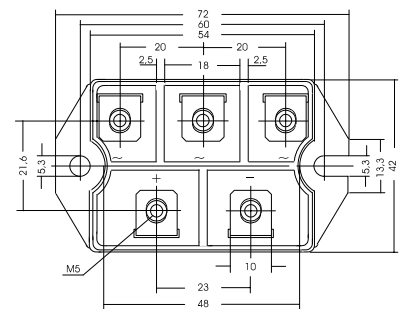

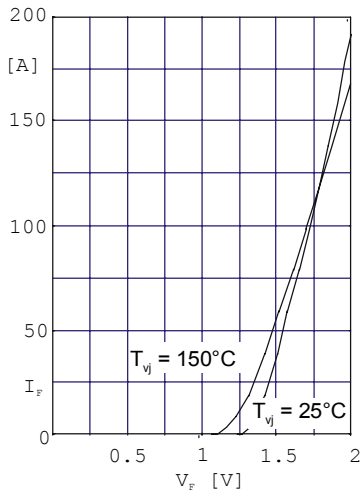

Fig. 1 Forward current versus voltage drop per diode

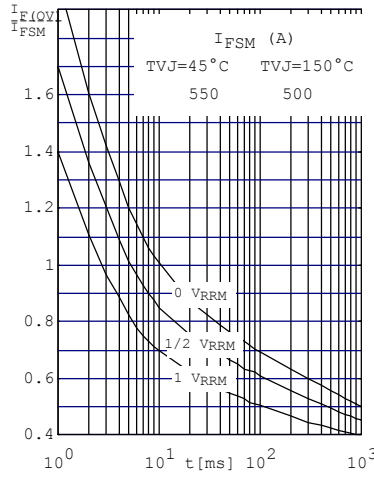

Fig. 2 Surge overload current per diode  $I_{FSM}$ : Crest value.  $t$ : duration

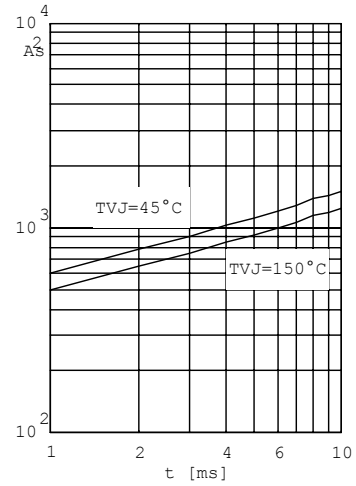

Fig. 3  $\int i^2 dt$  versus time (1-10ms) per diode (or thyristor)

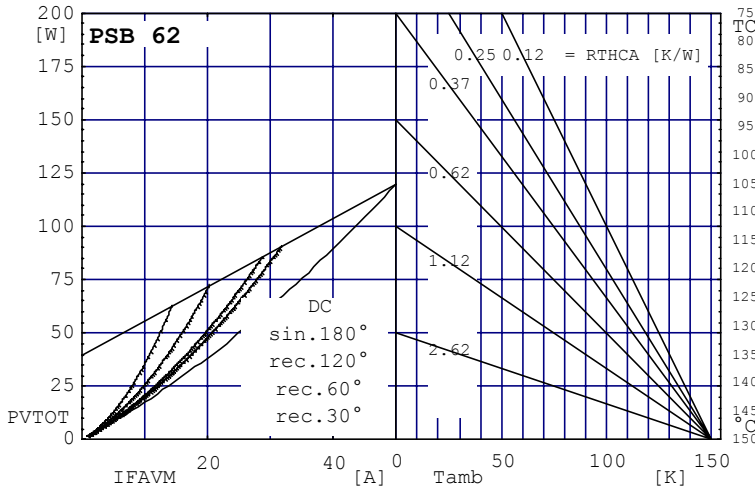

Fig. 4 Power dissipation versus direct output current and ambient temperature

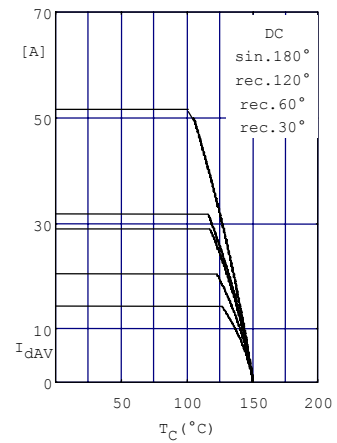

Fig.5 Maximum forward current at case temperature

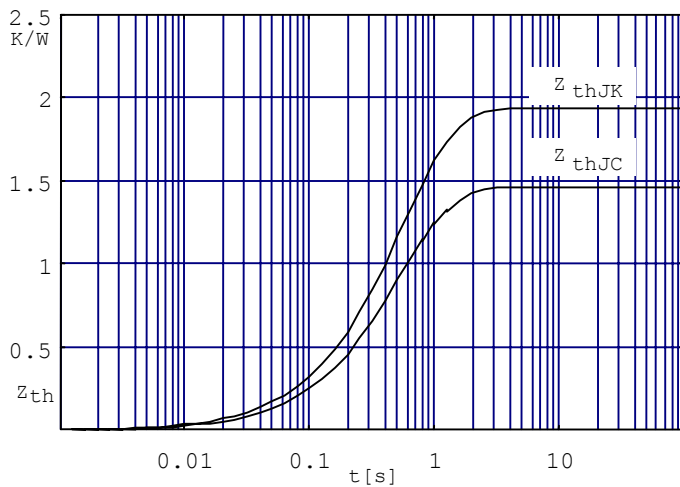

Fig. 6 Transient thermal impedance per diode (or thyristor), calculated