

Stacked Metallized PEN Film Chip Capacitor

Type : **ECWU(C)**

Stacked metallized PEN film as dielectric with simple mold-less construction

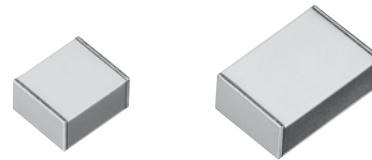

Features

- Small in size
- For reflow soldering
- RoHS directive compliant

Recommended applications

- General purpose (Coupling, By-pass)

Explanation of part number

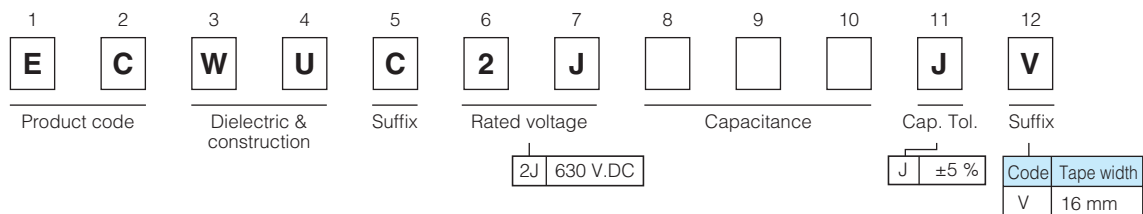
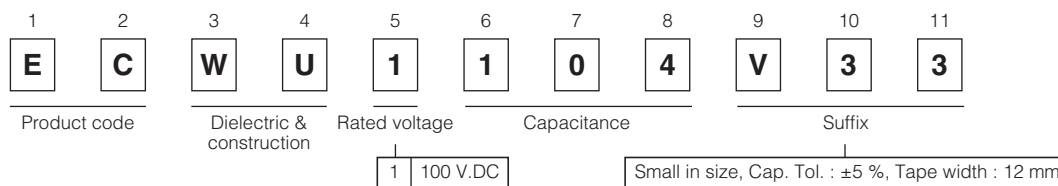
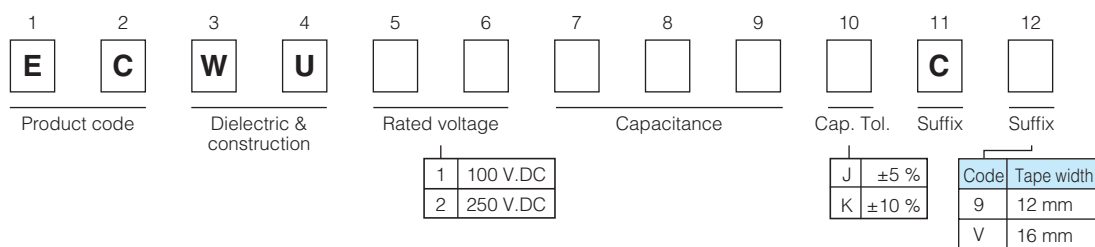

Specifications

Category temp. range (Including temperature-rise on unit surface)	- 55 °C to +125 °C	
Rated voltage	100 V.DC, 250 V.DC, 630 V.DC (Derating of rated voltage by 1.25 %/°C more than 85 °C)	
Capacitance range	100 V.DC	0.012 μF to 1.0 μF (E12)
	250 V.DC	0.0010 μF to 0.12 μF (E12)
	630 V.DC	0.022 μF, 0.027 μF, 0.033 μF
Capacitance tolerance	100 V.DC	±5 % (J), ±10 % (K) (C ≥ 0.18 μF : ±10 % (K) Only)
	250 V.DC	±5 % (J), ±10 % (K)
	630 V.DC	±5 % (J)
Dissipation factor (tan δ)	tan δ ≤ 1.0 % (20 °C, 1 kHz)	
Withstand voltage	Between terminals : Rated volt. (V.DC) × 150 %, 60 s	
Insulation resistance (IR)	C ≤ 0.33 μF	100 V.DC, 250 V.DC, 630 V.DC : IR ≥ 3000 MΩ (20 °C, 100 V.DC, 60 s)
	C > 0.33 μF	100 V.DC : IR ≥ 1000 MΩ·μF (20 °C, 100 V.DC, 60 s)
Soldering conditions	100 V.DC	Reflow soldering : 250 °C max. and 60 s max. at more than 220 °C
	250 V.DC	(Temp. at capacitor surface)
	630 V.DC	Reflow soldering : 250 °C max. and 60 s to 150 s. at more than 217 °C (Temp. at cap. surface)

* In case of applying voltage in alternating current (50 Hz or 60 Hz sine wave) to a capacitor with DC rated voltage, please refer to the page of "Permissible voltage (R.M.S) in alternating current corresponding to DC rated voltage".

* Please consult us for capacitance range between 0.15 μF and 1.0 μF. (250 V.DC)

Construction

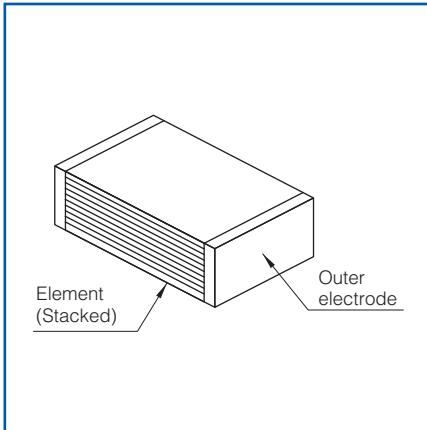

Dimensions

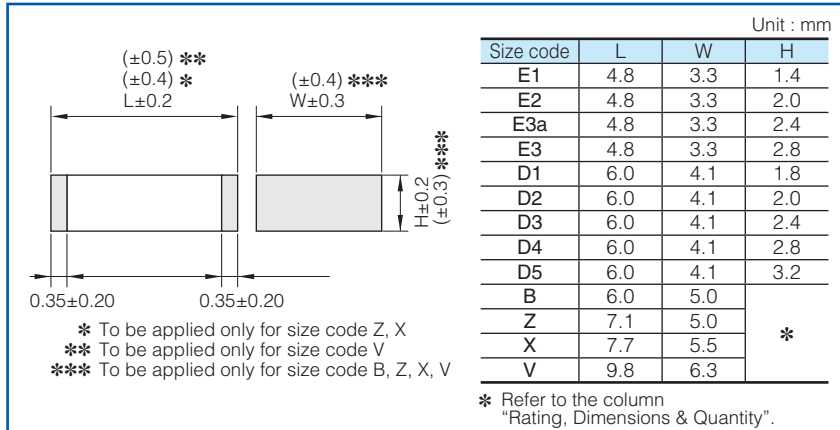

Taping specification for automatic mounting

Refer to the page of taping specifications

Rating · Dimensions · Quantity

- Capacitance tolerance : $\pm 5\%$ (J), $\pm 10\%$ (K)

Capacitance (μF)	Rated voltage 100 V.DC						Rated voltage 250 V.DC					
	Part No.	Dimensions (mm)			Size code	Q'ty	Part No.	Dimensions (mm)			Size code	Q'ty
		L	W	H				L	W	H		
0.0010						ECWU2102□C9	4.8	3.3	1.4	E1	3000	
0.0012						ECWU2122□C9	4.8	3.3	1.4	E1		
0.0015						ECWU2152□C9	4.8	3.3	1.4	E1		
0.0018						ECWU2182□C9	4.8	3.3	1.4	E1		
0.0022						ECWU2222□C9	4.8	3.3	1.4	E1		
0.0027						ECWU2272□C9	4.8	3.3	1.4	E1		
0.0033						ECWU2332□C9	4.8	3.3	1.4	E1		
0.0039						ECWU2392□C9	4.8	3.3	1.4	E1		
0.0047						ECWU2472□C9	4.8	3.3	1.4	E1		
0.0056						ECWU2562□C9	4.8	3.3	1.4	E1		
0.0068						ECWU2682□C9	4.8	3.3	1.4	E1		
0.0082						ECWU2822□C9	4.8	3.3	1.4	E1		
0.010						ECWU2103□C9	4.8	3.3	1.4	E1		
0.012	ECWU1123□C9	4.8	3.3	1.4	E1	ECWU2123□C9	4.8	3.3	1.4	E1		2000
0.015	ECWU1153□C9	4.8	3.3	1.4	E1	ECWU2153□C9	4.8	3.3	1.4	E1		
0.018	ECWU1183□C9	4.8	3.3	1.4	E1	ECWU2183□C9	4.8	3.3	2.0	E2		
0.022	ECWU1223□C9	4.8	3.3	1.4	E1	ECWU2223□C9	4.8	3.3	2.0	E2		
0.027	ECWU1273□C9	4.8	3.3	1.4	E1	ECWU2273□C9	4.8	3.3	2.4	E3a		
0.033	ECWU1333□C9	4.8	3.3	1.4	E1	ECWU2333□C9	4.8	3.3	2.8	E3		
0.039	ECWU1393□C9	4.8	3.3	1.4	E1	ECWU2393□C9	6.0	4.1	2.0	D2		
0.047	ECWU1473□C9	4.8	3.3	2.0	E2	ECWU2473□C9	6.0	4.1	2.4	D3		
0.056	ECWU1563□C9	4.8	3.3	2.0	E2	ECWU2563□C9	6.0	4.1	2.8	D4		
0.068	ECWU1683□C9	4.8	3.3	2.4	E3a	ECWU2683□C9	6.0	4.1	3.2	D5		
0.082	ECWU1823□C9	4.8	3.3	2.8	E3	ECWU2823□C9	6.0	5.0	3.2	B		
0.10	ECWU1104□C9	6.0	4.1	1.8	D1	ECWU2104□C9	6.0	5.0	3.8	B	1500	
	ECWU1104V33	4.8	3.3	2.8	E3							
0.12	ECWU1124□C9	6.0	4.1	2.4	D3	ECWU2124□C9	6.0	5.0	4.5	B		
0.15	ECWU1154□C9	6.0	4.1	2.8	D4							
0.18	ECWU1184KC9	7.1	5.0	2.0	Z							
0.22	ECWU1224KC9	7.1	5.0	2.4	Z							
0.27	ECWU1274KC9	7.1	5.0	2.9	Z							
0.33	ECWU1334KC9	7.1	5.0	3.5	Z							
0.39	ECWU1394KCV	7.7	5.5	3.4	x							
0.47	ECWU1474KCV	7.7	5.5	4.0	x							
0.56	ECWU1564KCV	9.8	6.3	3.0	V							
0.68	ECWU1684KCV	9.8	6.3	3.6	V							
0.82	ECWU1824KCV	9.8	6.3	4.3	V							
1.0	ECWU1105KCV	9.8	6.3	5.1	V							

* □ : Capacitance tolerance

Rating · Dimensions · Quantity

- Capacitance tolerance : $\pm 5\%$ (J)

Capacitance (μF)	Rated voltage 630 V.DC					Size code	Q'ty
	Part No.	Dimensions (mm)					
		L	W	H			
0.022	ECWUC2J223JV	7.1	6.3	3.6	Y	1000	
0.027	ECWUC2J273JV	7.1	6.3	4.1	Y		
0.033	ECWUC2J333JV	7.1	6.3	5.1	Y		

Recommended for land dimensions

Unit : mm

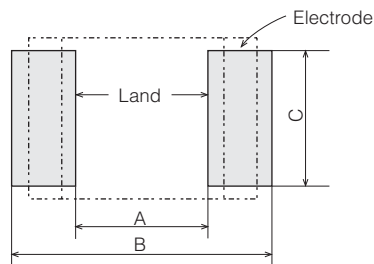

Size code	Land dimensions		
	Reflow soldering		
	A	B	C
E1, E2, E3a, E3	2.6	6.6	3.0
D1, D2, D3, D4, D5	3.8	7.8	3.8
B	3.8	7.8	4.6
Z	4.5	9.0	4.6
Y	4.5	9.0	5.7
X	5.1	9.7	5.0
V	7.2	11.9	5.7

* It is not warrantable that you can mount the capacitor without trouble under all the mounting condition when "Recommender for Land dimensions" is adopted.