



NGTB20N60L2TF1G

N-Channel IGBT 600V, 20A, $V_{CE(sat)}$;1.45V TO-3PF-3L with Low V_F Switching Diode

ON Semiconductor®

<http://onsemi.com>

Features

- IGBT $V_{CE(sat)}$ =1.45V typ. (I_C =20A, V_{GE} =15V)
- IGBT t_f =67ns typ.
- Diode V_F =1.5V typ. (I_F =20A)
- Diode t_{rr} =70ns typ.
- Adaption of full isolation type package
- Enhancement type
- Maximum junction temperature T_j =175°C

Applications

- Power factor correction of white goods appliance
- General purpose inverter

Specifications

Absolute Maximum Ratings at $T_a = 25^\circ\text{C}$, Unless otherwise specified

Parameter	Symbol	Conditions	Ratings	Unit	
Collector to Emitter Voltage	V_{CES}		600	V	
Gate to Emitter Voltage	V_{GES}		± 20	V	
Collector Current (DC)	I_C^{*1}	Limited by T_{jmax}	@ $T_c=25^\circ\text{C} *2$	40	A
			@ $T_c=100^\circ\text{C} *2$	20	A
Collector Current (Pulse)	I_{CP}	Pulse width Limited by T_{jmax}	80	A	
Diode Average Output Current	I_O		20	A	
Allowable Power Dissipation	P_D	$T_c=25^\circ\text{C}$ (Our ideal heat dissipation condition) *2	64	W	

Note : *1 Collector Current is calculated from the following formula.

Continued on next page.

$$I_C(T_c) = \frac{T_{jmax} - T_c}{R_{th(j-c)} \times V_{CE(sat)}(T_{jmax}, I_C(T_c))}$$

*2 Our condition is radiation from backside.

The method is applying silicone grease to the backside of the device and attaching the device to water-cooled radiator made of aluminium.

Stresses exceeding Maximum Ratings may damage the device. Maximum Ratings are stress ratings only. Functional operation above the Recommended Operating Conditions is not implied. Extended exposure to stresses above the Recommended Operating Conditions may affect device reliability.

Package Dimensions

unit : mm (typ) 7538-001

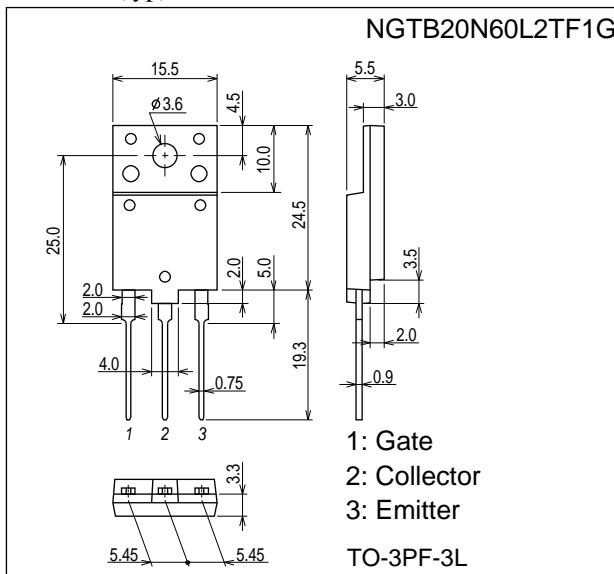

Ordering & Package Information

Device	Package	Shipping	note
NGTB20N60L2TF1G	TO-3PF-3L SC-94	30 pcs. / tube	Pb-Free

Marking

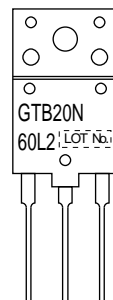

Electrical Connection

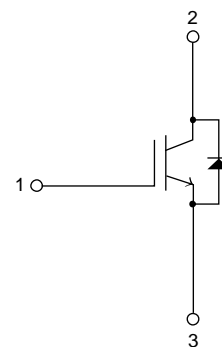

NGTB20N60L2TF1G

Continued from preceding page.

Parameter	Symbol	Conditions	Ratings	Unit
Junction Temperature	T _j		175	°C
Storage Temperature	T _{stg}		- 55 to +175	°C

Electrical Characteristics at T_a = 25°C, Unless otherwise specified

Parameter	Symbol	Conditions	Ratings			Unit
			min	typ	max	
Collector to Emitter Breakdown Voltage	V _{(BR)CES}	I _C =500μA, V _{GE} =0V	600			V
Collector to Emitter Cut off Current	I _{CES}	V _{CE} =600V, V _{GE} =0V T _c =25°C T _c =150°C			10	μA
					1	mA
Gate to Emitter Leakage Current	I _{GES}	V _{GE} =±20V, V _{CE} =0V			±100	nA
Gate to Emitter Threshold Voltage	V _{GE(th)}	V _{CE} =20V, I _C =250μA	4.5		6.5	V
Collector to Emitter Saturation Voltage	V _{CE(sat)}	V _{GE} =15V, I _C =20A T _c =25°C T _c =150°C		1.45	1.65	V
				1.8		V
Diode Forward Voltage	V _F	I _F =20A		1.5		V
Input Capacitance	C _{ies}	V _{CE} =20V, f=1MHz		2000		pF
Output Capacitance	C _{oes}			60		pF
Reverse Transfer Capacitance	C _{res}			50		pF
Turn-ON Delay Time	t _{d(on)}			60		ns
Rise Time	t _r	V _{CC} =300V, I _C =20A R _G =30Ω, L=200μH V _{GE} =0V/15V, V _{clamp} =400V See Fig.1, Fig.2		37		ns
Turn-ON Time	t _{on}			400		ns
Turn-OFF Delay Time	t _{d(off)}			193		ns
Fall Time	t _f			67		ns
Turn-OFF Time	t _{off}			281		ns
Total Gate Charge	Q _g				84	
Gate to Emitter Charge	Q _{ge}	V _{CE} =300V, V _{GE} =15V, I _C =20A		16		nC
Gate to Collector "Miller" Charge	Q _{gc}			37		nC
Diode Reverse Recovery Time	t _{rr}		I _F =10A, di/dt=100A/μs, V _{CC} =50V See Fig.3		70	

Thermal Characteristics at T_a = 25°C, Unless otherwise specified

Parameter	Symbol	Conditions	Ratings	Unit
Thermal Resistance IGBT (junction- case)	R _{th(j-c)} (IGBT)	T _c =25°C (our ideal heat dissipation condition)*2	2.33	°C /W
Thermal Resistance Diode (junction- case)	R _{th(j-c)} (Diode)	T _c =25°C (our ideal heat dissipation condition)*2	2.36	°C /W
Thermal Resistance (junction- atmosphere)	R _{th(j-a)}		47.5	°C /W

NGTB20N60L2TF1G

Fig.1 Switching Time Test Circuit

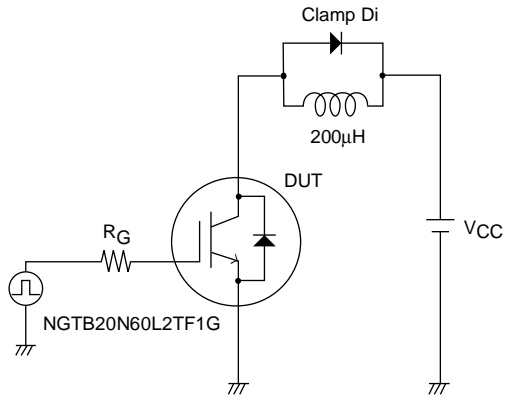

Fig.2 Timing Chart

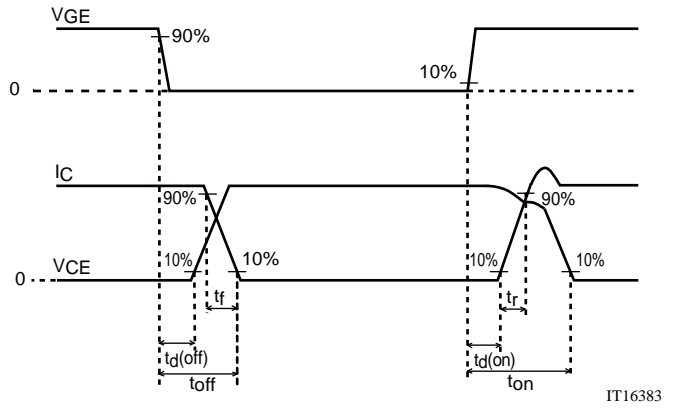
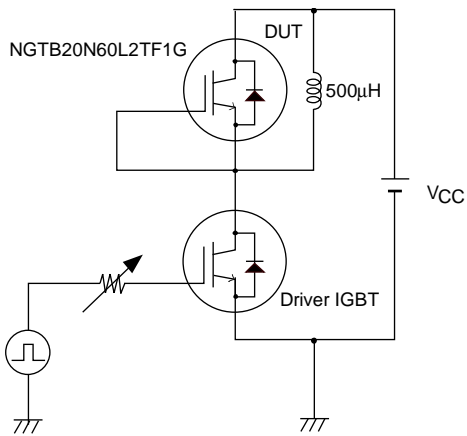
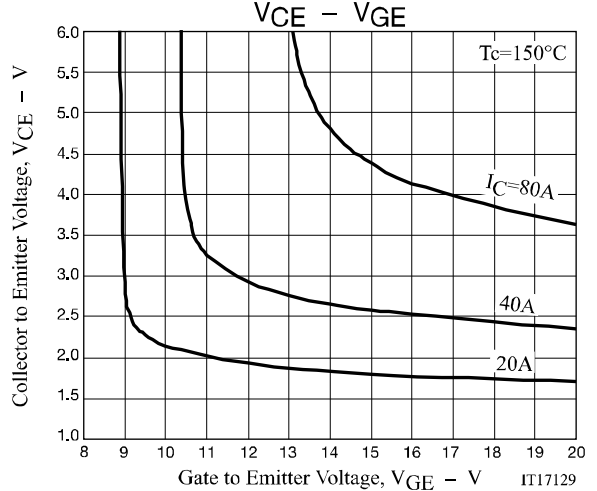
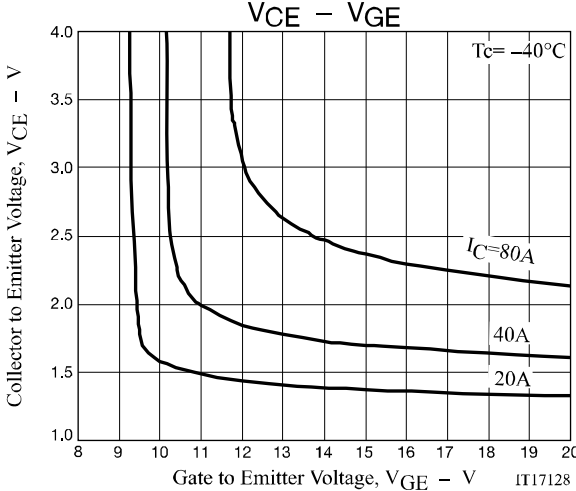
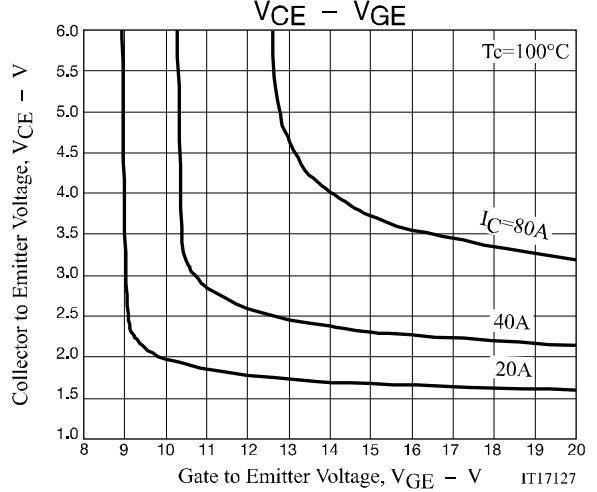
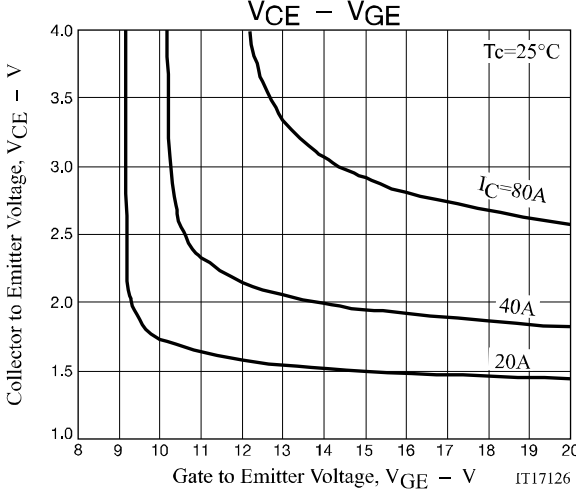
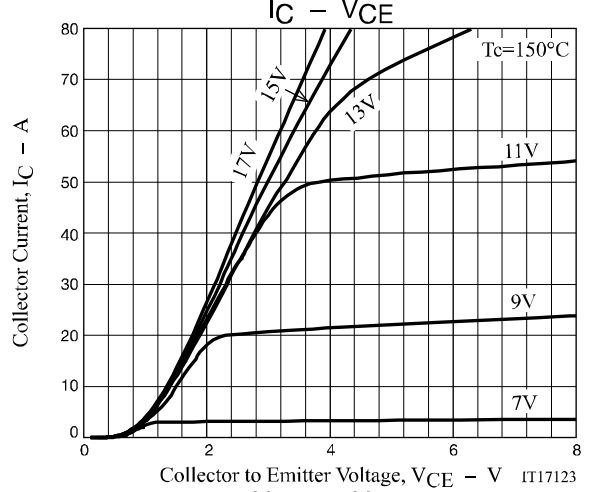
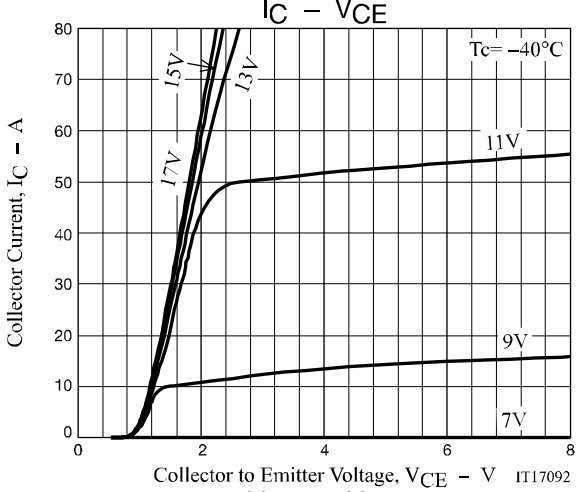
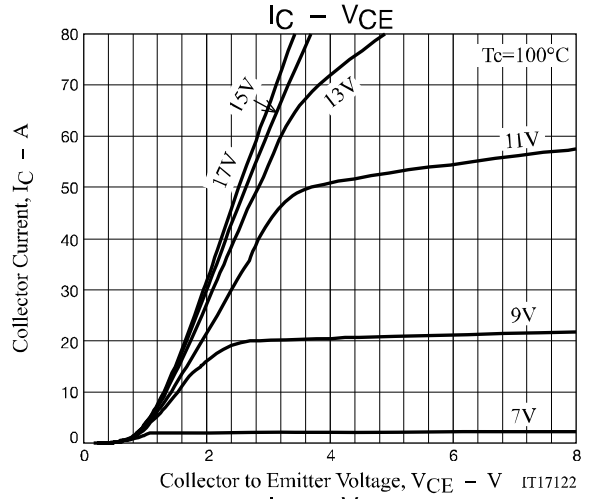
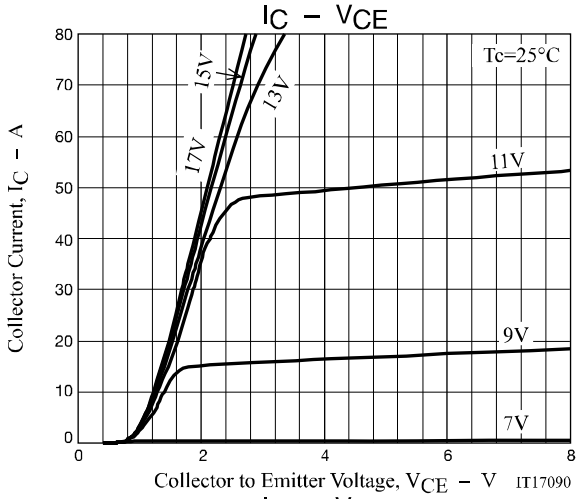

Fig.3 Reverse Recovery Time Test Circuit



NGTB20N60L2TF1G



NGTB20N60L2TF1G

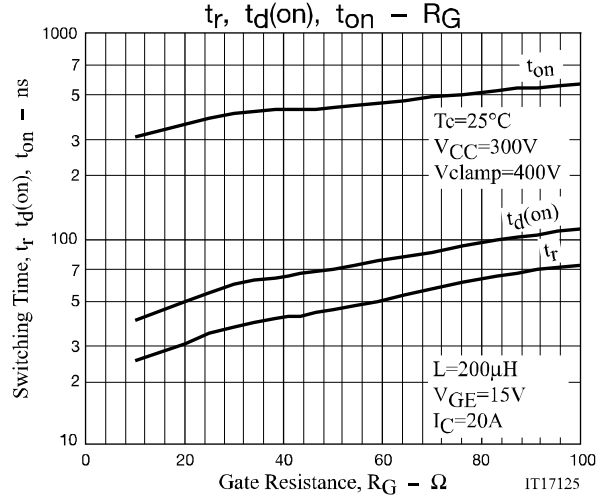
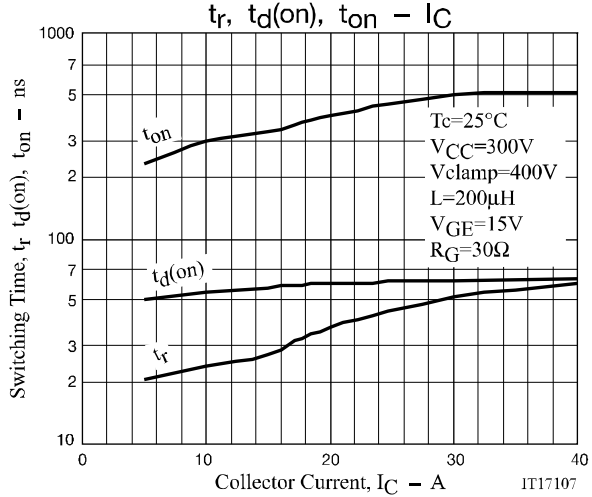
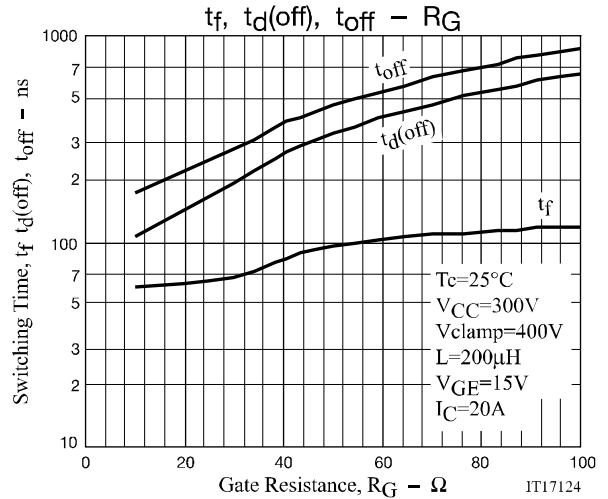
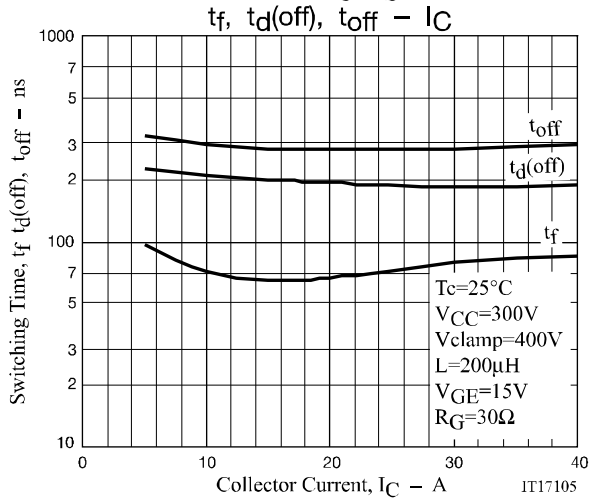
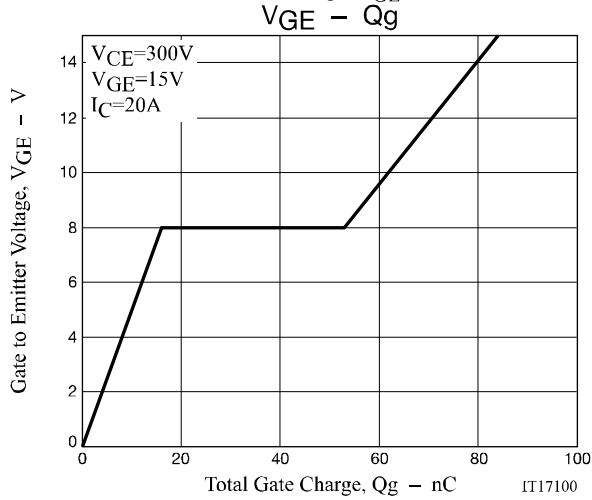
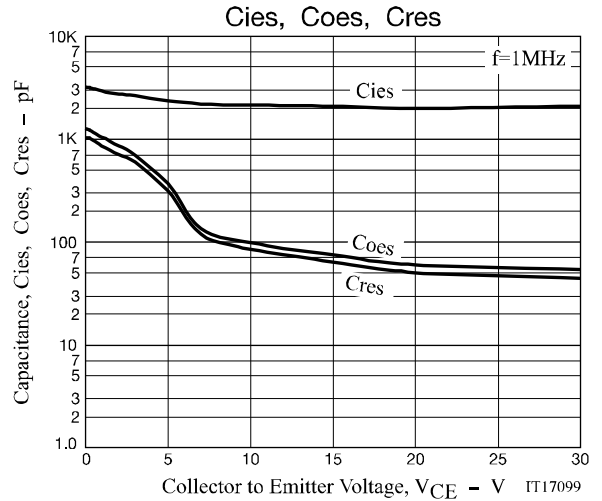
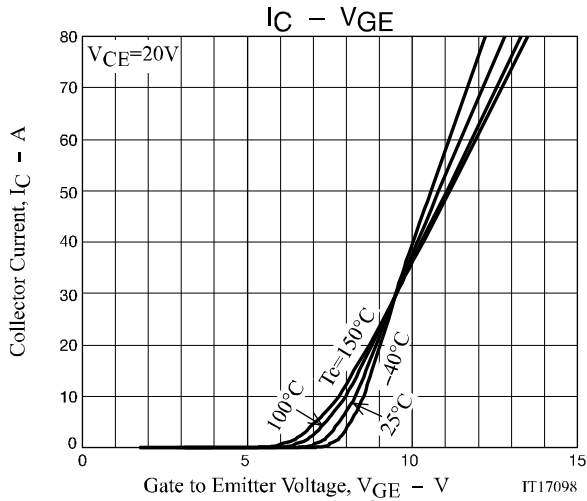

NGTB20N60L2TF1G

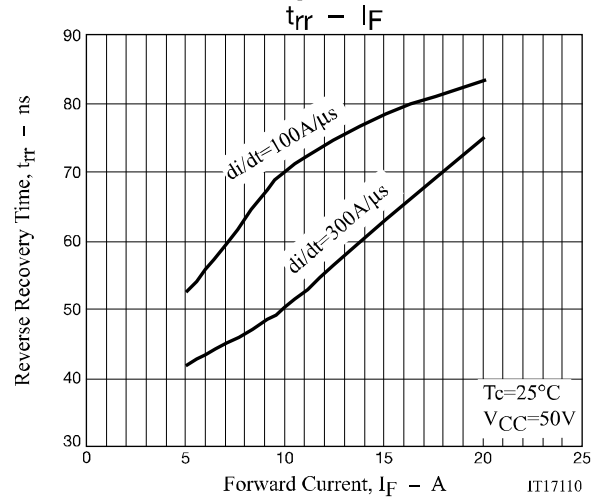
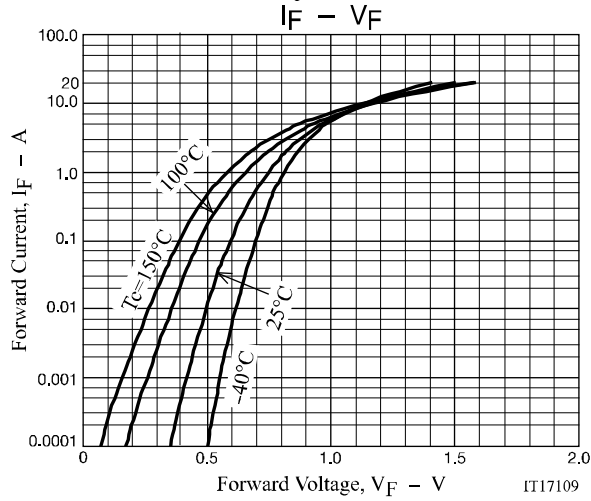
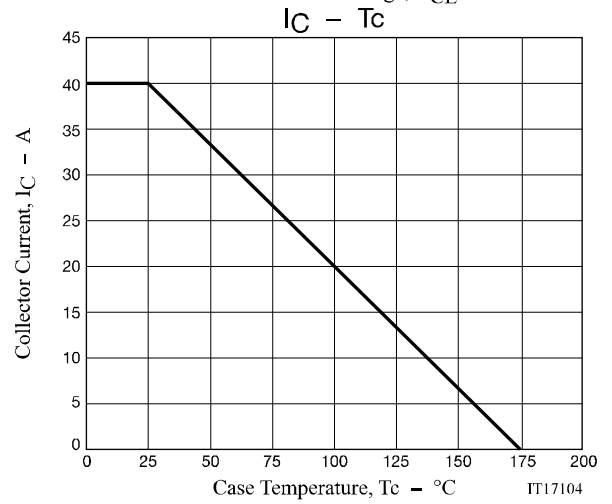
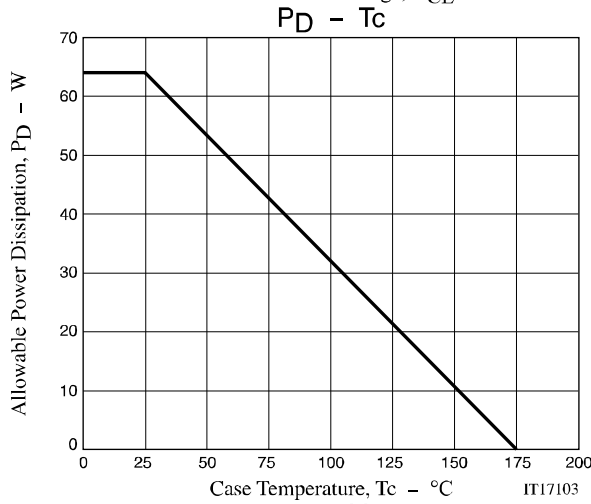
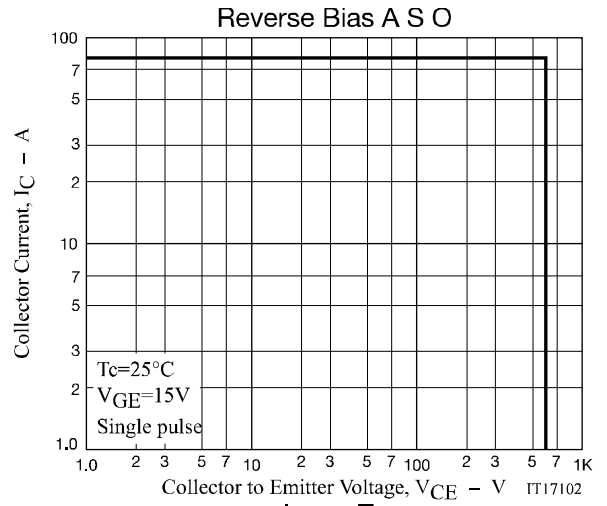
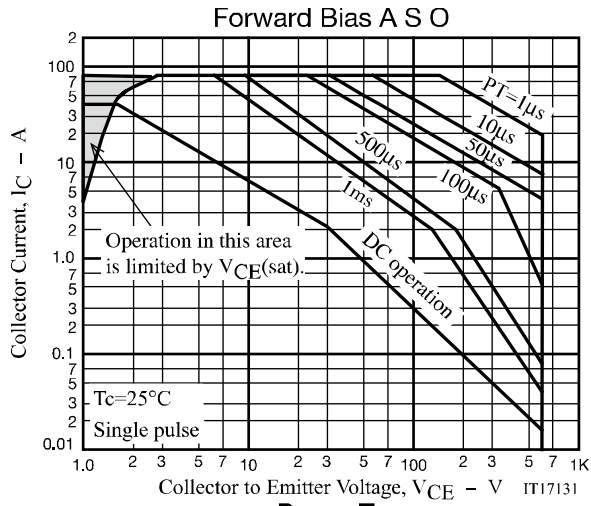

NGTB20N60L2TF1G

Outline Drawing

NGTB20N60L2TF1G

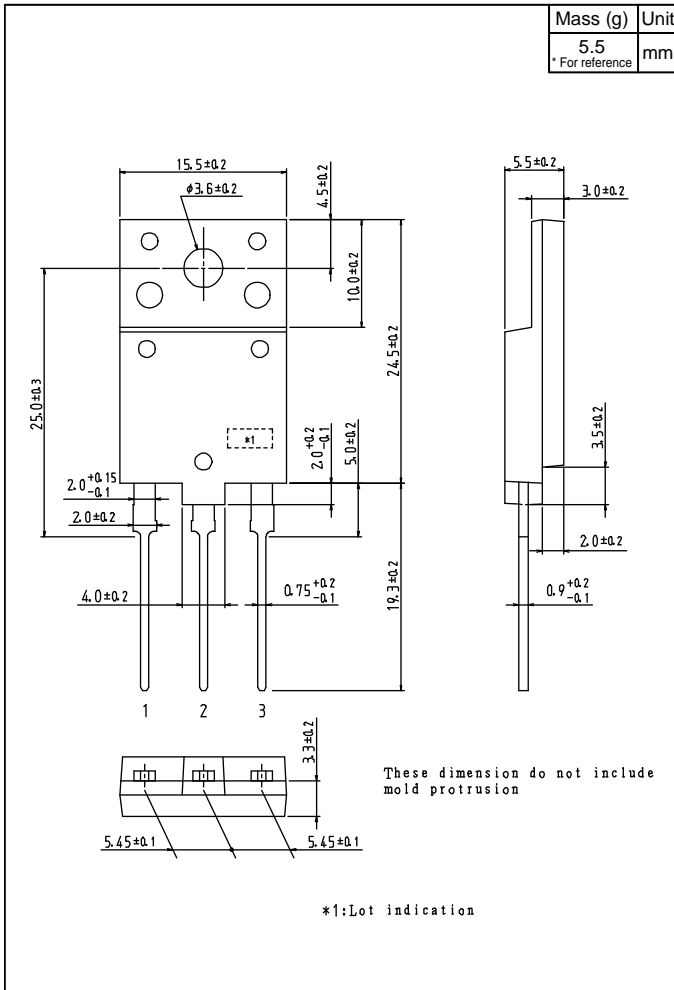

ON Semiconductor and the ON logo are registered trademarks of Semiconductor Components Industries, LLC (SCILLC). SCILLC owns the rights to a number of patents, trademarks, copyrights, trade secrets, and other intellectual property. A listing of SCILLC's product/patent coverage may be accessed at www.onsemi.com/site/pdf/Patent-Marking.pdf. SCILLC reserves the right to make changes without further notice to any products herein. SCILLC makes no warranty, representation or guarantee regarding the suitability of its products for any particular purpose, nor does SCILLC assume any liability arising out of the application or use of any product or circuit, and specifically disclaims any and all liability, including without limitation special, consequential or incidental damages. "Typical" parameters which may be provided in SCILLC data sheets and/or specifications can and do vary in different applications and actual performance may vary over time. All operating parameters, including "Typicals" must be validated for each customer application by customer's technical experts. SCILLC does not convey any license under its patent rights nor the rights of others. SCILLC products are not designed, intended, or authorized for use as components in systems intended for surgical implant into the body, or other applications intended to support or sustain life, or for any other application in which the failure of the SCILLC product could create a situation where personal injury or death may occur. Should Buyer purchase or use SCILLC products for any such unintended or unauthorized application, Buyer shall indemnify and hold SCILLC and its officers, employees, subsidiaries, affiliates, and distributors harmless against all claims, costs, damages, and expenses, and reasonable attorney fees arising out of, directly or indirectly, any claim of personal injury or death associated with such unintended or unauthorized use, even if such claim alleges that SCILLC was negligent regarding the design or manufacture of the part. SCILLC is an Equal Opportunity/Affirmative Action Employer. This literature is subject to all applicable copyright laws and is not for resale in any manner.