

LED SCHEMATIC

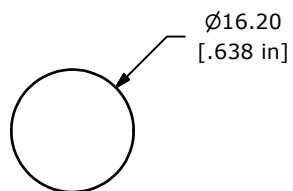

RECOMMENDED
PANEL MOUNTING
1-6mm THICKNESS

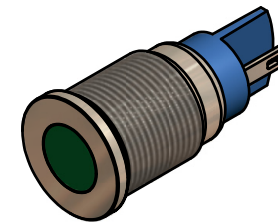
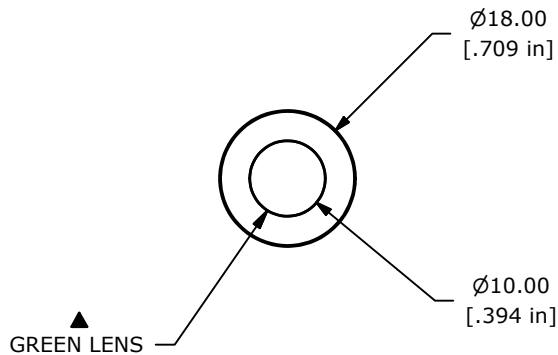

NOTE:

1. ALL DIMENSIONS IN MM [INCH]
2. GENERAL TOLERANCE: X.X = ±0.4
X.XX = ±0.25
3. TERMINAL NUMBERS FOR REF ONLY
4. OPERATING TEMP: -25°C to 55°C
5. CURRENT RATING: 2mA-20mA
- ▲ 6. LAMP VOLTAGE: 2.8V
7. IP RATING: IP67
8. ▲ DENOTES CRITICAL PARAMETER.
9. HARDWARE SUPPLIED: O-RING AND HEXNUT
10. 2002/95/EC (ROHS) COMPLIANT.

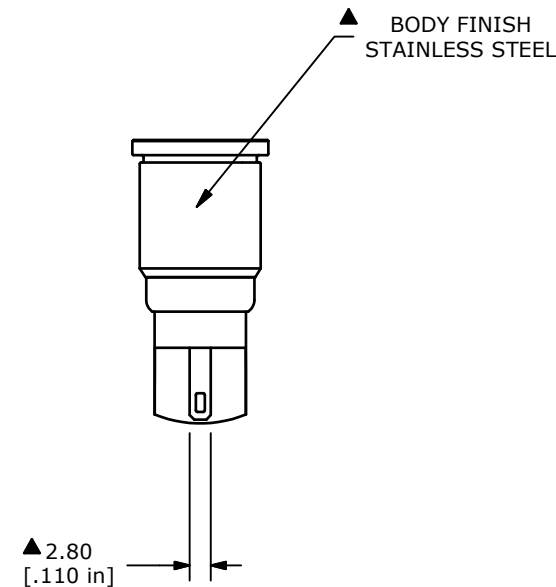
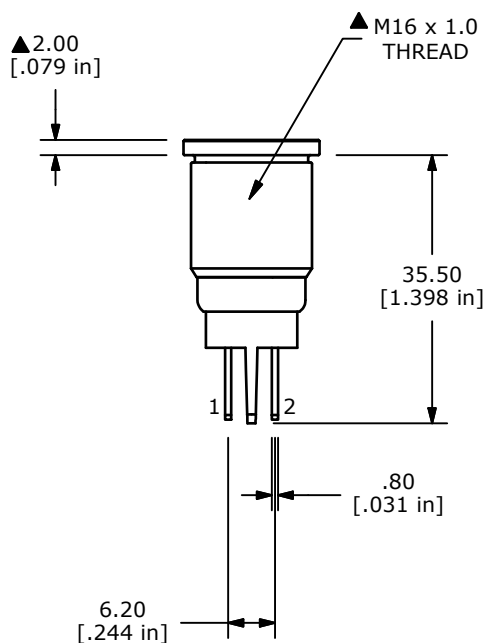

TITLE PVL16FLS31

A	22135	New Release	1/27/16	rc
REV	PCR NO	DESCRIPTION	DATE	BY

THE INFORMATION CONTAINED IN THIS DOCUMENT IS PROPRIETARY TO E-SWITCH AND IS NOT TO BE COPIED OR TRANSFERRED

SCALE 1:1	DATE 1/27/2016	DR rc	DWG 52-PVL16FLS31	REV A
-----------	----------------	-------	-------------------	-------