

VI TELEFILTER**Filter Specification****TFS 238B****1/5****Measurement condition**

Ambient temperature T_A : 23 °C
 Input power level: 0 dBm
 Terminating impedances at f_C *:
 input: 292 Ω // -13,3 pF
 output: 333 Ω // -12,4 pF

Characteristics

Remark:

The reference level for the relative attenuation a_{rel} of TFS238B is the minimum of the pass band attenuation a_{min} . This value is defined as the insertion loss a_e . The centre frequency f_C is the arithmetic mean value of the upper and lower frequencies at the 1 dB filter attenuation level relative to the insertion loss a_e . The given values for the relative attenuation a_{rel} and the group delay ripple have to be reached at the frequencies given below, even if the centre frequency f_C is shifted due to the temperature coefficient of frequency TC_f in the operating temperature range and due to a production tolerance for the centre frequency f_C .

Data		typ. value	tolerance / limit
Insertion loss (reference level)	a_e	10,5 dB	max. 12 dB
Nominal frequency	f_N	-	238,5 MHz
Centre frequency	f_C	238,5 MHz	-
Relative attenuation	a_{rel}		
f_N	$f_N \pm 2,5$ MHz	0,4 dB	max. 1 dB
$f_N \pm 5$ MHz	$f_N \pm 7,5$ MHz	23 dB	min. 13 dB
$f_N \pm 7,5$ MHz	$f_N \pm 9$ MHz	38 dB	min. 23 dB
$f_N \pm 9$ MHz	$f_N \pm 10$ MHz	50 dB	min. 40 dB
$f_N \pm 10$ MHz	$f_N \pm 100$ MHz	60 dB	min. 47 dB
Phase variation	within $f_N \pm 2,5$ MHz	1,1 deg rms	max. 4 deg rms
Temperature coefficient of frequency (TC_f)**		-18 ppm/K	-
Frequency deviation of f_C over temperature T:		$\Delta f_C(\text{Hz}) = TC_f(\text{ppm/K}) \times (T - T_A) \times f_{CAT}(\text{MHz})$	
Operating temperature range		-	- 20 °C + 85 °C
Storage temperature range		-	- 40 °C + 85 °C
Input power		-	max. 20 dBm

*) The terminating impedances depend on parasitics and q-values of matching elements and the board used, and are to be understood as reference values only. Should there be additional questions do not hesitate to ask for an application note or contact our design team.

generated: _____

checked / approved: _____

TELEFILTER GmbH
Potsdamer Straße 18
D 14 513 TELTOW / Germany
Tel: (+49) 3328 4784-0 / Fax: (+49) 3328 4784-30
E-Mail: tf@telefilter.com

VI TELEFILTER reserves the right to make changes to the product(s) and/or information contained herein without notice. No liability is assumed as a result of their use or application. No rights under any patent accompany the sale of any such product(s) or information

Filter characteristic

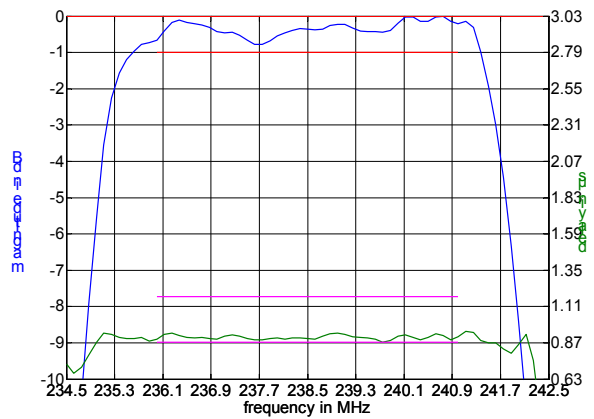
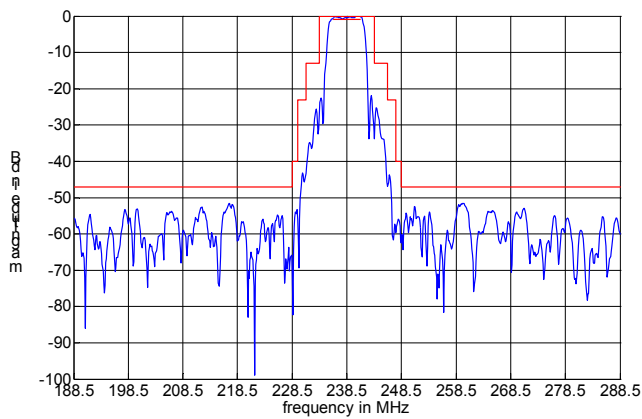

Construction and pin connection

(All dimensions in mm)

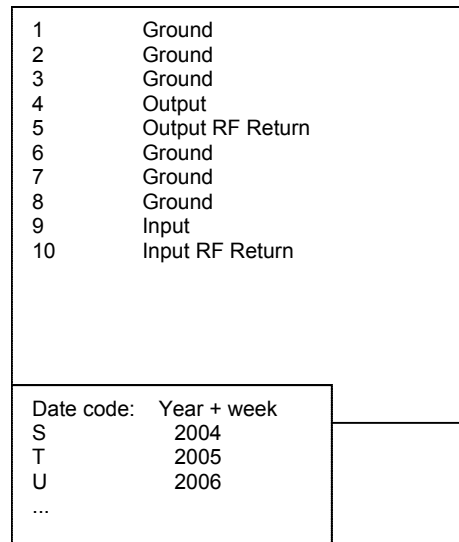
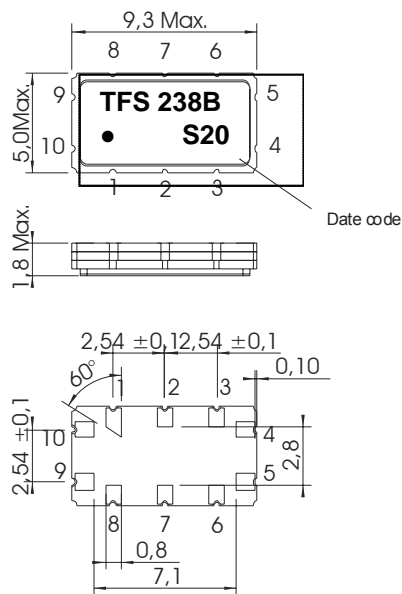

50 Ohm Test circuit

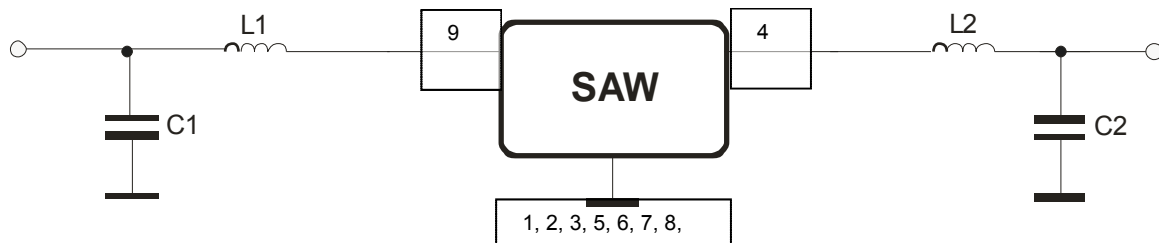

TELEFILTER GmbH
 Potsdamer Straße 18
 D 14 513 TELTOW / Germany
 Tel: (+49) 3328 4784-0 / Fax: (+49) 3328 4784-30
 E-Mail: tft@telefilter.com

VI TELEFILTER reserves the right to make changes to the product(s) and/or information contained herein without notice. No liability is assumed as a result of their use or application. No rights under any patent accompany the sale of any such product(s) or information

Stability characteristics

After the following tests the filter shall meet the whole specification:

1. Shock: 500g, 18 ms, half sine wave, 3 shocks each plane;
DIN IEC 68 T2 - 27
2. Vibration: 10 Hz to 500 Hz, 0,35 mm or 5g respectively, 1 octave per min, 10 cycles per plan, 3 plans;
DIN IEC 68 T2 - 6
3. Change of temperature: -55 °C to 125°C / 30 min. each / 10 cycles
DIN IEC 68 part 2 – 14 Test N
4. Resistance to solder heat (reflow): reflow possible: twice max.;
for temperature conditions, please refer to the attached "Air reflow temperature conditions" on page 4;

Packing

Tape & Reel:	DIN IEC 286 – 3, with exception of value for N and minimum bending radius; tape type II, embossed carrier tape with top cover tape on the upper side;	
	max. pieces of filters per reel:	1700
	reel of empty components at start:	min 300 mm
	reel of empty components at start including leader:	min 500 mm
	trailer	min 300 mm

Tape (all dimensions in mm)

W	: 24 ± 0,3
Po	: 4 ± 0,1
Do	: 1,5 ± 0,1
E	: 1,75 ± 0,1
F	: 11,5 ± 0,1
G (min)	: 0,60
P2	: 2 ± 0,1
P1	: 12 ± 0,1
D1(min)	: 1,5
Ao	: 7,1 ± 0,2
Bo	: 13,9 ± 0,2
Ct	: 21,5 ± 0,1

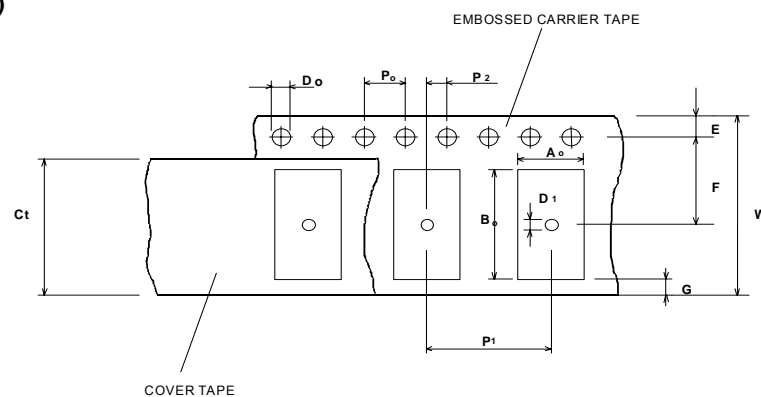
**Reel (all dimensions in mm):**

A	: 330
W1	: 24,40 +2,0
W2 (max)	: 30,4
N (min)	: 60
C	: 13 ± 0,5/-0,2

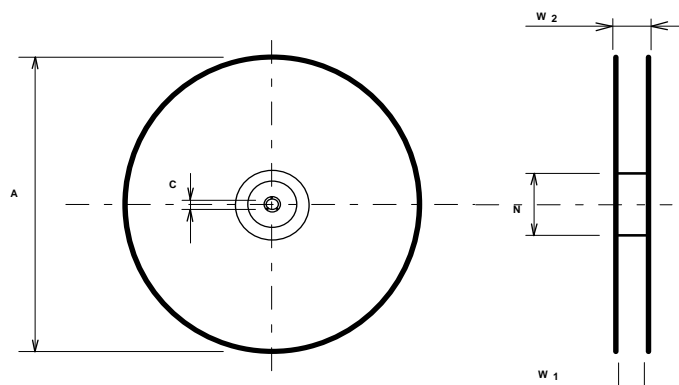

The minimum bending radius is 45 mm. The mounting surface of the filters faces the bottom side of the embossed carrier tape. Markings on the filters can be read if the upper side of the carrier tape is regarded with the sprocket holes on its right.

TELEFILTER GmbH**Potsdamer Straße 18****D 14 513 TELTOW / Germany****Tel: (+49) 3328 4784-0 / Fax: (+49) 3328 4784-30****E-Mail: tf@telefilter.com**

VI TELEFILTER reserves the right to make changes to the product(s) and/or information contained herein without notice. No liability is assumed as a result of their use or application. No rights under any patent accompany the sale of any such product(s) or information

Air reflow temperature conditions

1st and 2nd air reflow profile

Name:	pre-heating periods	main-heating periods	peak temperature
Temperature:	150 °C - 170 °	Cover 200 °C	255 °C ± 5 °C
Time:		60 sec. - 90 sec.	20 sec. - 25 sec.

Air reflow profile

Table for temperature vs. time during the air reflow process

Tolerance of temperatures: ± 5 °C

time / sec.	temperature / °C	time / sec.	temperature / °C
0	23	140	160
10	34	150	161
20	46	160	164
30	60	170	170
40	80	180	180
50	103	190	205
60	121	195	230
70	134	200	255
80	143	205	230
90	150	210	205
100	154	215	180
110	156	220	165
120	158	230	140
130	159	240	120

History

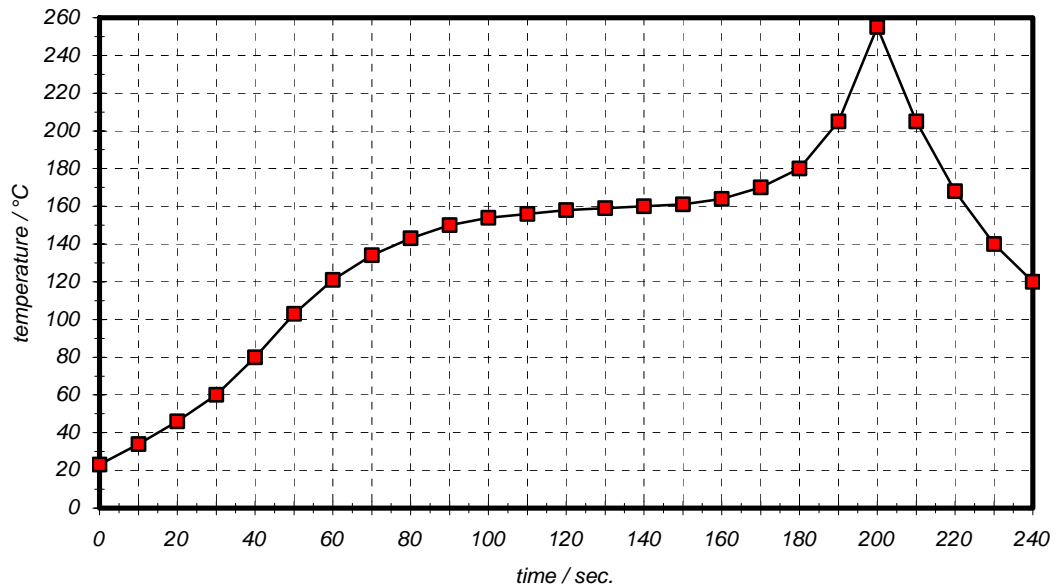
Version	Reason of Changes	Name	Date
1.0	generation of specification	Pfeiffer	12.05.2004