

For LED	L1 Series (Joint type)
LED lighting connector	

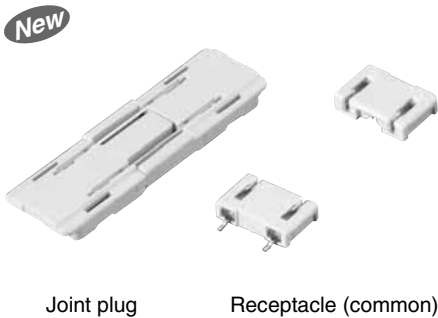

RoHS compliant

FEATURES

1. Small and low profile design does not obstruct the LED light
 The connector is of a 2.4 mm pitch two pins board joint type. The LED light is not obstructed by the low profile (1.4 mm mated height) L1 series connector.
Explanatory diagram of the connector mounted on a circuit board

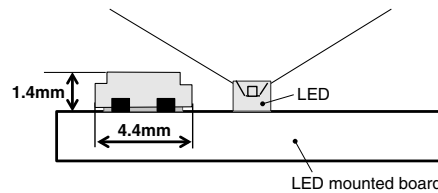

- 3. Safety covered by ensuring insulation distance (Min. 1.6 mm)**
- 4. Mating lock construction using molded lock**
- 5. Unmating configured with jig**

APPLICATIONS

Straight LED tube lights, LED base lights, etc.

2. Floating design

The three-directional floating function (X: ±0.3 mm, Y: ±0.5 mm, Z: ±0.3 mm) accommodates thermal expansion of circuit boards.

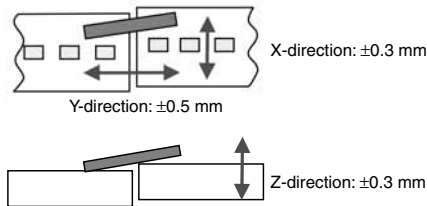

ORDERING INFORMATION

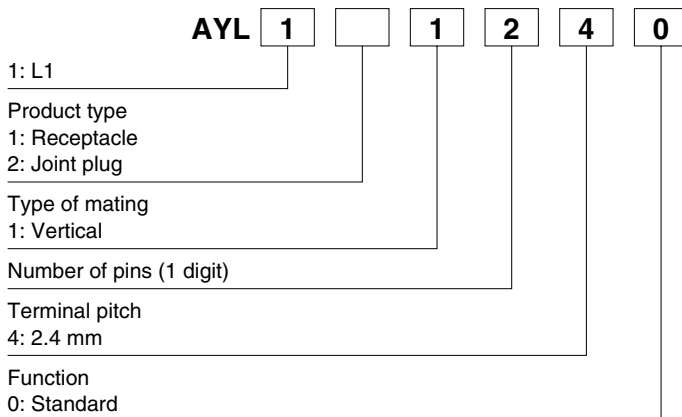

PRODUCT TYPES

1. Receptacle

Mated height	Part No.	Packing	
		Inner carton (1-reel)	Outer carton
1.4mm	AYL111240	5,000 pieces	10,000 pieces

2. Joint plug

Mated height	Part No.	Packing	
		Inner carton (1-reel)	Outer carton
1.4mm	AYL121240	5,000 pieces	10,000 pieces

Note: Order unit:

For volume production: 1-inner carton (1-reel) units

Samples for mounting check: Receptacle (AYL111240) 50 units, Joint plug (AYL121240) 25 units. Please contact our sales office.

SPECIFICATIONS

1. Characteristics

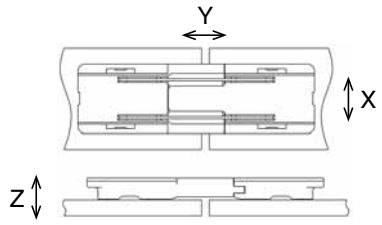
Item		Specifications	Conditions																		
Electrical characteristics	Rated current	1.0A/pin contact																			
	Rated voltage	125V AC/DC																			
	Breakdown voltage	1,250V AC for 1 min.	No short-circuiting or damage at a detection current of 1 mA when the specified voltage is applied for one minute.																		
	Insulation resistance	Min. 1,000M Ω (initial)	Using 500V DC megger (applied for 1 min.)																		
	Contact resistance	Max. 90m Ω	Based on the contact resistance measurement method specified by JIS C 5402. Two contacts of receptacle and a post of joint plug																		
Mechanical characteristics	Composite insertion force (initial)	Max. 25.2N	Insertion force of two receptacles and a joint plug																		
	Composite removal force (initial)	Min. 4.0N	Removal force of two receptacles and a joint plug																		
	Floating distance (Receptacle and joint plug mated)	X direction: ± 0.3 mm Y direction: ± 0.5 mm Z direction: ± 0.3 mm																			
Environmental characteristics	Ambient temperature	-40°C to +105°C	No freezing at low temperatures. No dew condensation.																		
	Storage temperature	-40°C to +85°C (product only) -40°C to +50°C (packing structure)	No freezing at low temperatures. No dew condensation.																		
	Thermal shock resistance (Receptacle and plug)	200 cycles, insulation resistance min. 100M Ω , contact resistance max. 90m Ω	Conformed to MIL-STD-202F, method 107G <table border="1"> <thead> <tr> <th>Order</th> <th>Temperature (°C)</th> <th>Time (minutes)</th> </tr> </thead> <tbody> <tr> <td>1</td> <td>-40$\frac{3}{4}$</td> <td>30</td> </tr> <tr> <td>2</td> <td>\int</td> <td>Max. 5</td> </tr> <tr> <td>3</td> <td>105$\frac{3}{4}$</td> <td>30</td> </tr> <tr> <td>4</td> <td>\int</td> <td>Max. 5</td> </tr> <tr> <td></td> <td>-40$\frac{3}{4}$</td> <td></td> </tr> </tbody> </table>	Order	Temperature (°C)	Time (minutes)	1	-40 $\frac{3}{4}$	30	2	\int	Max. 5	3	105 $\frac{3}{4}$	30	4	\int	Max. 5		-40 $\frac{3}{4}$	
	Order	Temperature (°C)	Time (minutes)																		
	1	-40 $\frac{3}{4}$	30																		
	2	\int	Max. 5																		
3	105 $\frac{3}{4}$	30																			
4	\int	Max. 5																			
	-40 $\frac{3}{4}$																				
Humidity resistance (Receptacle and plug)	500 hours, insulation resistance min. 100M Ω , contact resistance max. 90m Ω	Bath temperature 85 ± 2 °C, humidity 80 to 85% R.H.																			
Saltwater spray resistance (Receptacle and plug)	24 hours, insulation resistance min. 100M Ω , contact resistance max. 90m Ω	Conformed to MIL-STD-1344A, method 1001 Bath temperature 35 ± 2 °C, saltwater concentration 5 ± 1 %																			
H ₂ S resistance (Receptacle and plug)	48 hours, contact resistance max. 90m Ω	Conformed to JEIDA-38-1984 Bath temperature 40 ± 2 °C, gas concentration 3 ± 1 ppm, humidity 75 to 80% R.H.																			
Durability	3 times, contact resistance max. 90m Ω	Using removal tool																			
Soldering temperature resistance	Receptacle	The initial specification must be satisfied electrically and mechanically	Reflow soldering: Max. peak temperature of 260°C, Max. 2 times (PC board surface temperature near connector terminals) Soldering iron: 300°C within 5 s 350°C within 3s																		
Solder paste thickness		The initial specification must be satisfied electrically and mechanically	Recommendation t = 0.12 mm screen																		

Note: The preceding show characteristics, when mated with receptacle and Joint plug.

2. Material and surface treatment

1. Receptacle

Part name	Material	Color	Surface treatment
Molded portion	LCP resin (UL94V-0)	White	—
Contact	Copper alloy	—	Contact portion: Pd-Ni+Au flash plating over Ni Terminal portion: Au plating over Ni (except the terminal tips)
Soldering terminal	Copper alloy	—	Terminal portion: Au plating over Ni (except the terminal tips)

2. Joint plug

Part name	Material	Color	Surface treatment
Molded portion	LCP resin (UL94V-0)	White	—
Post	Copper alloy	—	Terminal portion: Pd-Ni+Au flash plating over Ni

DIMENSIONS (Unit: mm)

Receptacle

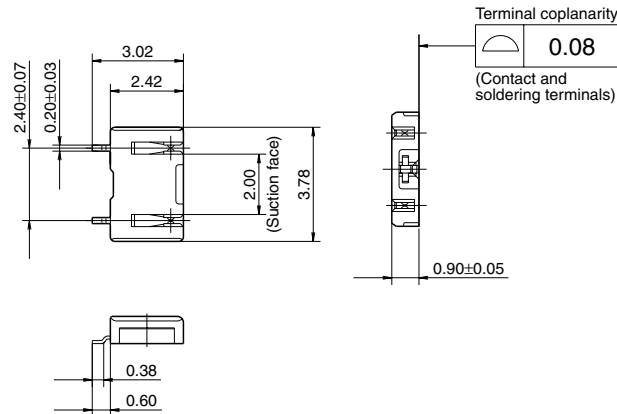

General tolerance: ±0.2

Joint plug

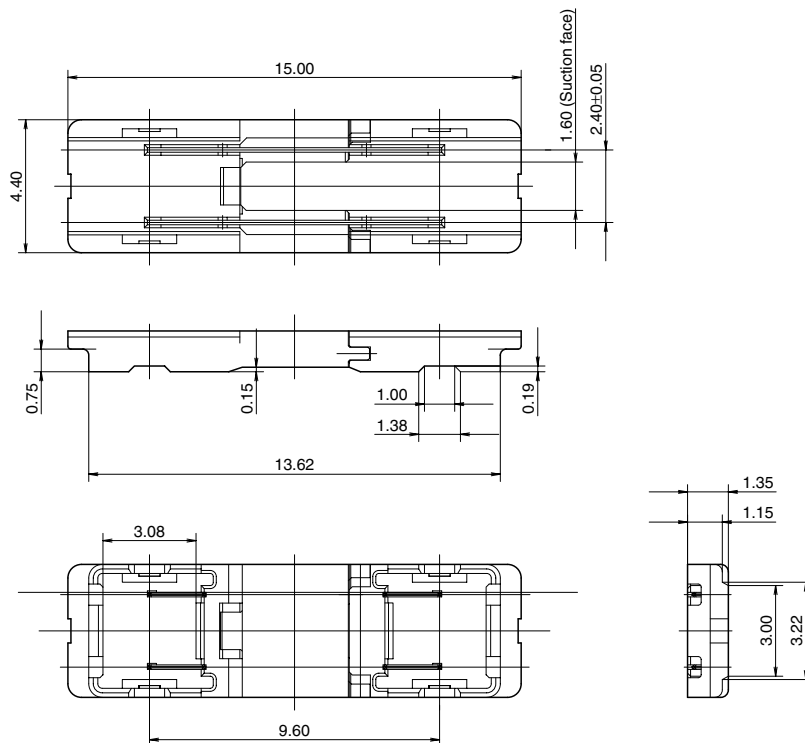

General tolerance: ±0.2

AYL11, 12

Receptacle and Joint plug are mated

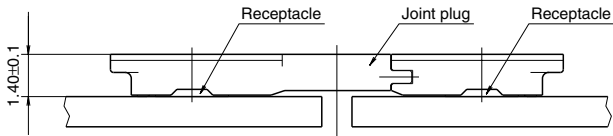

EMBOSSED TAPE DIMENSIONS (Unit: mm)

• Tape packed status Receptacle

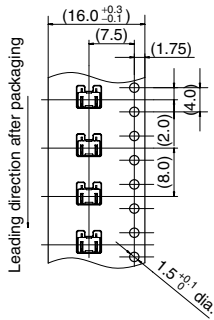

• Specifications for the plastic reel (In accordance with EIAJ ET-7200B.)

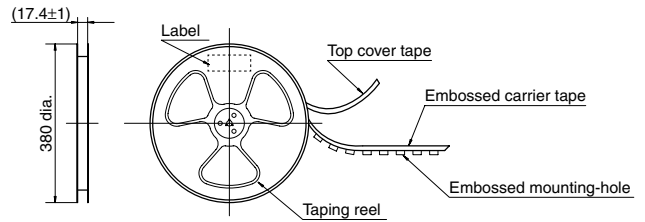

Joint plug

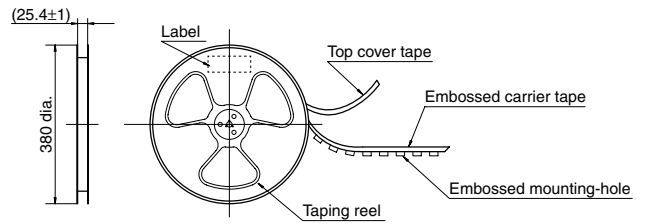
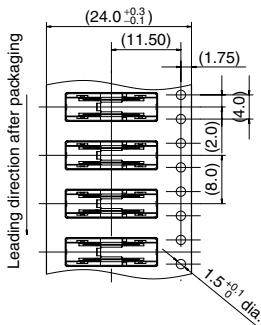

• Connector orientation with respect to embossed tape feeding direction

Direction of tape progress	Type	L1	
	Receptacle		Joint plug

NOTES ON USING CONNECTOR FOR LED LIGHTING

■ Safety precautions

Observe the following safety precautions to prevent accidents and injuries.

1) The use of the connector outside of the specified rated current and breakdown voltage ranges may cause abnormal heating, smoke, and fire.

Never use the connector beyond the specified ranges of the product.

2) In order to avoid accidents, make sure you have thoroughly reviewed the specifications before use.

Consult us if you plan to use the product in a way not covered by the specifications.

3) We are consistently striving to improve quality and reliability. However, the fact remains that electrical components and devices generally fail at a given statistical probability.

Furthermore, their durability varies depending on where and how they are used. Please be sure to verify electrical components and devices under actual conditions before use. Continuously using them in a state of degraded performance may cause deterioration in insulation performance, thus resulting in abnormal heat generation, smoke generation, or fire. To avoid that, we ask you to implement safe designs that include redundancy, fire prevention, and malfunction prevention. Also, please conduct periodic maintenance so that no accidents resulting in injury or death, fire, or harm to society will be caused as a result of product failure or service life.

■ About receptacle

• PC board design

Design the recommended foot pattern in order to secure the mechanical strength in the soldered areas of the terminal.

• Connector mounting

When mounting, if there is too much suction nozzle pressure, the molded and metal parts might deform and break.

Please check beforehand.

In case of dry condition, please care the occurrence of static electricity.

The product may be adhered to the embossed carrier tape or the cover tape in dry condition.

Recommended humidity is between 40 to 60 % and please remove static electricity by ionizer in manufacturing scene.

• Soldering

1) Manual soldering.

• Since this connector is the low profile type the amount of solder supplied should be closely monitored.

Too much solder during manual soldering may cause solder creeping near the contacting part or contact failure.

• Make sure that the soldering iron tip is heated within the temperature and time limits indicated in the specifications.

• Flux from the solder wire may adhere to the contact surfaces during soldering operations. After soldering, carefully check the contact surfaces with a magnifying glass and clean off any flux before use.

• Be aware that a load applied to the connector terminals while soldering may displace the contact.

• Thoroughly clean the soldering iron tip.

Recommended PC board pattern (mounting pad layout)

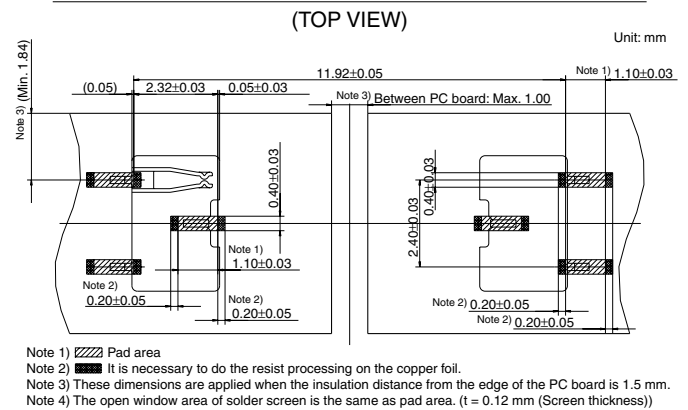

2) Reflow soldering

• Screen-printing is recommended for printing paste solder.

• To determine the relationship between the screen opening area and the PC board foot pattern area, refer to the diagrams in the recommended patterns for PC boards and metal masks.

Make sure to use the terminal tip as a reference position when setting.

• Too much solder may cause solder creeping near the contacting part or contact failure.

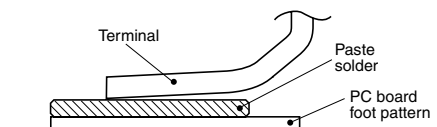

• Consult us when using a screen-printing thickness other than that recommended.

• Depending on the size of the connector being used, self alignment may not be possible. Accordingly, carefully position the terminal with the PC board pattern.

• The recommended reflow temperature profile is given in the figure below

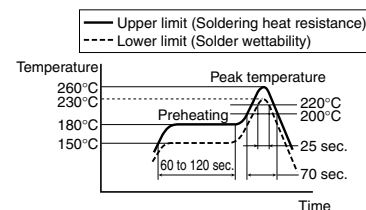

• The temperature is measured on the surface of the PC board near the connector terminal.

• Certain solder and flux types may cause serious solder creeping.

Solder and flux characteristics should be taken into consideration when setting the reflow soldering conditions.

• Do not apply adhesive to secure the connector, because it can affect the spring action of the contact.

• When coating the PC board after soldering the connector to prevent the deterioration of insulation, perform the coating in such a way so that the coating does not get on the connector.

3) Reworking on a soldered portion

• Finish reworking in one operation.

• For reworking of the solder bridge, use a soldering iron with a flat tip. Do not add flux, otherwise, the flux may creep to the contact parts.

• Use a soldering iron whose tip temperature is within the temperature range specified in the specifications.

AYL11, 12

- Do not drop or handle the connector carelessly. Otherwise, the terminals may become deformed due to excessive force or applied solderability may degrade.
- When cutting or bending the PC board after mounting the connector, be careful that the soldered sections are subjected to excessive forces.

■ Insertion / Removal and mating retention of connectors

- Do not insert or remove the connector when it is not soldered. Also, forcibly applied external pressure on the terminals can weaken the adherence of the terminals to the molded part or cause the terminals to lose their evenness.
- Excessive prying-force applied to one end may cause product breakage and separation of the solder joints at the terminal. Excessive force applied for insertion in a pivot action as shown may also cause product breakage.

Always align the connector with the mating part and slide it in parallel.

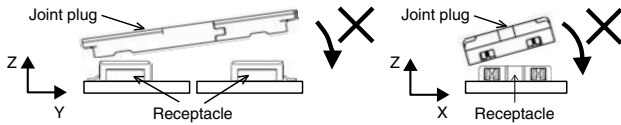

- Pushing the plug excessively when inserting it may deform and break the product.
- This product has simple lock structure for mating. However, connectors may be unmated because of impact by dropping and so on. Please take countermeasures at the equipment side for preventing removal of connectors. In order to prevent removal of connectors, please fix the PC board by frame and so on not to move more than floating distance, especially the neighborhood of connectors.

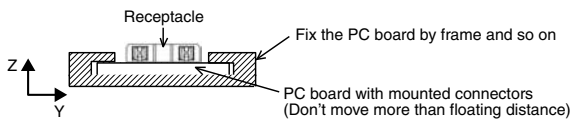

- When removing the connector, please use the recommended removal tool.

After inserting the tip of removal jig under the plug, push down the jig shown in below. (Removable from either the left or right side) Since holding force of mating will decline when removing the connector without using tool, please don't use the remove plug, and exchange to a new plug.

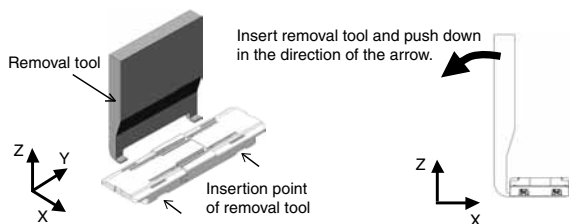

- Although this product has floating structure, it's the performance in the state of receptacles and a plug mated. We can't guarantee mating in the state where receptacles and a plug are shifted from the center. When inserting a plug in receptacles, please check the position of a mutual receptacle.

