

### 15 W wide range SMPS for metering based on ESBT™ STC03DE220HV and L6565 PWM controller

## 1 Introduction

This document describes a 15-W flyback switched mode power supply (SMPS) application that uses an emitter-switched bipolar transistor (ESBT™) switch (STC03DE220HV) and L6565 quasi-resonant pulse-width modulation (PWM) controller.

The application is a universal, cost-effective flyback converter used in metering applications, with an excellent wide-voltage input range from 125 to 1250 VDC, achieved using the ESBT as the main switch and a quasi-resonant PWM driver.

This document is associated with the release of the demonstration board STEVAL-ISA057V1 ([Figure 1](#)).

**Figure 1.** STEVAL-ISA057V1

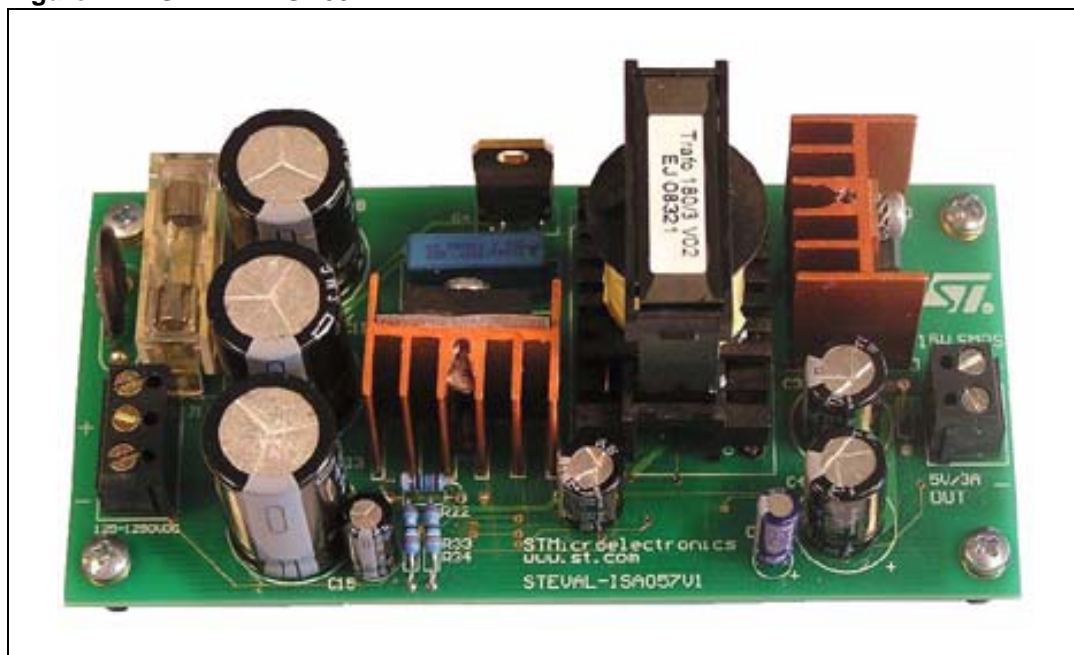

# Contents

<b>1</b>	<b>Introduction</b> .....	<b>1</b>
<b>2</b>	<b>Adapter features</b> .....	<b>5</b>
	2.1 Main characteristics .....	5
	2.2 Circuit description .....	5
<b>3</b>	<b>Waveforms and results</b> .....	<b>10</b>
<b>4</b>	<b>Electrical performances</b> .....	<b>17</b>
<b>5</b>	<b>Functional check</b> .....	<b>21</b>
	5.1 Startup behavior at full loads .....	21
	5.2 Power-down .....	22
	5.3 Short-circuit tests .....	22
<b>6</b>	<b>Thermal measurements</b> .....	<b>25</b>
<b>7</b>	<b>Bill of materials</b> .....	<b>26</b>
<b>8</b>	<b>PCB layout</b> .....	<b>28</b>
<b>9</b>	<b>Transformer specification</b> .....	<b>30</b>
	9.1 Electrical characteristics .....	30
	9.2 Mechanical aspects .....	31
<b>10</b>	<b>Ordering information</b> .....	<b>33</b>
<b>11</b>	<b>Conclusion</b> .....	<b>34</b>
<b>12</b>	<b>References</b> .....	<b>35</b>
<b>13</b>	<b>Revision history</b> .....	<b>36</b>

## List of tables

Table 1.	Line and load regulation . . . . .	17
Table 2.	Efficiency at 125 VDC . . . . .	19
Table 3.	Efficiency at 500 VDC . . . . .	19
Table 4.	Efficiency at 1000 VDC . . . . .	19
Table 5.	Power consumption in no-load conditions . . . . .	20
Table 6.	Temperature of key components at 125 VDC - full load (3 A output current) . . . . .	25
Table 7.	Temperature of key components at 1250 VDC - low load (3 A output current) . . . . .	25
Table 8.	Bill of materials . . . . .	26
Table 9.	Winding characteristics . . . . .	31
Table 10.	Document revision history . . . . .	36

## List of figures

Figure 1.	STEVAL- ISA057V1	1
Figure 2.	Electrical diagram	6
Figure 3.	ESBT - internal schematic and symbol	7
Figure 4.	$V_{IN} = 125$ VDC and maximum output power in steady-state conditions	10
Figure 5.	$V_{IN} = 125$ VDC and no output power (no load) in steady-state conditions	11
Figure 6.	$V_{IN} = 125$ VDC and maximum output power in steady-state conditions - switch-ON highlighted	11
Figure 7.	$V_{IN} = 125$ VDC and maximum output power in steady-state conditions - switch-OFF highlighted	12
Figure 8.	620 VDC and maximum output power in steady-state conditions	12
Figure 9.	620 VDC and no output power (no load) in steady-state conditions	13
Figure 10.	620 VDC and maximum output power in steady-state conditions - switch-ON highlighted	13
Figure 11.	620 VDC and maximum output power in steady-state conditions - switch-OFF highlighted	14
Figure 12.	1250 VDC and maximum output power in steady-state conditions	14
Figure 13.	1250 VDC and no output power (no load) in steady-state conditions	15
Figure 14.	1250 VDC and maximum output power in steady-state conditions - switch-ON highlighted	15
Figure 15.	1250 VDC and maximum output power in steady-state conditions - switch-OFF highlighted	16
Figure 16.	Efficiency versus output power at $V_{IN} = 125$ VDC	17
Figure 17.	Efficiency versus output power at $V_{IN} = 500$ VDC	18
Figure 18.	Efficiency versus output power at $V_{IN} = 1000$ VDC	18
Figure 19.	Connector description	21
Figure 20.	Startup at 125 VDC	21
Figure 21.	Power-down at 125 VDC	22
Figure 22.	Short-circuit test at $V_{IN} = 125$ VDC	23
Figure 23.	Short-circuit test at $V_{IN} = 620$ VDC	23
Figure 24.	Short-circuit test at $V_{IN} = 1250$ VDC	24
Figure 25.	Silk screen - top side	28
Figure 26.	Silk screen - bottom side	28
Figure 27.	Copper tracks - top side	29
Figure 28.	Copper tracks - bottom side	29
Figure 29.	Electrical diagram of the transformer	30
Figure 30.	Winding position	31
Figure 31.	Hole arrangement	32

## 2 Adapter features

### 2.1 Main characteristics

The following is a list of the specifications and main parameters of the demonstration board.

- Minimum input voltage: 125 VDC
- Maximum input voltage: 1250 VDC
- Output voltage: 5 V - 3.0 A
- Maximum output power: 15 W
- Short-circuit protection based on auto-restart feature
- Minimum switching frequency limited to 30 kHz
- Overall converter efficiency > 60%
- Non-galvanic isolated solution used in most metering applications
- PCB type and size:
  - material used for PCB: FR-4
  - double-sided layout
  - thickness of copper: 35  $\mu$ m
  - total diameter of demonstration board: 58 x 120 mm.

### 2.2 Circuit description

This device is a flyback converter, a very popular and well-known topology in switch-mode power supply applications where the required output power is in the range of 5 to 200 W. The popularity of this type of converter comes from the simplicity of its design, the small number of components and its resulting low cost compared to other topologies in the same output power range.

The converter is based on the L6565 PWM driver that operates in quasi-resonant mode, meaning zero voltage or valley switching during the turn-OFF phase. Current mode control is the primary control method. An ESBT switch must be used for this application. The ESBT is a cascade configuration of a high-voltage bipolar junction transistor (BJT) and a low-voltage power MOSFET. STMicroelectronics™ optimizes the performance of both devices and offers this kind of switch in one single package so as to simplify the application's design, reduce electromagnetic interference and price, and increase reliability and performance (see [Figure 3](#)). The ESBT switch, compared to a high-voltage switch, offers a low ON-state voltage drop like a BJT. The switch is very robust, easy to drive and has a relatively fast switching speed similar to that of a MOSFET.

For more detailed information on the design of the discontinuous conduction-mode flyback converter, refer to the application note AN1889 "*ESBT STC03DE170HV in 3-phase auxiliary power supply*".

Figure 2. Electrical diagram

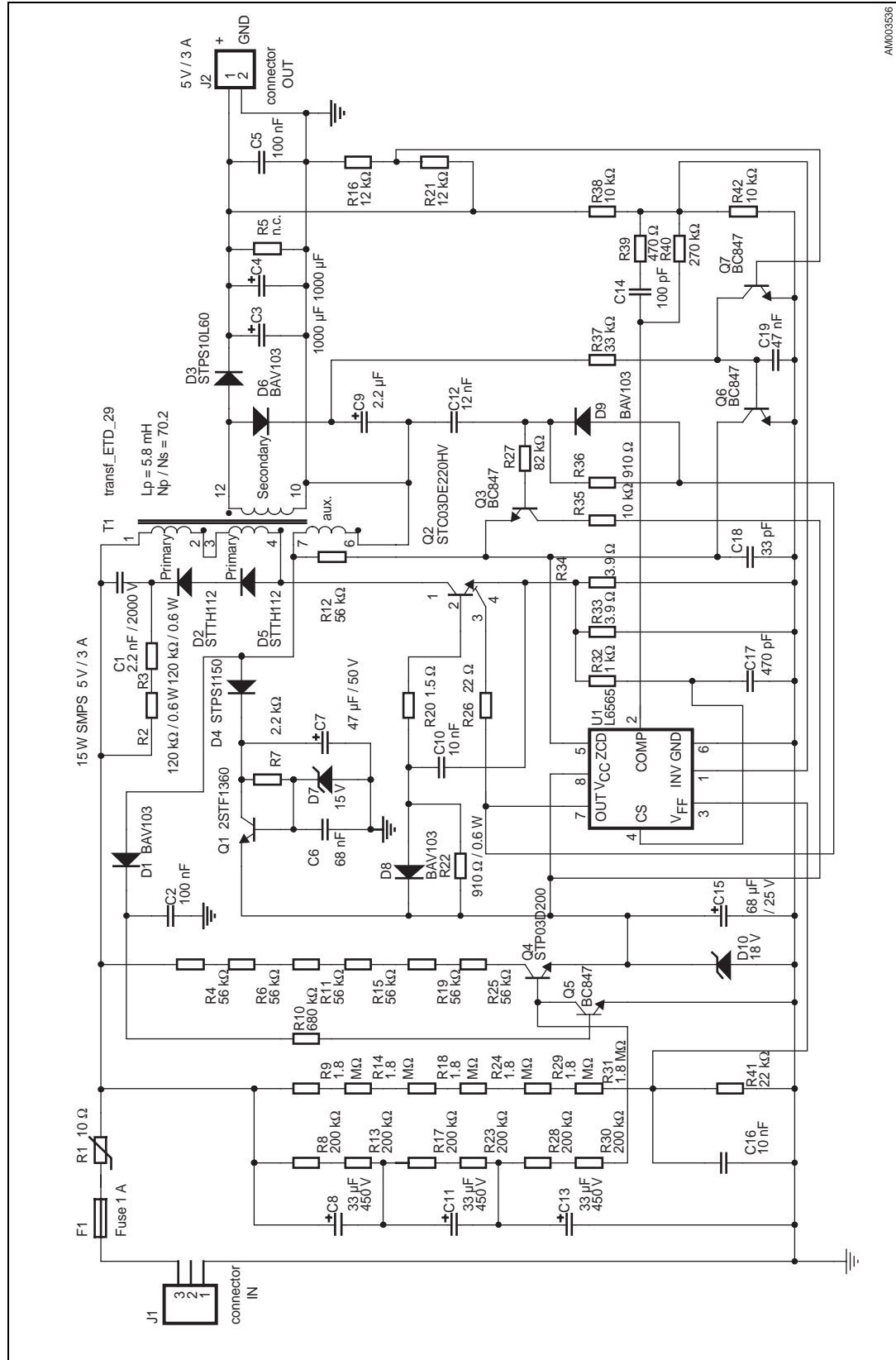

AM003536

The operational voltage of the converter ranges from 125 to 1250 VDC, which enables the demonstration board to be used in various technologies, particularly in metering applications. The output voltage is 5 V and the maximum output power is 15 W.

The board is protected with a 1-A fuse in the primary area. A negative temperature coefficient (NTC) resistor is inserted in series with the input line to protect the demonstration board from inrush current. For voltage purposes on the input DC line, the main 450 V filtering capacitors are connected in series.

**Figure 3. ESBT - internal schematic and symbol**

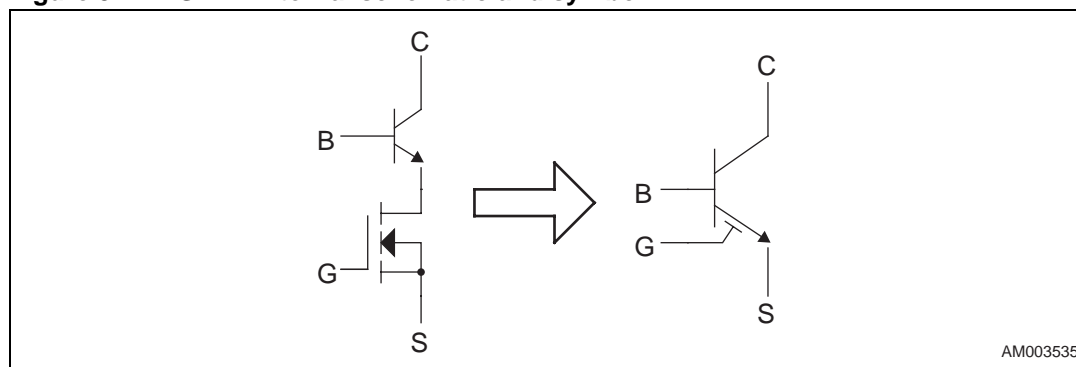

A non-dissipative active startup circuit has been implemented to optimize the converter's efficiency. The alternative option of using a pure resistive startup circuit was rejected due to unacceptable power losses. The active startup circuit has been designed with Q4, Q5 and related passive parts. The R4, R6, R11, R15, R19 and R25 resistors provide the supply current to the PWM driver during the start-up phases and have been calculated from the minimal input supply voltage of the converter and required supply current of the PWM controller L6565, plus the related supply current required to charge the C15 filtering capacitor within a reasonable time to maintain an acceptable startup time. The balance resistors R8, R13, R17 and R23 are used to ensure the same voltage drop across each input capacitor. R28 and R30 supply the current into the base of the Q4 high-voltage Darlington transistor. When the rising voltage on the C15 capacitor reaches the start-up threshold of the L6565 PWM controller, the voltage on the transformer's auxiliary winding turns on the Q5 transistor, which in turn shorts the base of the Q4 transistor. This means that the active startup is blocked. The main power dissipation under normal working conditions of the startup circuit is due to the balance resistors. Refer to AN2454 "*Universal input voltage power supply for ESBT-based breaker and metering applications*" for more information on active startup issues.

The self-supply circuit that provides the supply energy to the controller has been built around Q1, which acts as a linear voltage regulator. This voltage regulator offers a stable output supply voltage, which guarantees the performance of the converter's overall input voltage range at very low or no loads. The voltage regulator is mandatory in such applications with a wide input voltage range. The value of the auxiliary voltage is set with the Zener diode D7 and is approximately 14.5 V. The primary side of the converter incorporates the L6565 PWM controller that includes all the features required for building a complete system working in QR mode with a minimal number of external components.

Information relating to the zero voltage switching comes from the transformer's auxiliary winding. The auxiliary winding is also used for the controller's self-supply. To keep a relatively constant output power across the entire input voltage range, the line voltage is fed through resistors R9, R14, R18, R24, R29 and R31 into the line voltage feed-forward pin ( $V_{FF}$ ) of the L6565.

This information is used to change the set point of the pulse-by-pulse current limitation. In the standard application circuit with L6565 as U1, an OFF-time limitation circuit with a Q3 transistor has been added. This transistor limits the maximum switching frequency of the converter to approximately 70 kHz. The input information coming from the OUT pin is fed into Q3 with a delay. This feature provides some anticipated time during the OFF time by blocking the ZCD pin of the converter, and enables the reflected voltage on the auxiliary winding to be sensed after that time. This means that the controller has skipped one or several valleys of the flyback voltage during the turn-OFF phases and has limited the maximum switching frequency. The circuit's time constant is set with capacitor C12 and resistor R36. The limitations of the application's frequency keep power losses on the primary ESBT switch within reasonable values and contribute to the converter's overall stability. Refer to the L6565 datasheet for detailed information on the L6565 and function of the circuit. All features, including the calculation of all setting components, are described in STMicroelectronics' application note AN1326 "*L6565 quasi-resonant controller*". This application note also describes the ZVS concept.

The output voltage is controlled by a non-galvanic isolated primary feedback loop with resistor dividers R38 and R42, and frequency response compensation components R39, R40 and C14. All formulas related to the calculation of the frequency response compensation during first trials and testing in this type of application are described in STMicroelectronics' application note AN2495 "*80 W very wide input voltage range 3-phase SMPS design based on L6565 and ESBT STC04IE170HV*".

In SMPS applications, where the load can vary, the current of the primary switch also fluctuates. To minimize power losses on the ESBT switch, the base current should be proportional to the collector current or at least constant with the initial current overpeak of the switching pulse - this is called the modifying envelope. It is important to avoid radical over-saturation of the device at low loads and aim to optimize performance at full loads. To achieve these driving requirements with a cost-effective solution, a simple driving circuit providing a constant current into the base of the ESBT has been designed. This type of solution is simple, cost-effective and minimizes power losses. The bias current for the base of the ESBT is provided directly by the auxiliary power supply through the R22 resistor. For a related base bias current, the value of this resistor is calculated according to the collector current. According to the STC03DE220HV datasheet, for a maximum peak collector current of 0.6 A, the gain and related base current should be 16 mA. During the storage time, when the collector current for a certain period flows through the B-C junction before this junction recovers from conduction, the current flows into the C10 capacitor which stores some energy and provides it again for the next switching cycle to create an initial base current spike. Current that is not stored can also flow through D8 to the auxiliary supply area. Note that during the storage time the collector current flows through the base and is stored in the base capacitor C10, so that the quasi totality of energy is recovered. The R20 resistor limits the inrush current floating from the C10 capacitor to the base of the Q2 transistor. In this topology, the base current always has the same value and does not follow the variation of the collector current, which appears while unloading the output. The constant base bias current can cause over-saturation of the BJT structure in the ESBT in low- or no-load conditions. However, in a case like this, the driver guarantees the appropriate switching of the ESBT through the ZVS pin when the device is fully switched OFF and the carriers in the BJT are fully recombined. This solution – which is very simple and cost-effective – implies that the ESBT be driven with a constant current.



ESBTs with this type of configuration offer very good performance in terms of power losses, and have a low cost compared to other available switches such as very high voltage power MOSFETs. For further information on driving networks, refer to STMicroelectronics' application note AN2454 "*Universal input voltage power supply for ESBT-based breaker and metering applications*".

The main T1 transformer used is a layered-type transformer, which uses a standard ETD29 core with a bobbin. The ETD29 bobbin has been chosen because of its strong voltage isolation capacities at such high input voltages. In terms of just power requirements, an even smaller core area than the ETD29 could be used. A sandwich topology has been used for the design of the winding, offering better coupling of windings compared to standard topologies with only one primary winding.

This transformer has been designed according to STMicroelectronics' released application notes, with a flyback voltage of 250 V. The turn ratio between the primary and secondary side has been calculated and is approximately 70. Refer to AN1326 "*Quasi-resonant controller*" and AN2495 "*80 W very wide input voltage range 3-phase SMPS design based on L6565 and ESBT STC04IE170HV*" for all necessary calculations.

As is common in flyback applications, the total voltage across the switch can reach very high voltages. The calculation is done with the formula:

$$V_{\text{OFF}} = V_{\text{inmax}} + V_{\text{fl}} + V_{\text{spike}}$$

where  $V_{\text{fl}}$  is the flyback voltage =  $(V_{\text{OUT}} + V_{\text{F diode}}) \times N_{\text{p}}/N_{\text{s}}$ .  $N_{\text{p}}$  is the number of turns on the primary side while  $N_{\text{s}}$  is the number of turns on the secondary side.  $V_{\text{spike}}$  is the maximum overvoltage allowed by the clamping network and has been fixed to 200 V. Allowing for some margin, a related switch STC03DE220HV with a breakdown voltage of 2200 V fills the requirements for these types of application.

A clamp network is used for leakage inductance demagnetization. In this particular case, a C1 capacitor with related passive resistors R2, R3 and blocking diodes D2 and D5 used in series because of voltage stresses, has been selected for this purpose.

The secondary side comprises a Schottky barrier diode D3 as rectifier, and filtering capacitors C3 and C4 featuring low serial resistance. The short-circuit protection features for the converter have been designed with transistors Q7 and Q6 and related passive parts. The Q7 transistor senses the output voltage through the resistor dividers R38 and R42. In normal conditions, the Q7 transistor keeps the Q6 transistor turned off. During a short-circuit condition where the output voltage is very low or equal to zero, the Q7 transistor is closed. Energy stored in the tank capacitor C9 can start to provide the supply current for Q6, which starts to block the function of the converter through the L6565's ZCD pin. This condition continues until all the energy from the C9 capacitor has been discharged. The time cycle is set with the R37 resistor and capacity of C9. Once all the energy in C9 has been discharged, the converter starts to work again. If the short connection on the output is still present, the short-circuit protection repeats until the short circuit is removed.

### 3 Waveforms and results

Figure 4 to Figure 15 show the main waveforms in steady-state conditions, and depict the function of the converter with full loads or no loads and with various input voltages. The figures also show the turn-ON and turn-OFF behavior in various conditions. Of particular interest is the behavior of the base current, where an initial high-peak pulse is needed to minimize the effect of the dynamic saturation voltage.

Figure 4.  $V_{IN} = 125$  VDC and maximum output power in steady-state conditions

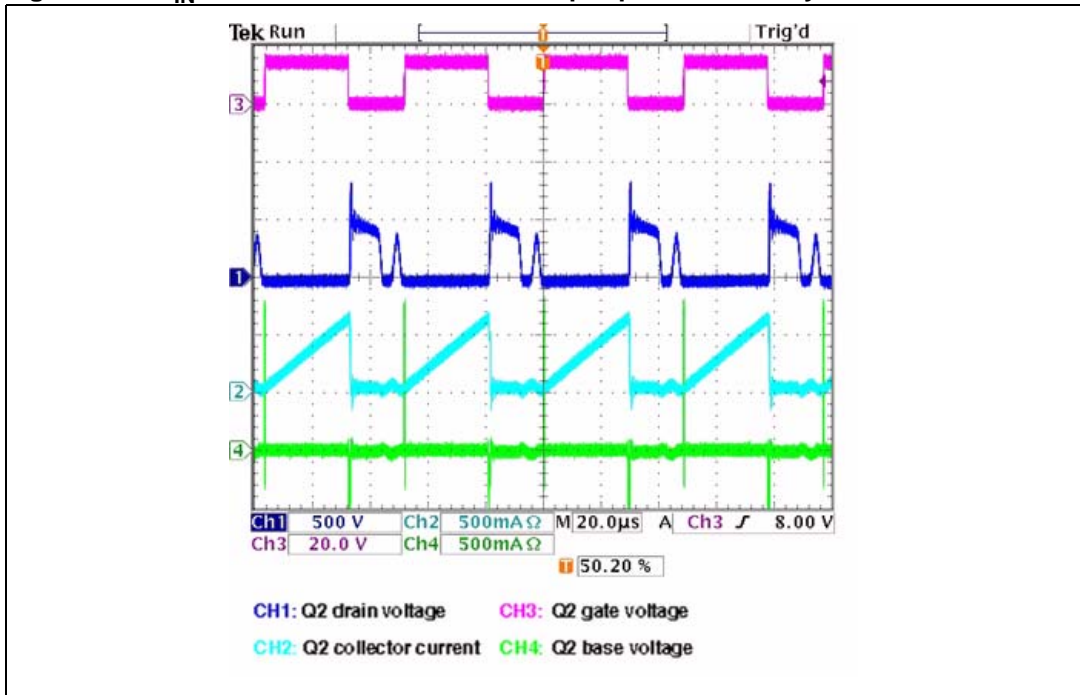

Figure 5.  $V_{IN} = 125$  VDC and no output power (no load) in steady-state conditions

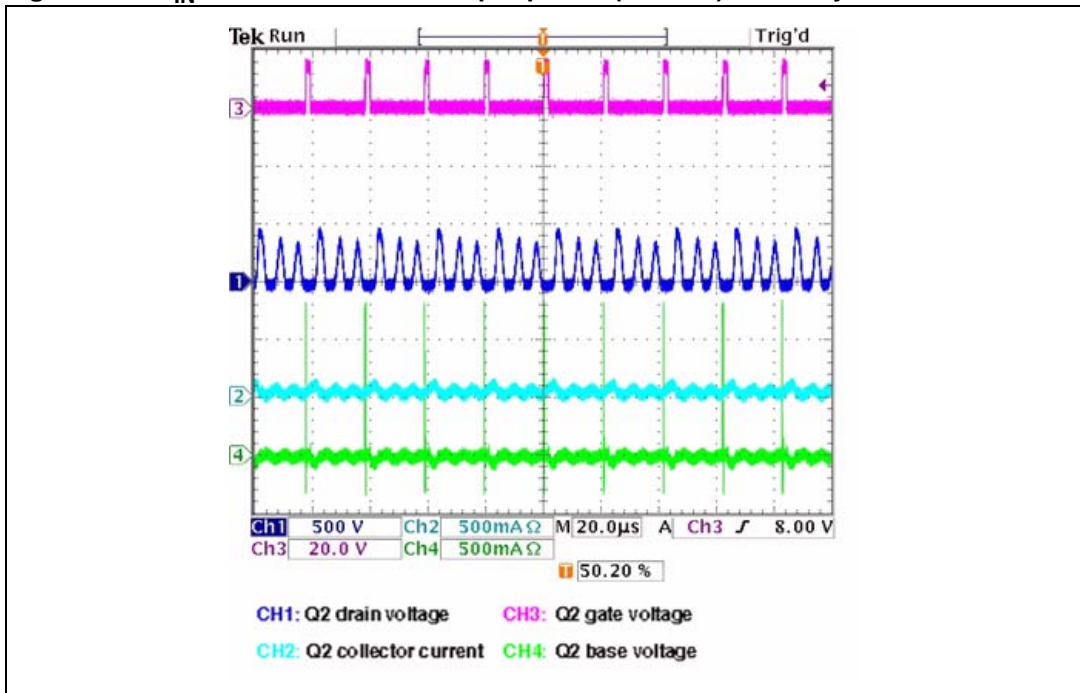

Figure 6.  $V_{IN} = 125$  VDC and maximum output power in steady-state conditions - switch-ON highlighted

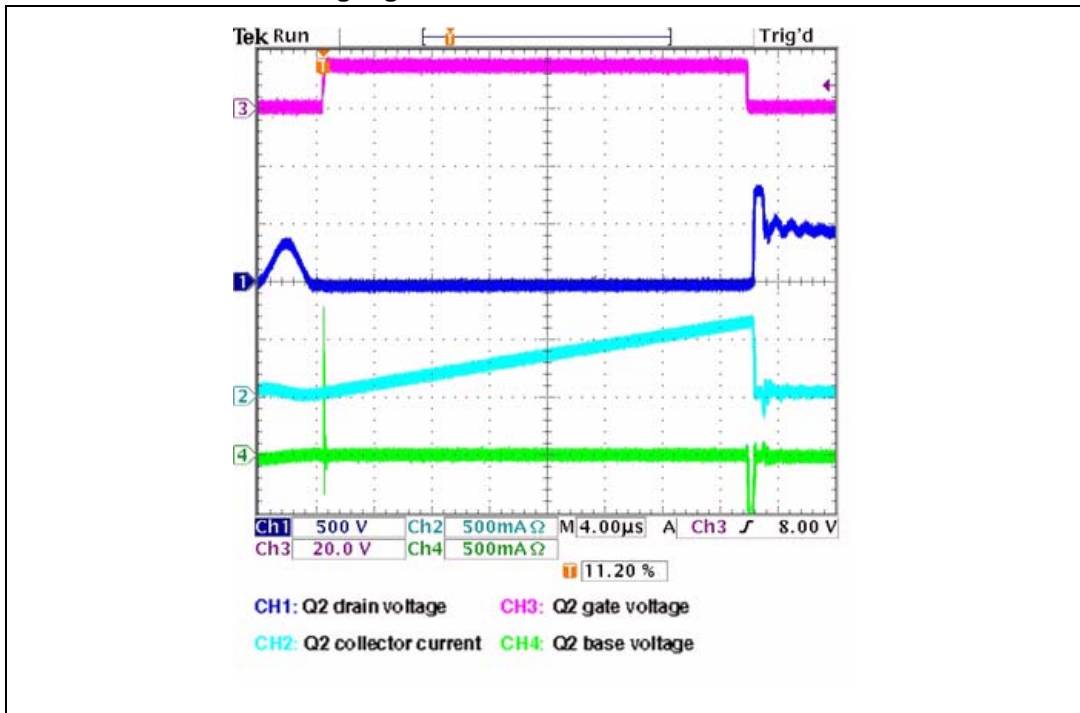

Figure 7.  $V_{IN} = 125$  VDC and maximum output power in steady-state conditions - switch-OFF highlighted

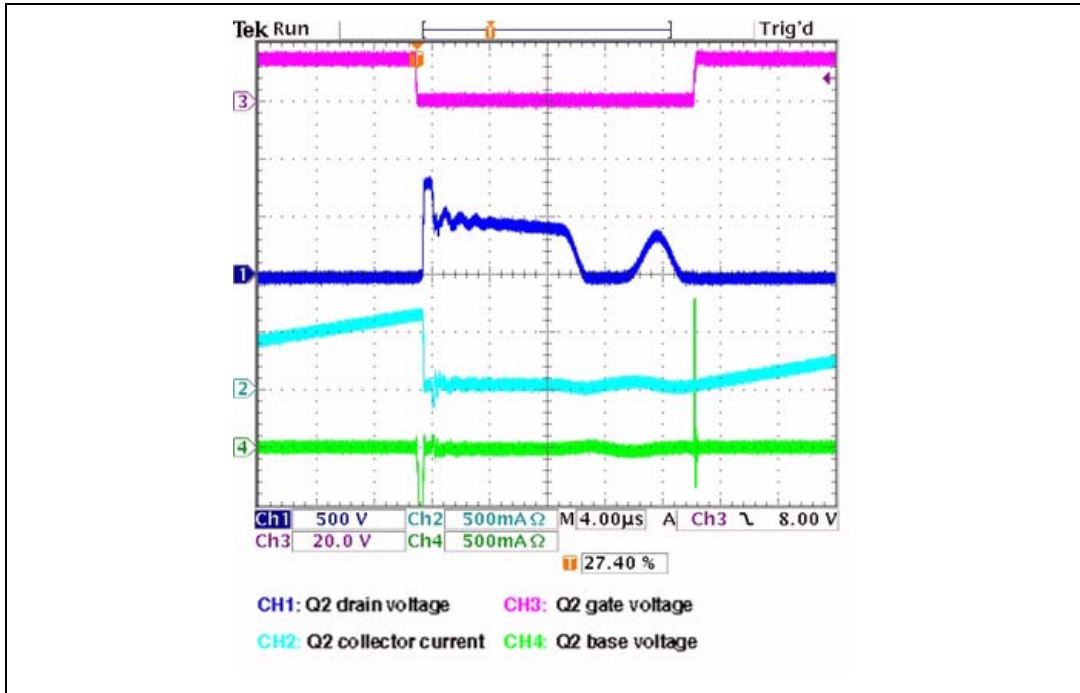

Figure 8. 620 VDC and maximum output power in steady-state conditions

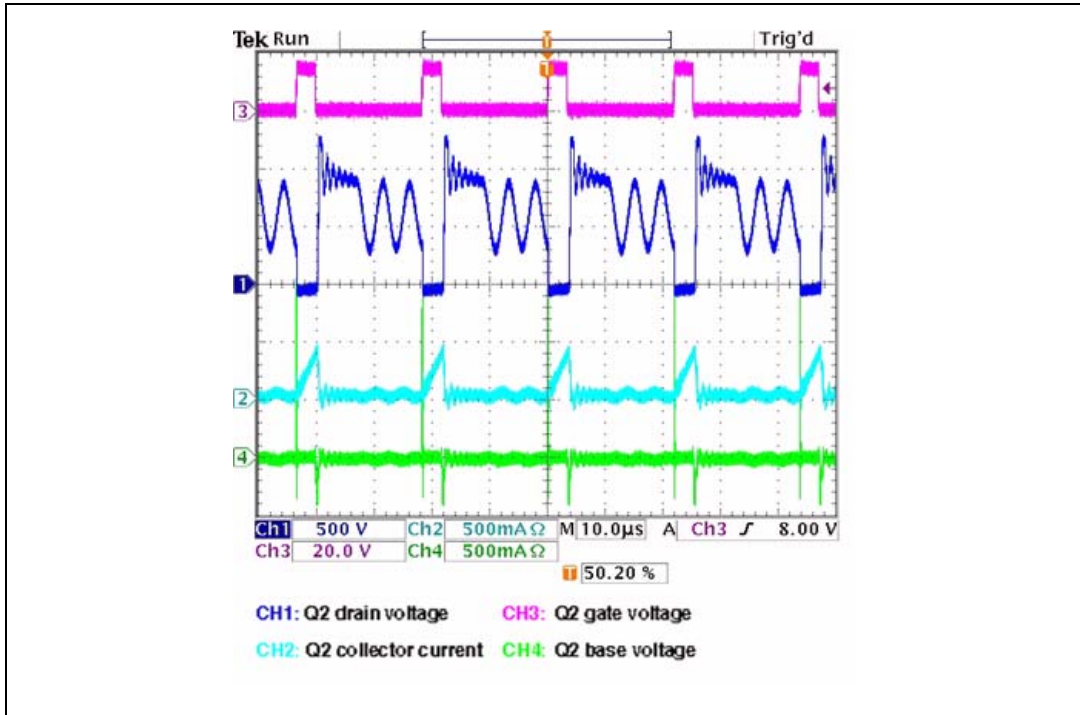

Figure 9. 620 VDC and no output power (no load) in steady-state conditions

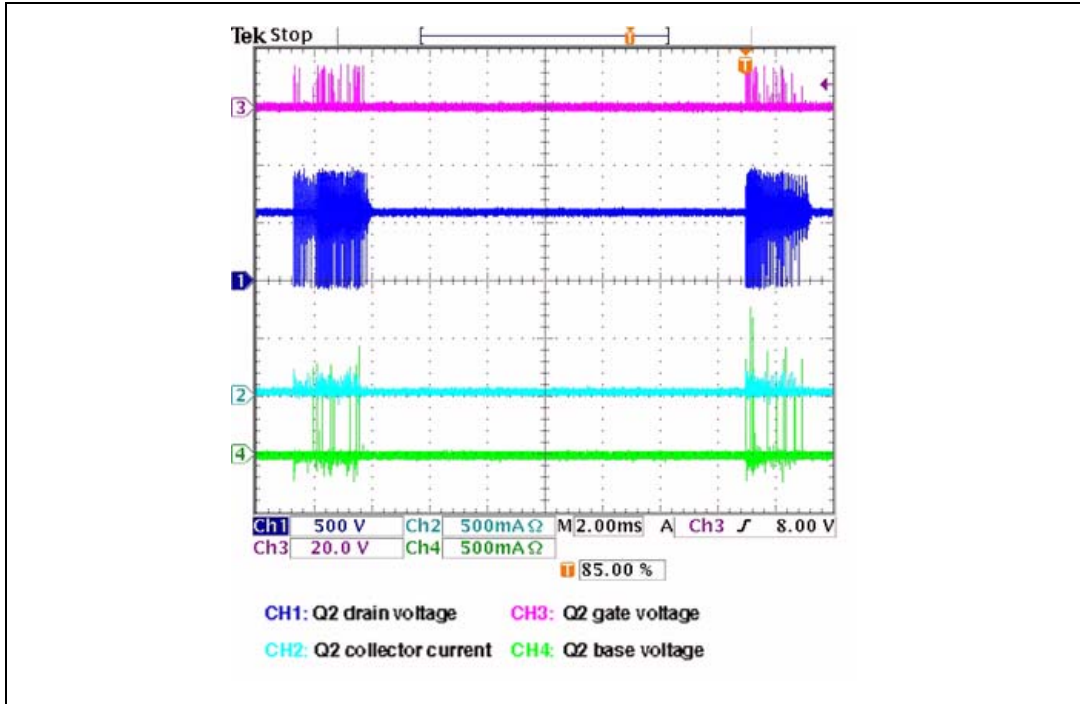

Figure 10. 620 VDC and maximum output power in steady-state conditions - switch-ON highlighted

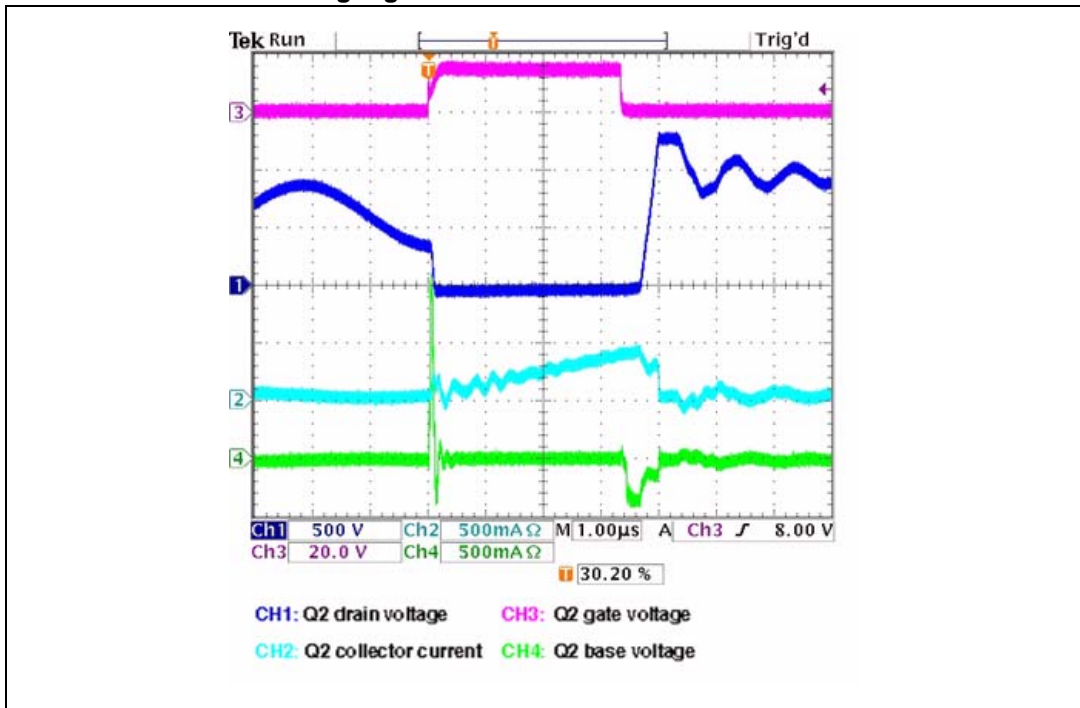



Figure 11. 620 VDC and maximum output power in steady-state conditions - switch-OFF highlighted

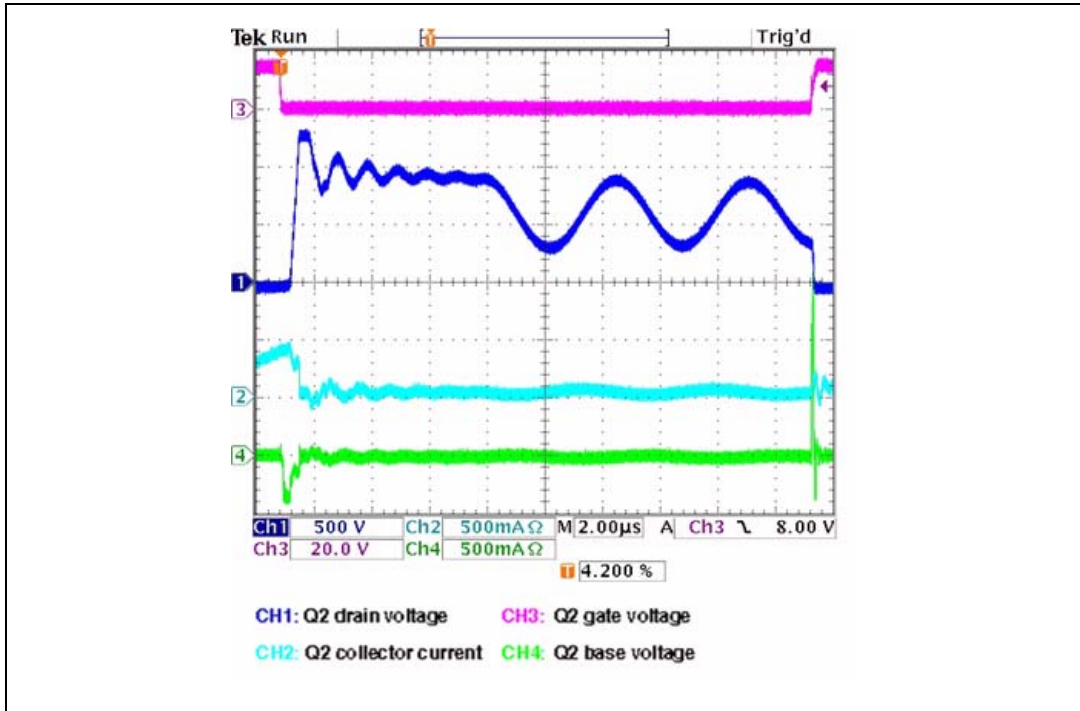

Figure 12. 1250 VDC and maximum output power in steady-state conditions

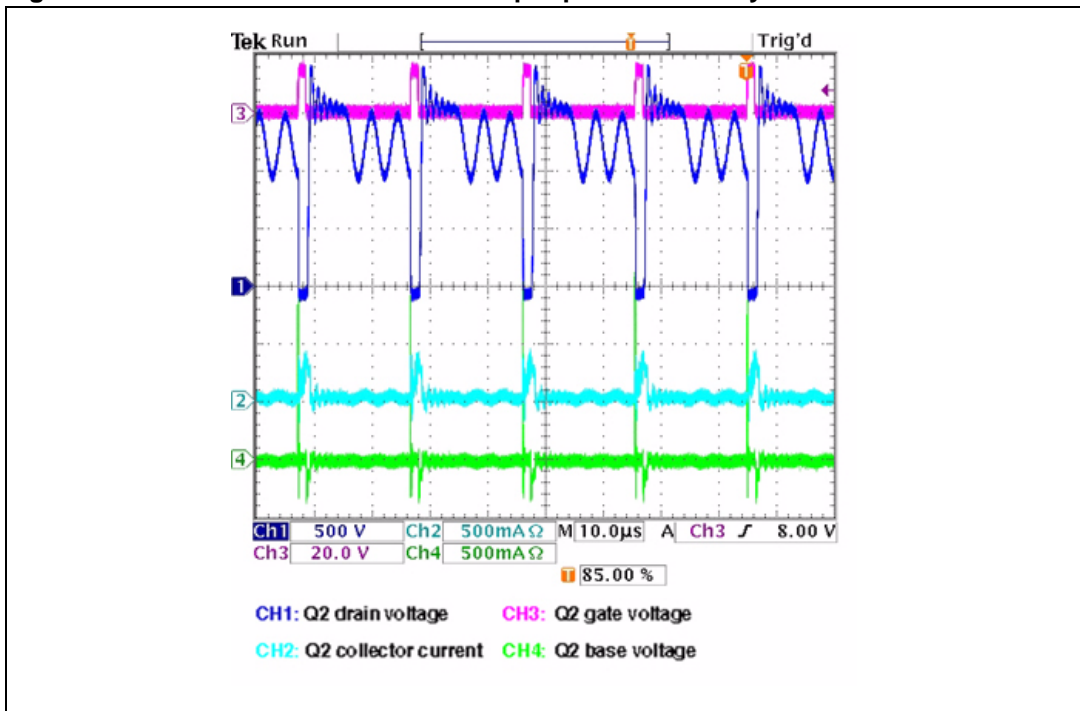

Figure 13. 1250 VDC and no output power (no load) in steady-state conditions

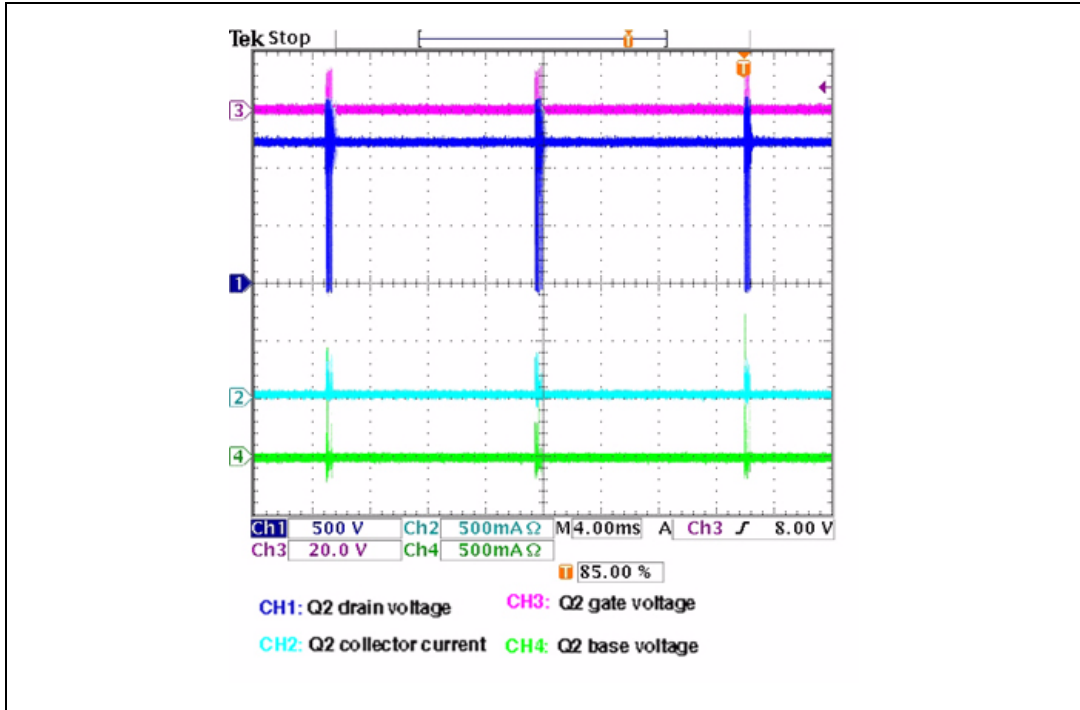

Figure 14. 1250 VDC and maximum output power in steady-state conditions - switch-ON highlighted

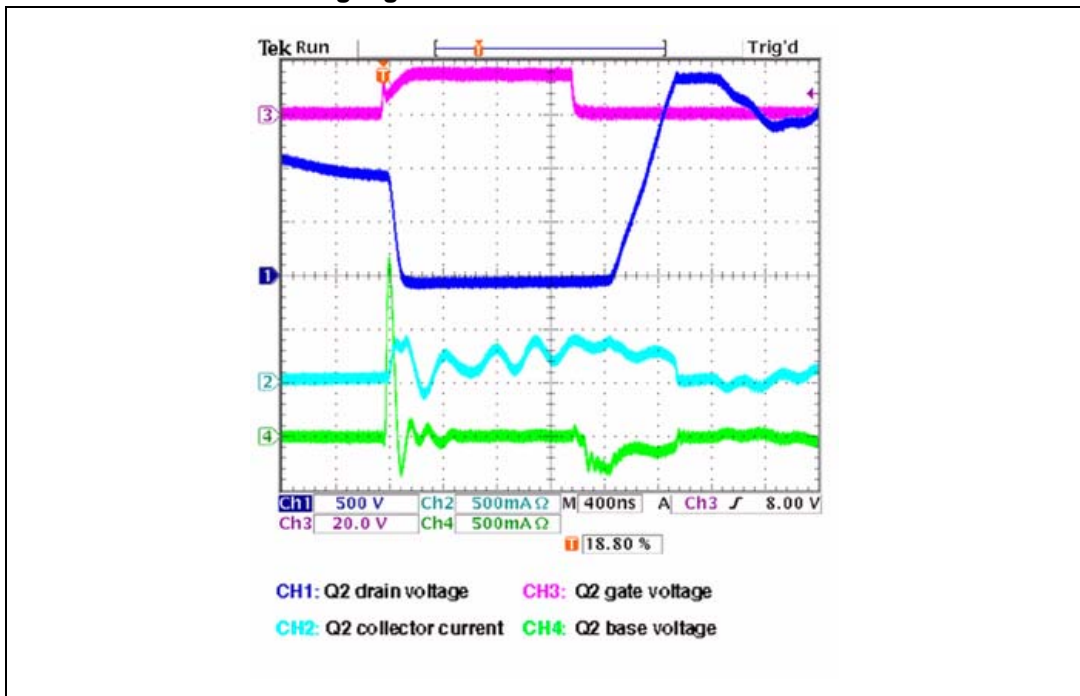
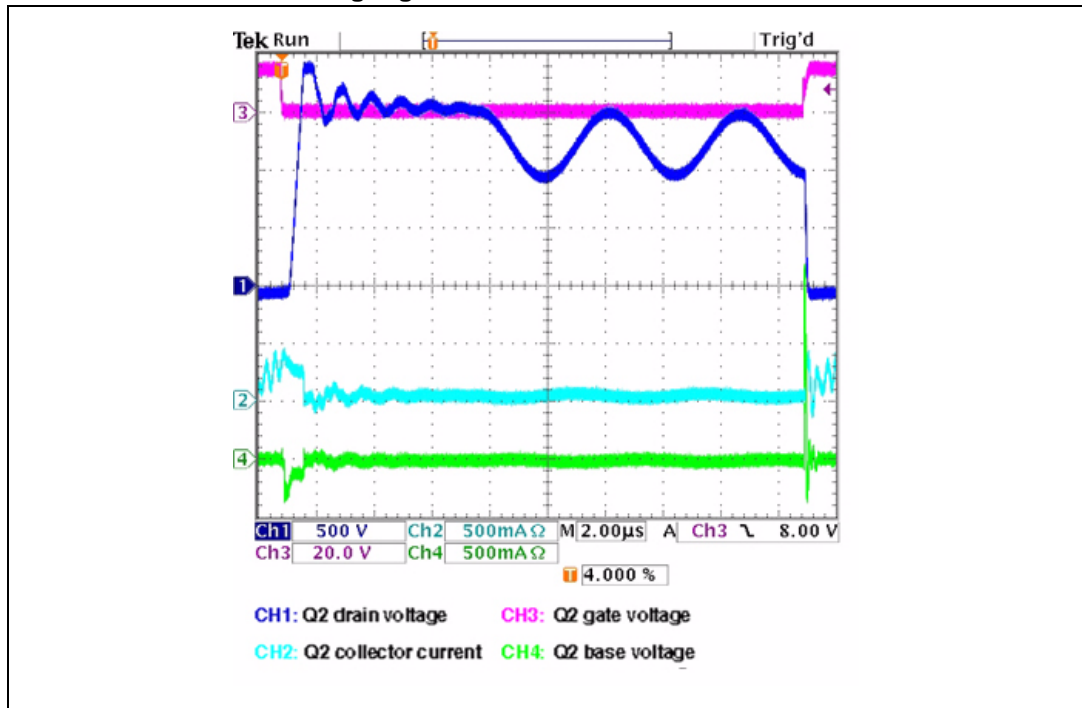

Figure 15. 1250 VDC and maximum output power in steady-state conditions - switch-OFF highlighted





## 4 Electrical performances

*Table 1* shows the output loads for different input voltages. The maximum difference on the output voltage is only about 50 mV.

**Table 1. Line and load regulation**

Output load [A]	Input voltage 125 VDC	Input voltage 620 VDC	Input voltage 1250 VDC
0	5.00	5.01	5.01
0.5	4.99	5.00	5.00
1	4.98	4.99	5.00
1.5	4.97	4.98	4.98
2	4.95	4.97	4.98
3	4.95	4.96	4.97

*Figure 16*, *Figure 17* and *Figure 18* show the converter's efficiency depending on the output load with various input voltage values.

**Figure 16. Efficiency versus output power at  $V_{IN} = 125$  VDC**

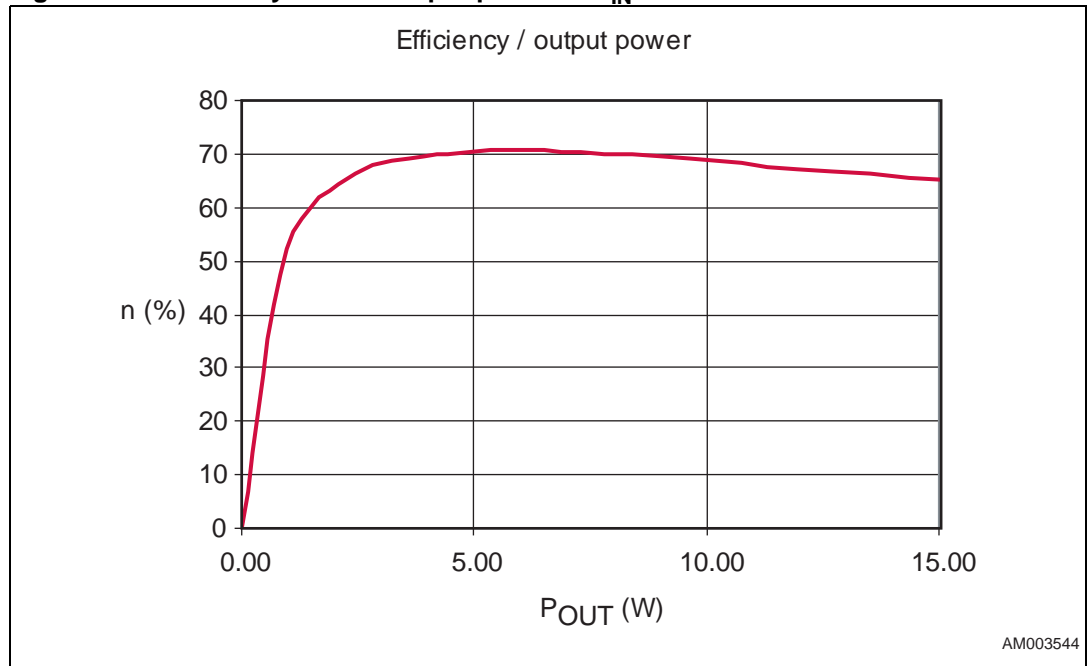

Figure 17. Efficiency versus output power at  $V_{IN} = 500$  VDC

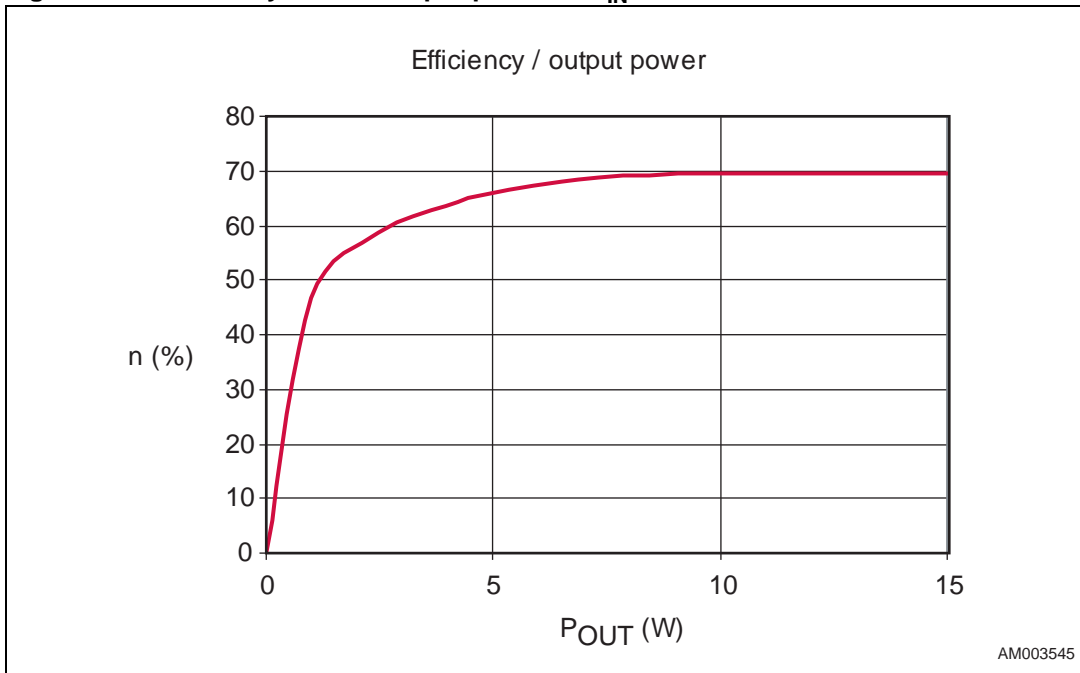
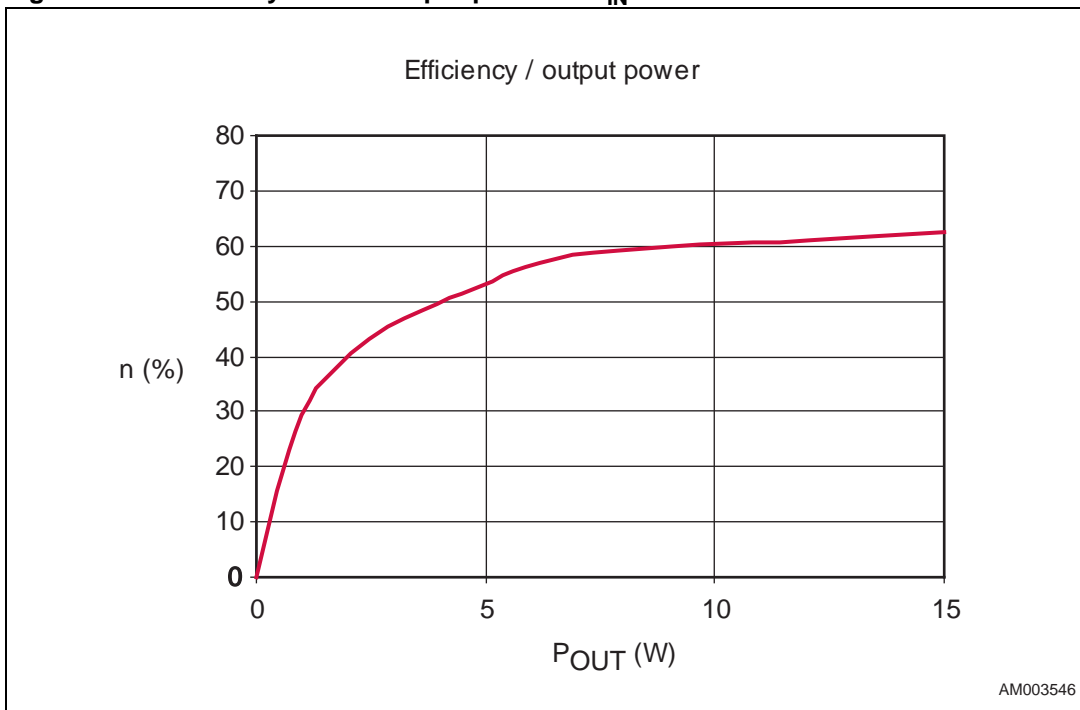

Figure 18. Efficiency versus output power at  $V_{IN} = 1000$  VDC



**Table 2. Efficiency at 125 VDC**

Load [A]	Pin [W]	P <sub>OUT</sub> [W]	Eff [%]
0	0.27	0.00	0.00
0.2	1.85	0.97	52.43
0.5	3.70	2.45	66.22
0.8	5.62	3.91	69.57
1	6.94	4.88	70.32
1.2	8.27	5.84	70.62
1.5	10.31	7.27	70.51
2	13.94	9.64	69.15
2.5	17.80	11.96	67.19
3	21.93	14.28	65.12

**Table 3. Efficiency at 500 VDC**

Load [A]	Pin [W]	P <sub>OUT</sub> [W]	Eff [%]
0	0.47	0	0.00
0.2	2.07	0.97	46.86
0.5	4.2	2.46	58.57
0.8	6.19	3.94	63.65
1	7.44	4.9	65.86
1.2	8.7	5.87	67.47
1.5	10.62	7.31	68.83
2	13.89	9.68	69.69
2.5	17.2	11.99	69.71
3	20.57	14.3	69.52

**Table 4. Efficiency at 1000 VDC**

Load [A]	Pin [W]	P <sub>OUT</sub> [W]	Eff [%]
0	1.5	0	0.00
0.2	3.31	0.97	29.31
0.5	5.68	2.46	43.31
0.8	7.99	3.94	49.31
1	9.4	4.91	52.23
1.2	10.49	5.88	56.05
1.5	12.45	7.33	58.88
2	16.37	9.69	59.19
2.5	19.66	12.03	61.19
3	22.94	14.33	62.47

[Table 5](#) shows the device's power consumption in no-load conditions.

**Table 5. Power consumption in no-load conditions**

	$V_{IN} = 125 \text{ VDC}$	$V_{IN} = 500 \text{ VDC}$	$V_{IN} = 1000 \text{ VDC}$
Pin [W]	0.27	0.47	1.50

This board has been designed to work in continuous cycles even with no loads. The reason for this is an improved transfer response of the circuit, a lower output ripple and enhanced stability of the converter.

The switching frequency of the ZVS control method used with the L6565 varies according to the load and input voltage. This behavior has a positive impact on the switching losses mainly in low-load conditions where the switching frequency rises dramatically to 60 kHz, the maximum frequency that the application can tolerate.

## 5 Functional check

Figure 19 shows the placement of the input and output connectors on the PCB.

Figure 19. Connector description

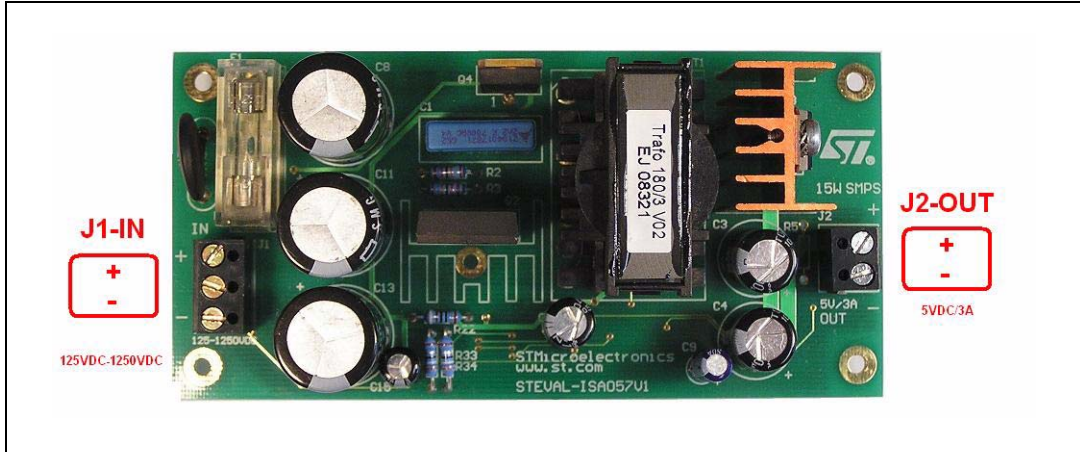

The following sections describe the main functional parameters of the board.

### 5.1 Startup behavior at full loads

Figure 20 shows the board's startup behavior at full loads.

Figure 20. Startup at 125 VDC

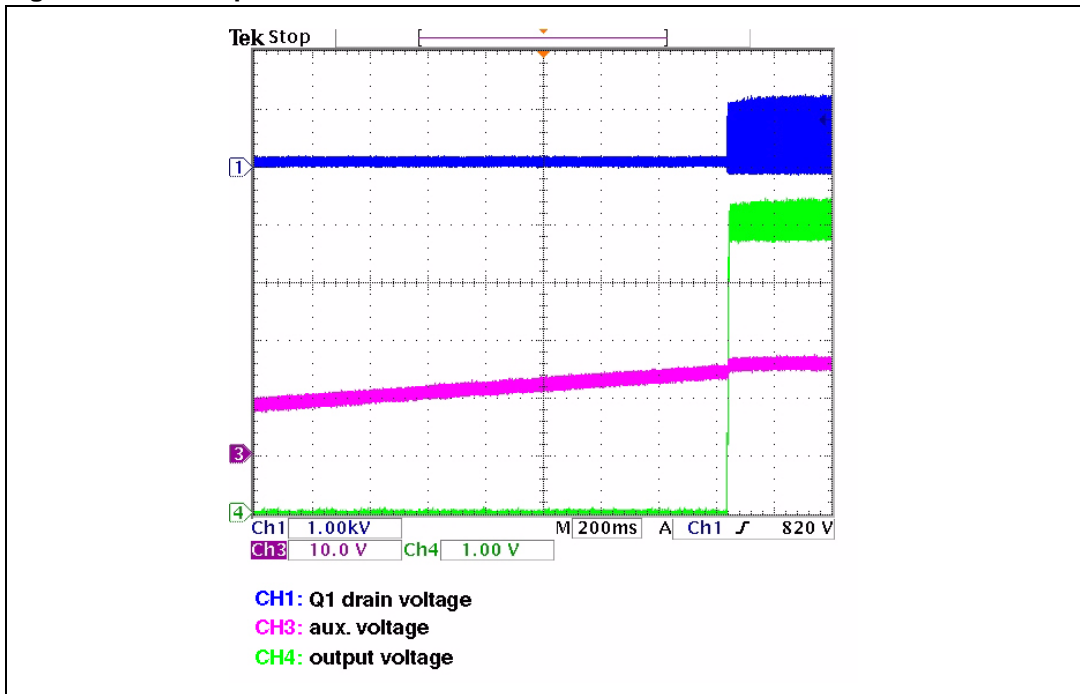

## 5.2 Power-down

Figure 21 shows the reaction of the board when it is unplugged from the mains. The output voltage as well as the auxiliary self-supply voltage have clear transitions with no glitches or restart trials.

Figure 21. Power-down at 125 VDC

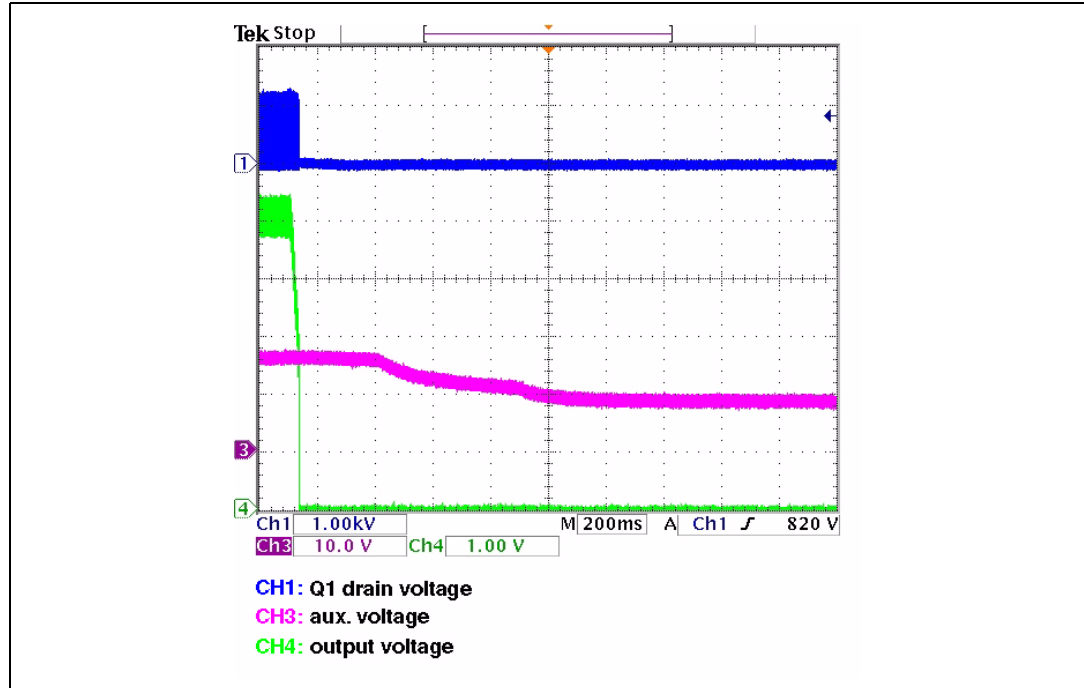

## 5.3 Short-circuit tests

The following figures depict the board's behavior when a short circuit occurs on the output connector. Throughout the duration of a short-circuit condition, the output voltage is sensed through logic circuits which contain Q6 and Q7 and the L6565 driver is shut down through pin 5. Once all the energy from the C9 capacitor has been discharged, a logical stop reacts on the output voltage and the board starts to operate normally. If the short-circuit condition persists, the whole cycle repeats until the short-circuit condition stops. When a short-circuit connection is removed, the converter starts to operate normally again.

Figure 22. Short-circuit test at  $V_{IN} = 125\text{ VDC}$

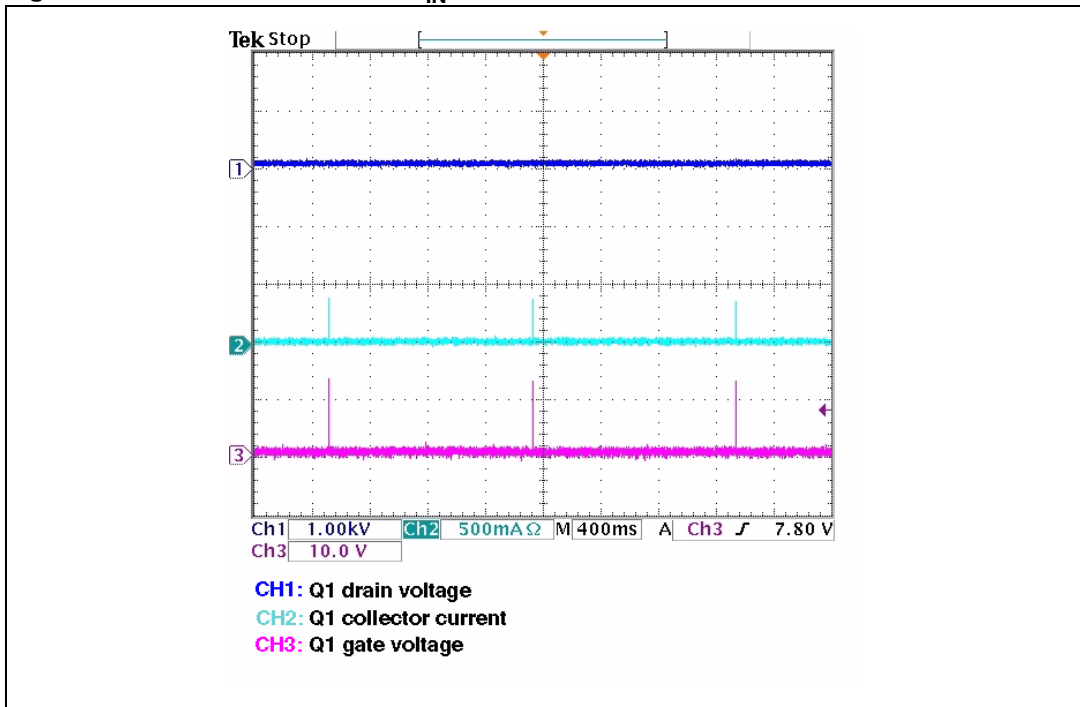

Figure 23. Short-circuit test at  $V_{IN} = 620\text{ VDC}$

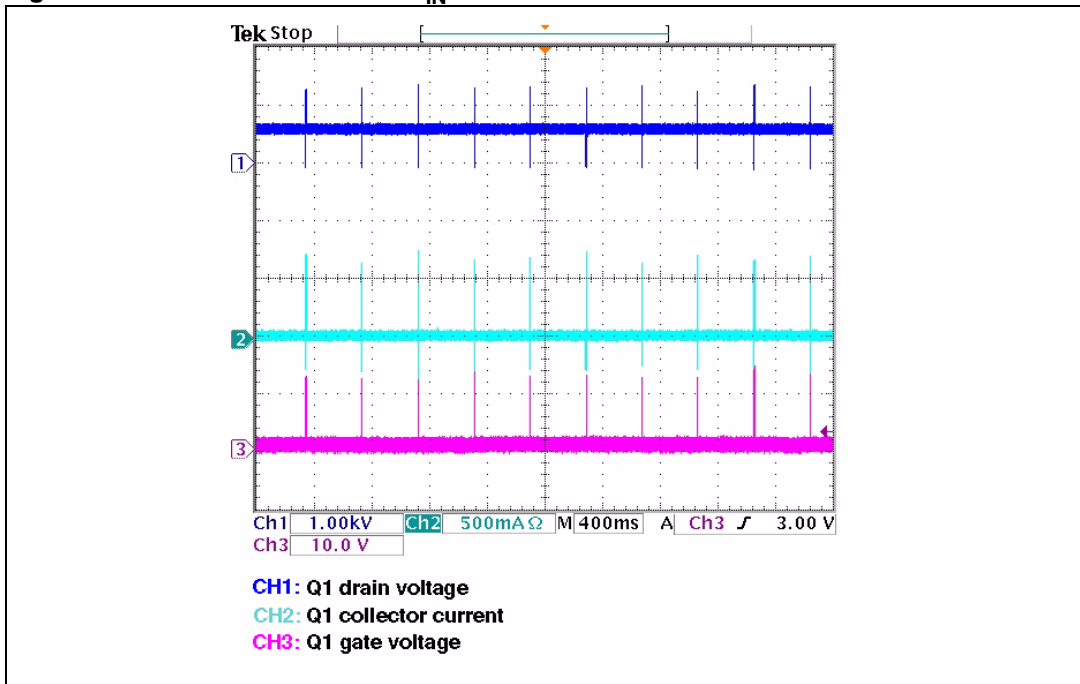
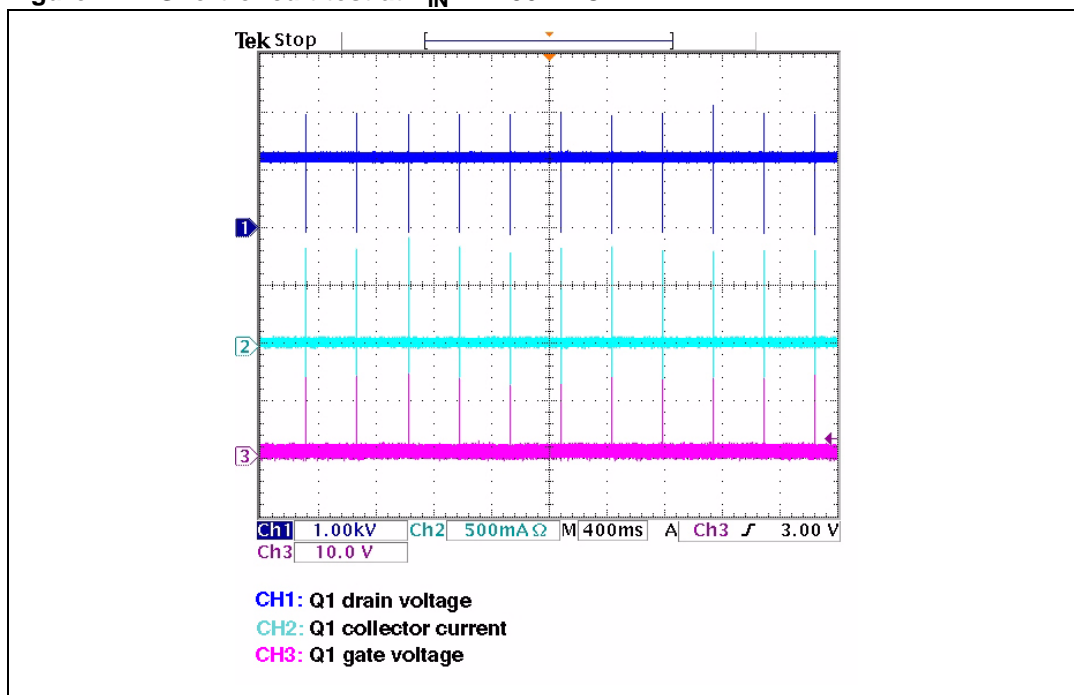

Figure 24. Short-circuit test at  $V_{IN} = 1250$  VDC





## 6 Thermal measurements

A thermal analysis of the major components of the board is shown in [Table 6](#) and [Table 7](#). All measurements were performed after one hour of operation.

$T_A$ : the ambient temperature for all measurements is 25 °C.

**Table 6. Temperature of key components at 125 VDC - full load  
(3 A output current)**

Ref.	Component description	Temperature [°C]
R2	NTC	35
D2	Clamp resistors (R2; R3)	35
Q1	ESBT switch STC03DE220HV	37
U1	L6565	35
T1	Transformer - ferrite	44
T1	Transformer - windings	65
Q2	Output diode	80
C12/C13	Bulk capacitors	35

**Table 7. Temperature of key components at 1250 VDC - low load  
(3 A output current)**

Ref.	Component description	Temperature [°C]
R2	NTC	35
D2	Clamp resistors (R2; R3)	45
Q1	ESBT switch STC03DE220HV	75
U1	L6565	35
T1	Transformer - ferrite	48
T1	Transformer - windings	55
Q2	Output diode	73
C12/C13	Bulk capacitors	35

## 7 Bill of materials

[Table 8](#) presents the list of components used to build the demonstration board. The majority of components used are available from STMicroelectronics. The main transformer is supplied by EGSTON GmbH.

**Table 8. Bill of materials**

Index	Quantity	Reference	Value/generic part number	Package/class	Manufacturer
1	1	C1	2.2 nF / 700 VAC	AXIALcap-RM 15 mm	EPCOS
2	1	C2	100 nF	Capacitor, SMD 0805	AVX
3	2	C3, C4	1000 $\mu$ F / 10 V	Elyt. capacitor, radial, RM 5 mm	Rubycon
4	1	C5	100 nF	Capacitor, SMD 0805	AVX
5	1	C6	68 nF	Capacitor, SMD 0805	AVX
6	1	C7	47 $\mu$ F / 50 V	Capacitor, SMD 0805	Rubycon
7	3	C8, C11, C13	33 $\mu$ F / 450 V	Elyt capacitor, radial, RM 7.5 mm	Rubycon
8	1	C9	2.2 $\mu$ F / 10 V	Elyt capacitor, radial, RM 2.5 mm	Rubycon
9	1	C10	10 nF	Capacitor, SMD 0805	AVX
10	1	C12	12 nF	Capacitor, SMD 0805	AVX
11	1	C14	100 pF	Capacitor, SMD 0805	AVX
12	1	C15	68 $\mu$ F / 25 V	Elyt capacitor, radial, RM 2.5 mm	Rubycon
13	1	C16	10 nF	Capacitor, SMD 0805	AVX
14	1	C17	470 pF	Capacitor, SMD 0805	AVX
15	1	C18	33 pF	Capacitor, SMD 0805	AVX
16	1	C19	47 nF	Capacitor, SMD 0805	AVX
17	1	R1	10 $\Omega$	NTC resistor; RM 7.5 mm	EPCOS
18	2	R2, R3	120 k $\Omega$	Resistor 0207; 0.6 W	Vishay™
19	6	R4, R6, R11, R15, R19, R25,	56 k $\Omega$	Resistor, SMD 1206	Vishay
20	1	R5	Not connected	Resistor 0207; 0.6 W	Vishay
21	6	R8, R13, R17, R23, R28, R30	200 k $\Omega$	Resistor, SMD 1206	Vishay
22	6	R9, R14, R18, R24, R29, R31	1.8 M $\Omega$	Resistor, SMD 1206	Vishay
23	1	R10	680 k $\Omega$	Resistor, SMD 0805	Vishay
24	1	R7	2.2 k $\Omega$	Resistor, SMD 0805	Vishay
25	1	R12	56 k $\Omega$	Resistor, SMD 0805	Vishay
26	2	R16, R21	12 k $\Omega$	Resistor, SMD 0805	Vishay
27	1	R22	910 $\Omega$	Resistor 0207; 0.6 W	Vishay

Table 8. Bill of materials (continued)

Index	Quantity	Reference	Value/generic part number	Package/class	Manufacturer
28	1	R26	22 $\Omega$	Resistor, SMD 0805	Vishay
29	1	R20	1.5 $\Omega$	Resistor, SMD 1206	Vishay
30	1	R27	82 k $\Omega$	Resistor, SMD 0805	Vishay
31	1	R41	22 k $\Omega$	Resistor, SMD 0805	Vishay
32	1	R32	1 k $\Omega$	Resistor, SMD 0805	Vishay
33	2	R33, R34	3.9 $\Omega$	Resistor 0207; 0.6 W	Vishay
34	1	R35	10 k $\Omega$	Resistor, SMD 0805	Vishay
35	1	R36	910 $\Omega$	Resistor, SMD 0805	Vishay
36	1	R37	33 k $\Omega$	Resistor, SMD 0805	Vishay
37	1	R39	470 $\Omega$	Resistor, SMD 0805	Vishay
38	1	R40	270 k $\Omega$	Resistor, SMD 0805	Vishay
39	2	R38, R42	10 k $\Omega$	Resistor, SMD 0805, 1%	Vishay
40	4	D1, D6, D8, D9	BAV103	Diode, miniMELF	Vishay
41	1	D4	STPS1150A	Diode, DO-214AC	STMicroelectronics
42	2	D2, D5	STTH112A	HV diode, SMA	STMicroelectronics
43	1	D3	STPS10L60D	Power Schottky rectifier, TO-220AC	STMicroelectronics
44	1	D7	BZV55C15SMD	Zener diode, SOD80, 15 V	Vishay
45	1	D10	BZV55C18SMD	Zener diode, SOD80, 18 V	Vishay
46	1	Q1	2STF1360	NPN transistor, SOT-89	STMicroelectronics
47	1	Q2	STC03DE220HV	ESBT, TO247-4L HV	STMicroelectronics
48	4	Q3, Q5, Q6, Q7	BC847	NPN transistor, SOT-23	FAIRCHILD
49	1	Q4	STP03D200	NPN Darlington, TO-220	STMicroelectronics
50	1	U1	L6565D	PWM smart driver, SO-8	STMicroelectronics
51	1	F1	Fuse 1 A	Fuse with holder, 1 A, slow	
52	1	J1		Connector ARK	ARK
53	1	J2	ARK210/5 mm	Connector ARK	ARK
54	2	T1	EGSTON 39663	Transformer EGSTON ETD29 core	EGSTON
55	2	Het1, Het2	V7142A	Heatsink V7142A	PADA Engineering



Figure 27. Copper tracks - top side

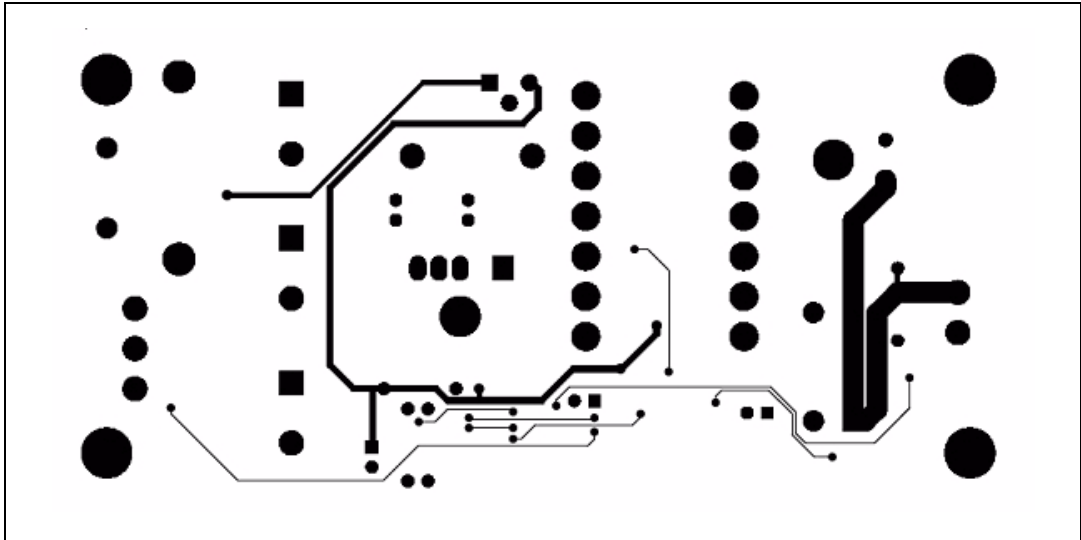
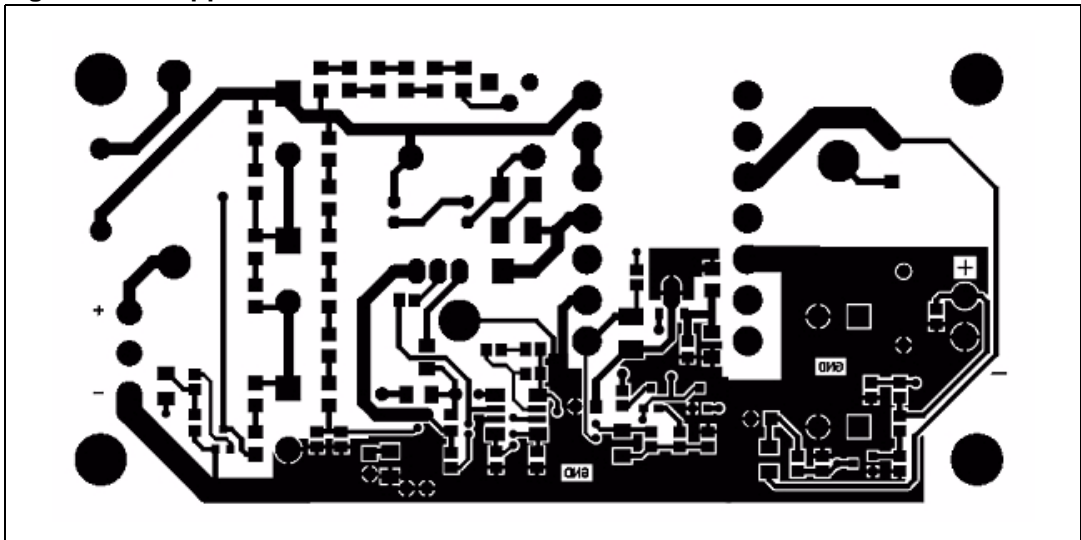

Figure 28. Copper tracks - bottom side



## 9 Transformer specification

- Application type: customer, home appliances
- Winding type: layer
- Coil former: vertical type - 14 pins
- Material of coil former: GFR thermostatic plastic UL 94 V-0
- Maximum temperature increase: 45° C
- Maximum operating ambient temperature: 60° C
- Mains insulation: according to EN60950

### 9.1 Electrical characteristics

- Converter topology: flyback working in boundary mode
- Minimum switching frequency: > 32 kHz
- $L_p = 5.8$  mH
- $N_p/N_s = 70.2$
- Reflected flyback voltage: 400 VDC
- Core type: ETD29 - EPCOS
- Core material: N87 from EPCOS or similar
- Air gap: 0.60 mm

The design of the related power transformer has been further optimized by EGSTON System Electronics Eggenburg GmbH, manufacturer of the transformer. The ordering type is 39663.

**Figure 29. Electrical diagram of the transformer**

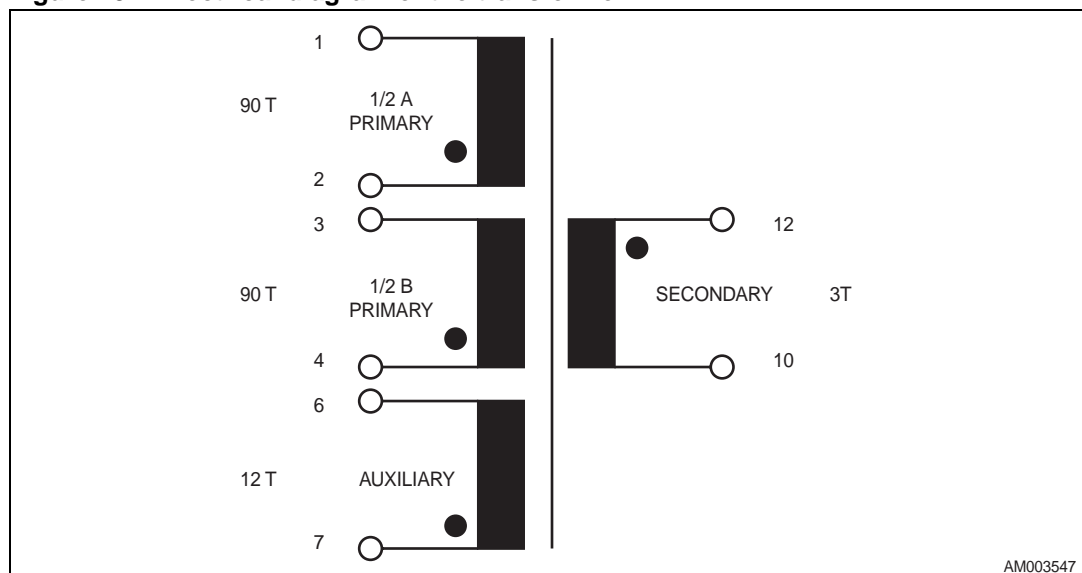

For enhanced magnetic coupling, a sandwich topology has been used for the windings. The secondary winding is placed beside the split of the primary winding. The primary winding parts have half the total number of turns and are connected in series. The order of the windings, starting from the winding nearest the core, is: PRIMARY - A, SECONDARY, PRIMARY - B, and then the top AUXILIARY winding for the SMPS' self-supply.

**Table 9. Winding characteristics**

Pins	Winding	Number of turns	Wire type
1-2	PRIMARY - A	90	1 x AVG34
10-12	SECONDARY	3	3 x AVG24
3-4	PRIMARY - B	90	1 x AVG34
6-7	AUXILIARY	12	1 x AVG32

**Figure 30. Winding position**

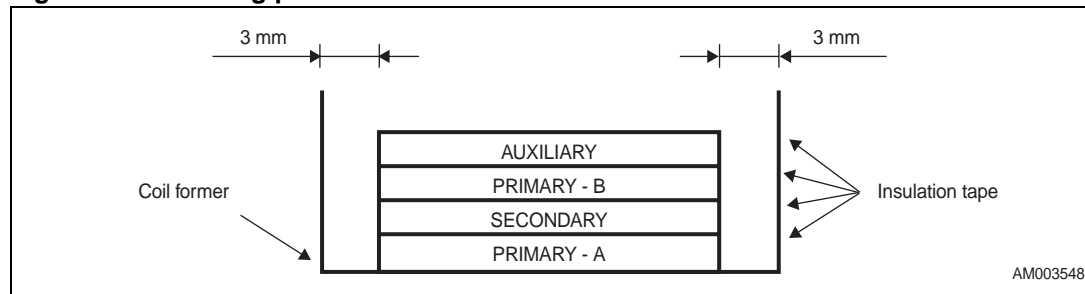

## 9.2 Mechanical aspects

- Maximum height from PCB: 40 mm
- Occupied area on PCB: 35 mm x 25 mm
- Coil former: 14 pins
- Diameter of pins: 1.3 mm + 0.1 mm
- Raster of pins: 5 mm

*Figure 31* shows the mechanical arrangement of the transformer. The figure should be viewed from a mounting angle.

Figure 31. Hole arrangement

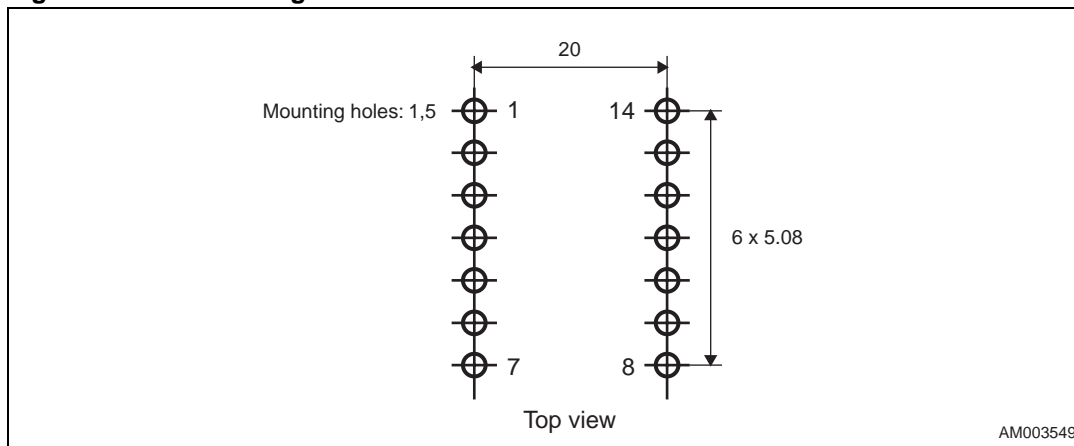



## 10 Ordering information

The application board is orderable online at [http://www.st.com/stonline/domains/buy/buy\\_dev.htm](http://www.st.com/stonline/domains/buy/buy_dev.htm) with the order code *STEVAL-ISA057V1*. The deliverable contains the assembled application board, related documentation, PCB manufacturing data such as gerber and assembly files (pick and place) as well as component documentation.

## 11 Conclusion

This document describes the flyback converter based on the quasi-resonant principle with an ESBT switch driven by a constant current. SMPS is specifically designed for metering applications where wide input voltage ranges are required. The use of an ESBT switch as the main switch has the advantage of simplifying the circuit's design and providing a cost-effective solution.

## 12 References

1. STMicroelectronics L6565 device datasheet.
2. STMicroelectronics STC03DE220HV device datasheet.
3. STMicroelectronics application note AN1326: *L6565 quasi-resonant controller.*
4. STMicroelectronics application note AN1889: *STC03DE170HV in 3-phase auxiliary power supply.*
5. STMicroelectronics application note AN2495: *80 W Very wide input voltage range 3-phase SMPS designed based on L6565 and ESBT STC04IE170HV.*
6. STMicroelectronics application note AN2454: *Universal input voltage power supply for ESBT-based breaker and metering applications.*

## 13 Revision history

**Table 10. Document revision history**

Date	Revision	Changes
13-Mar-2009	1	Initial release.

**Please Read Carefully:**

Information in this document is provided solely in connection with ST products. STMicroelectronics NV and its subsidiaries ("ST") reserve the right to make changes, corrections, modifications or improvements, to this document, and the products and services described herein at any time, without notice.

All ST products are sold pursuant to ST's terms and conditions of sale.

Purchasers are solely responsible for the choice, selection and use of the ST products and services described herein, and ST assumes no liability whatsoever relating to the choice, selection or use of the ST products and services described herein.

No license, express or implied, by estoppel or otherwise, to any intellectual property rights is granted under this document. If any part of this document refers to any third party products or services it shall not be deemed a license grant by ST for the use of such third party products or services, or any intellectual property contained therein or considered as a warranty covering the use in any manner whatsoever of such third party products or services or any intellectual property contained therein.

**UNLESS OTHERWISE SET FORTH IN ST'S TERMS AND CONDITIONS OF SALE ST DISCLAIMS ANY EXPRESS OR IMPLIED WARRANTY WITH RESPECT TO THE USE AND/OR SALE OF ST PRODUCTS INCLUDING WITHOUT LIMITATION IMPLIED WARRANTIES OF MERCHANTABILITY, FITNESS FOR A PARTICULAR PURPOSE (AND THEIR EQUIVALENTS UNDER THE LAWS OF ANY JURISDICTION), OR INFRINGEMENT OF ANY PATENT, COPYRIGHT OR OTHER INTELLECTUAL PROPERTY RIGHT.**

**UNLESS EXPRESSLY APPROVED IN WRITING BY AN AUTHORIZED ST REPRESENTATIVE, ST PRODUCTS ARE NOT RECOMMENDED, AUTHORIZED OR WARRANTED FOR USE IN MILITARY, AIR CRAFT, SPACE, LIFE SAVING, OR LIFE SUSTAINING APPLICATIONS, NOR IN PRODUCTS OR SYSTEMS WHERE FAILURE OR MALFUNCTION MAY RESULT IN PERSONAL INJURY, DEATH, OR SEVERE PROPERTY OR ENVIRONMENTAL DAMAGE. ST PRODUCTS WHICH ARE NOT SPECIFIED AS "AUTOMOTIVE GRADE" MAY ONLY BE USED IN AUTOMOTIVE APPLICATIONS AT USER'S OWN RISK.**

Resale of ST products with provisions different from the statements and/or technical features set forth in this document shall immediately void any warranty granted by ST for the ST product or service described herein and shall not create or extend in any manner whatsoever, any liability of ST.

ST and the ST logo are trademarks or registered trademarks of ST in various countries.

Information in this document supersedes and replaces all information previously supplied.

The ST logo is a registered trademark of STMicroelectronics. All other names are the property of their respective owners.

© 2009 STMicroelectronics - All rights reserved

STMicroelectronics group of companies

Australia - Belgium - Brazil - Canada - China - Czech Republic - Finland - France - Germany - Hong Kong - India - Israel - Italy - Japan - Malaysia - Malta - Morocco - Singapore - Spain - Sweden - Switzerland - United Kingdom - United States of America

[www.st.com](http://www.st.com)

