



### Features

- 75Ω Push-Pull Amplifier
- 40MHz to 1008MHz Operation
- Internally Matched Input and Output
- 17dB Small Signal Gain
- 2.0dB Noise Figure
- Single 7V Positive Power Supply

### Applications

- Linear LNA/Driver
- CATV Line Driver Amplifier
- Broadband Gain Blocks
- FTTx / xPON / ONU Driver Amplifier

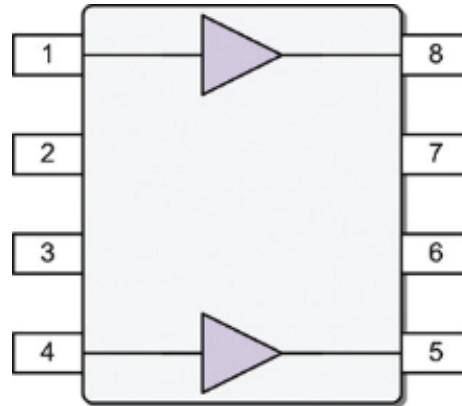

Functional Block Diagram

### Product Description

RFMD's RFCA8818 is a low-noise, linear high performance GaAs MESFET MMIC amplifier. The RFCA8818 contains two amplifiers for use in wideband push-pull CATV amplifiers requiring excellent second order performance. The second and third order non-linearities are greatly improved in the push-pull configuration.

### Ordering Information

RFCA8818SQ	Sample bag with 25 pieces
RFCA8818SR	7" Reel with 100 pieces
RFCA8818TR13	13" Reel with 2500 pieces
RFCA8818PCK-410	40MHz to 1008MHz PCBA with 5-piece sample bag

## Absolute Maximum Ratings

Parameter	Rating	Unit
Device Voltage	9	V
RF Input Power	13	dBm
Operating Temperature Range	-40 to +85	°C
Storage Temperature Range	-40 to +150	°C



**Caution!** ESD sensitive device.

Exceeding any one or a combination of the Absolute Maximum Rating conditions may cause permanent damage to the device. Extended application of Absolute Maximum Rating conditions to the device may reduce device reliability. Specified typical performance or functional operation of the device under Absolute Maximum Rating conditions is not implied.

The information in this publication is believed to be accurate and reliable. However, no responsibility is assumed by RF Micro Devices, Inc. ("RFMD") for its use, nor for any infringement of patents, or other rights of third parties, resulting from its use. No license is granted by implication or otherwise under any patent or patent rights of RFMD. RFMD reserves the right to change component circuitry, recommended application circuitry and specifications at any time without prior notice.



RFMD Green: RoHS compliant per EU Directive 2002/95/EC, halogen free per IEC 61249-2-21, < 1000ppm each of antimony trioxide in polymeric materials and red phosphorus as a flame retardant, and <2% antimony in solder.

## Nominal Operating Parameters

Parameter	Specification			Unit	Condition
	Min.	Typ.	Max.		
<b>Overall 75Ω</b>					Temp = -40 °C to +85 °C, V <sub>CC</sub> = 7V, Standard Application Circuit
Frequency Range	40		1008	MHz	
Gain	16	17	18	dB	
Gain Flatness		±1.0		dB	40MHz to 1008MHz
Noise Figure		2.0	2.5	dB	40MHz to 1008MHz
Input Return Loss	8	10		dB	40MHz to 1008MHz
Output Return Loss	13	15		dB	40MHz to 1008MHz
Output IP2	53	61	70	dBm	40MHz to 1008MHz, 30MHz tone spacing
Output IP3	35	37		dBm	40MHz to 1008MHz
Output P1dB	24	26			40MHz to 1008MHz
<b>Distortion</b>					
CSO		-72	-62	dBc	77 channels to 550MHz, 34dBmV P <sub>OUT</sub>
CTB		-70	-64	dBc	77 channels to 550MHz, 34dBmV P <sub>OUT</sub>
XMOD		-62	-58	dBc	77 channels to 550MHz, 34dBmV P <sub>OUT</sub>
<b>Thermal</b>					
θ <sub>JC</sub>		30		°C/W	Junction to backside PCB under IC
Maximum Junction Temperature			150	°C	
<b>Power Supply</b>					
Supply Voltage (V <sub>DD</sub> )		7		V	
Operating Current Range		220		mA	

**Typical Performance**

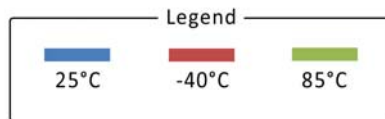
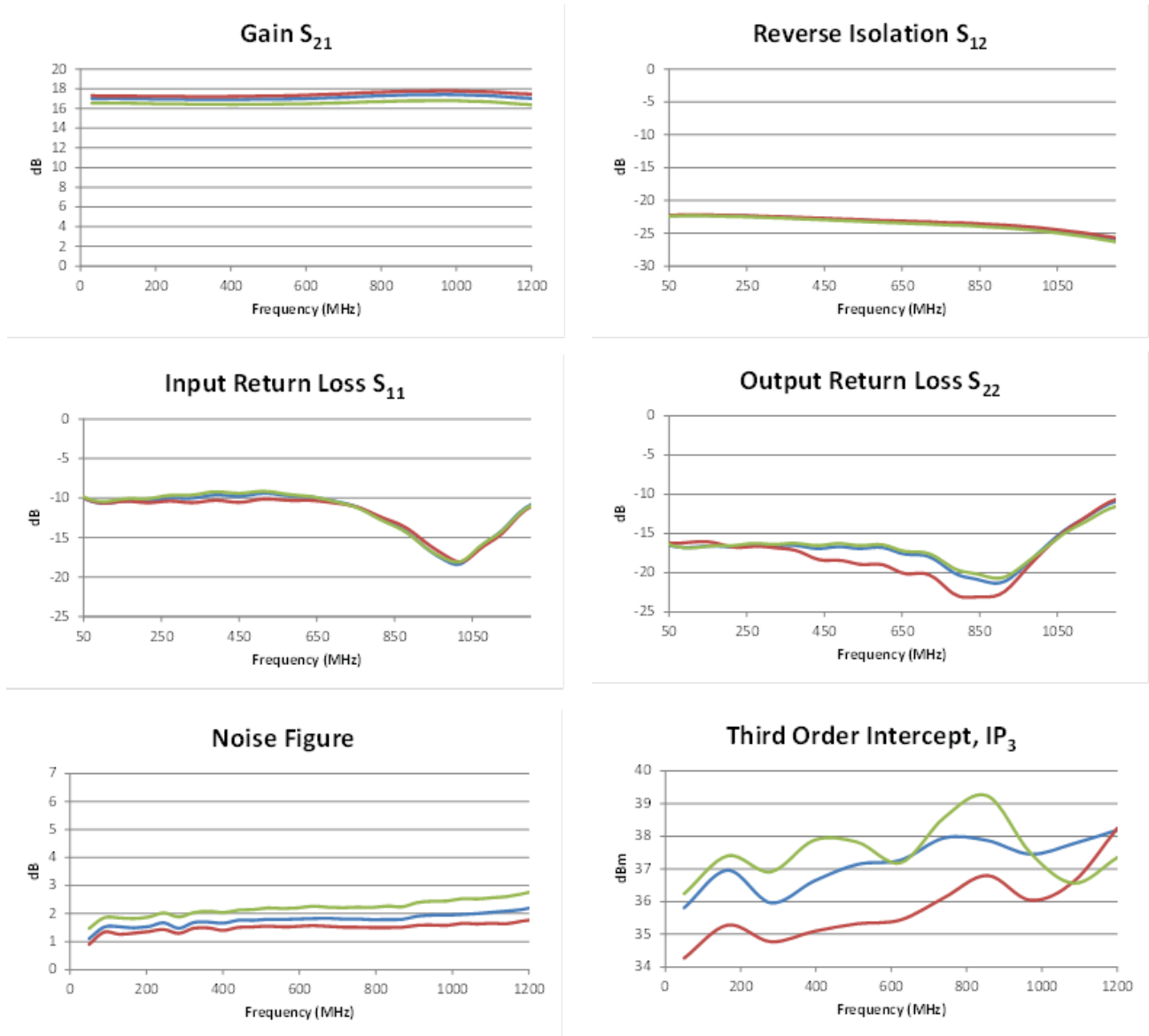

## Typical Performance (continued)

### Second Order Intercept, $IP_2$

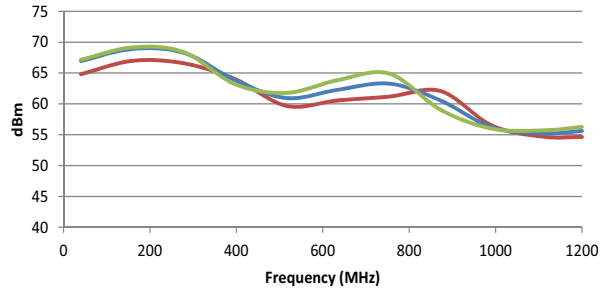

### P1dB

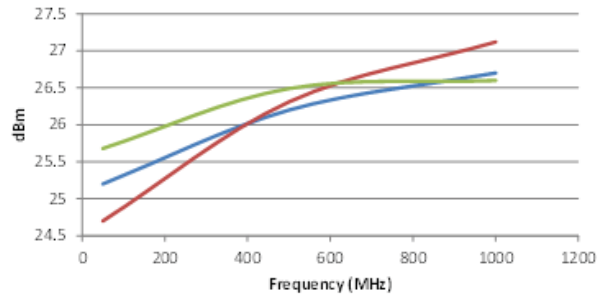

### CSO

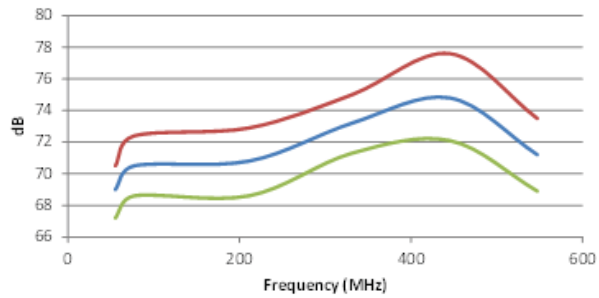

### CTB

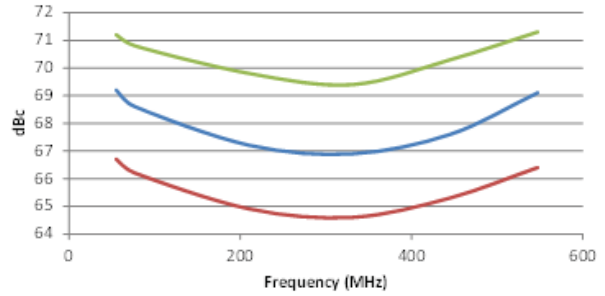

#### Legend

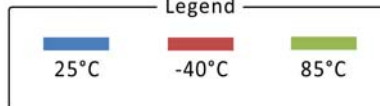

**Pin Names and Descriptions**

Pin	Name	Description
1	RFIN	Device 1, RF input pin. This pin is internally DC blocked. An external DC blocking capacitor is not required.
2, 3, 6, 7	GND	Connection to ground. use via holes for best performance to reduce lead inductance as close to ground leads as possible.
4	RFIN	Device 1, RF input pin. This pin is internally DC blocked. An external DC blocking capacitor is not required.
5	RFOUT / VCC	Device 2, RF output and bias pin. Because DC is present on this pin, a DC blocking capacitor suitable for the frequency of operation should be used in most applications. For biasing, only an RF choke is needed.
8	RFOUT / VCC	Device 1, RF output and bias pin. Because DC is present on this pin, a DC blocking capacitor suitable for the frequency of operation should be used in most applications. For biasing, only an RF choke is needed.
EPAD	GND	Exposed area on the bottom side of the package must be soldered to the ground plane of the board for optimum thermal and RF performance. Several vias should be located under the EPAD as shown in the recommended land pattern.

**PCB Pad Layout**

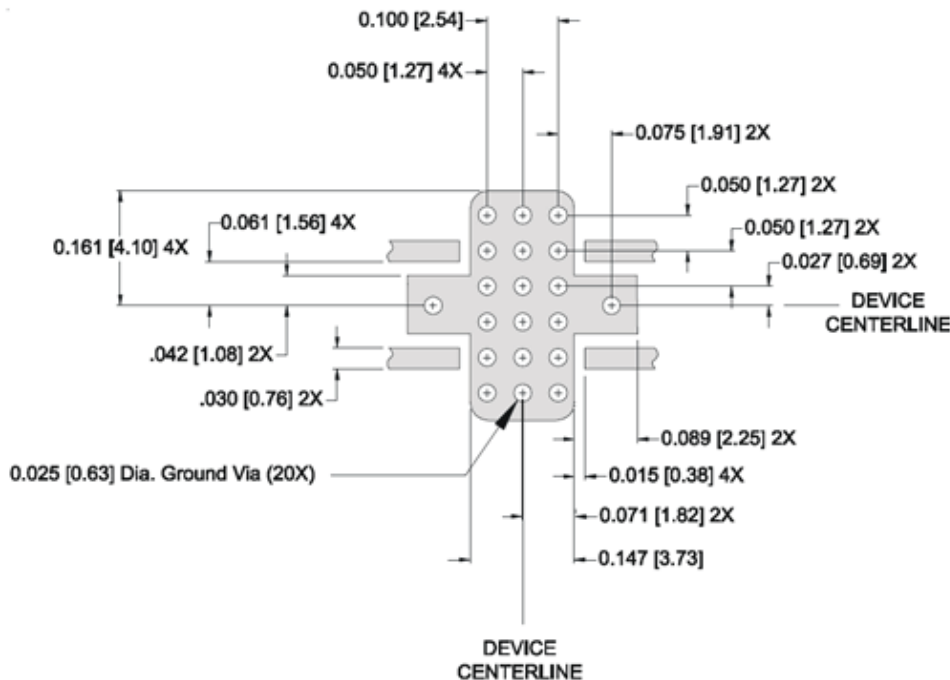

## Package Drawing

Package Type: Thermally Enhanced SOIC-8  
Dimensions in inches

- NOTES:
- 1. SHADED LEAD IS PIN 1.
  - 2. LEAD COPLANARITY: .003 WITH RESPECT TO DATUM 'A'.
  - 3. DIMENSIONS DO NOT INCLUDE MOLD FLASH OR PROTRUSIONS.

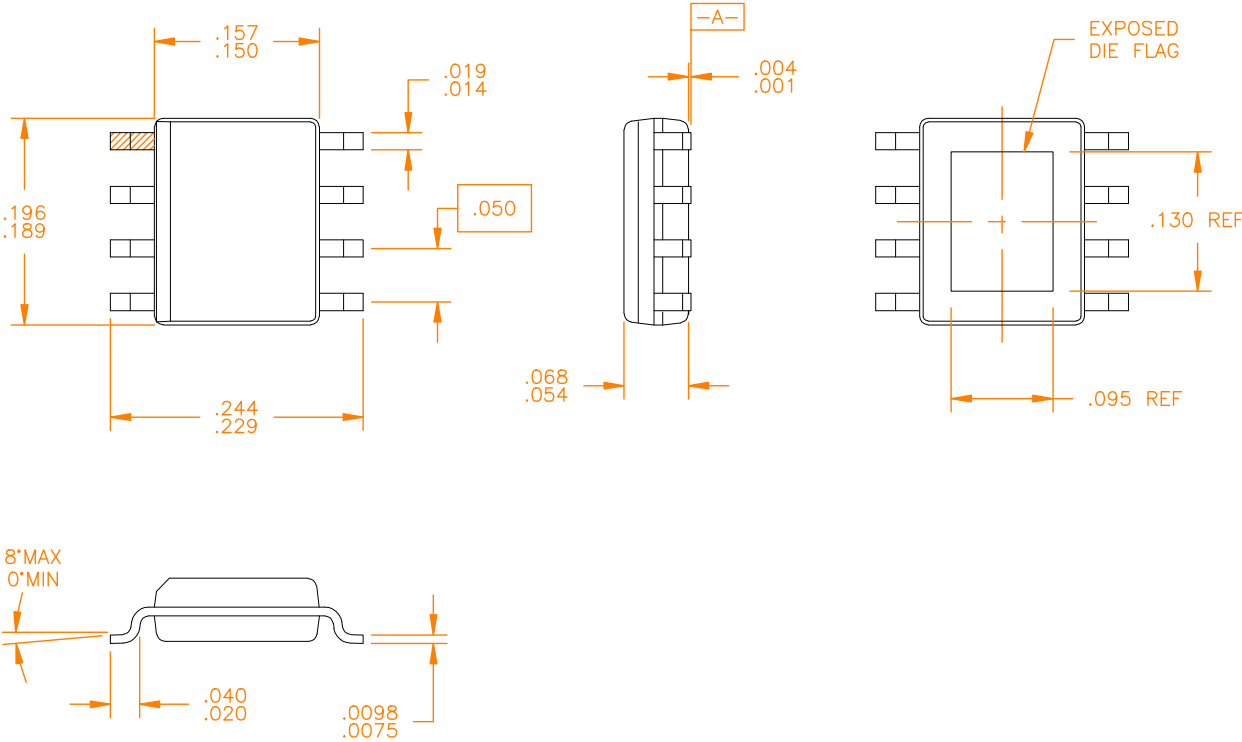

**Evaluation Board Schematic**

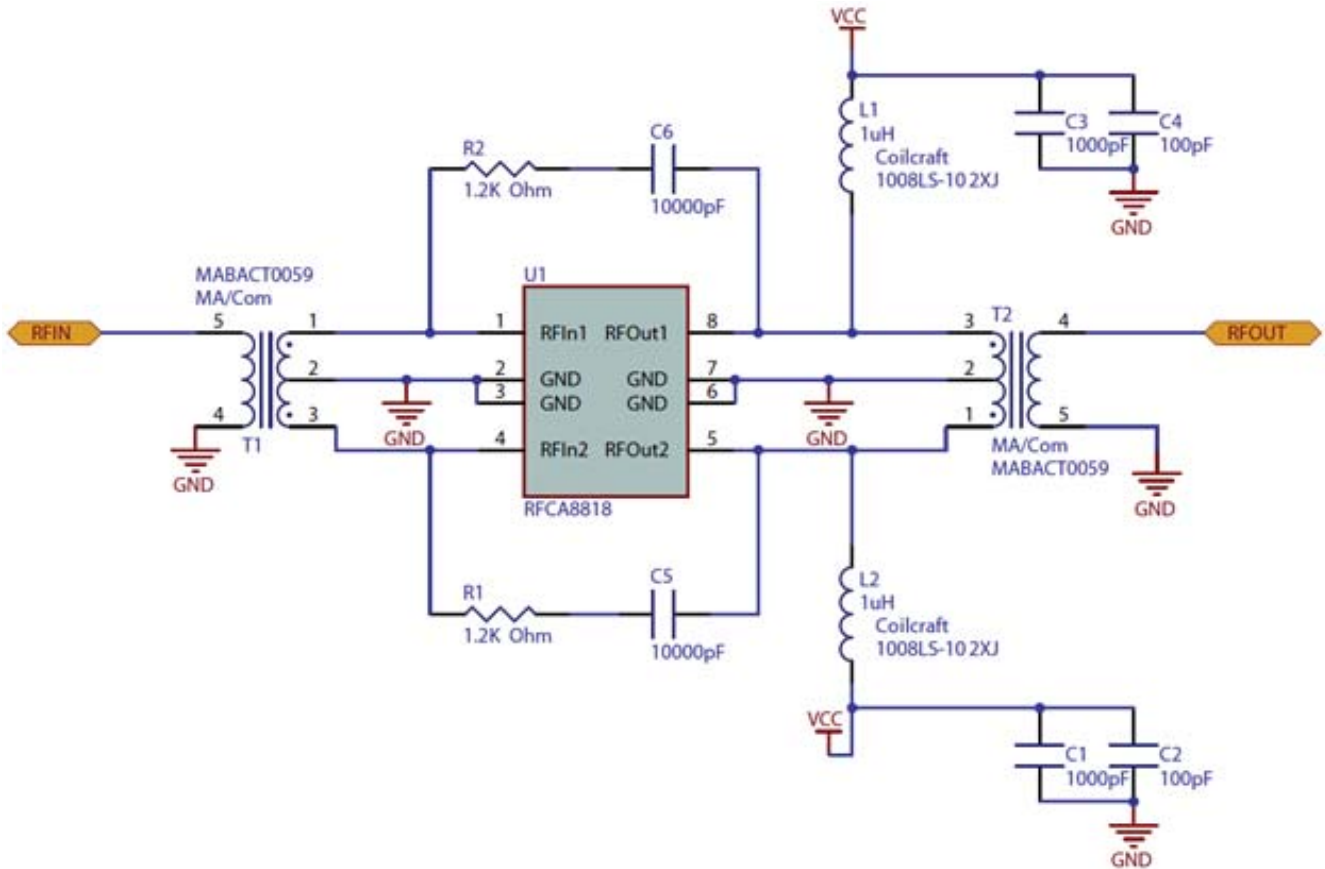

**Evaluation Board Bill of Materials (BOM)**

Description	Reference Designator	Manufacturer	Manufacturer's P/N
Evaluation Board			RFC A8818410(C)
DUAL CATV 50MHz to 1000MHz HI LIN GaAs MESFET	U1	RFMD	RFC A8818
RES, 0Ω, 0603	R1, C9-C10	PANASONIC INDUSTRIAL CO	ERJ-3GEYOR00V
RES, 1.2K, 5%, 1/10W, 0603	R2-R3	PANASONIC INDUSTRIAL CO	ERJ-3GEYJ122V
CAP, 1μF, 10%, 10V, X5R, 0603	C3, C6	Murata Electronics	GRM188R61A105KA61D
CAP, 1000pF, 10%, 50V, X7R, 0603	C1-C2, C4-C5, C7-C8	Murata Electronics	GRM188R71H103KA01D
IND, 1μH, 5%, W/W, 0805	L1-L2	Coilcraft, Inc.	0805LS-102XJLC
BALUN, 1:1, 4.5MHz to 3000MHz, 75Ω, SMD	T1-T2	M/A-COM Technology Solutions, Inc.	MABACT0059
CONN, HDR, ST, PLRZD, 4-PIN, 0.100"	P1	AMP	640454-4
CONN, F, EDGE MOUNT, 62 MIL	J1-J2	Trompeter	CBJE130-1
CONN, F FEM EDGE MOUNT, 75Ω, 0.068"	J1-J2	Millimeter Wave Technologies, LLC	MW-846-C-DD-75

## Branding Diagram

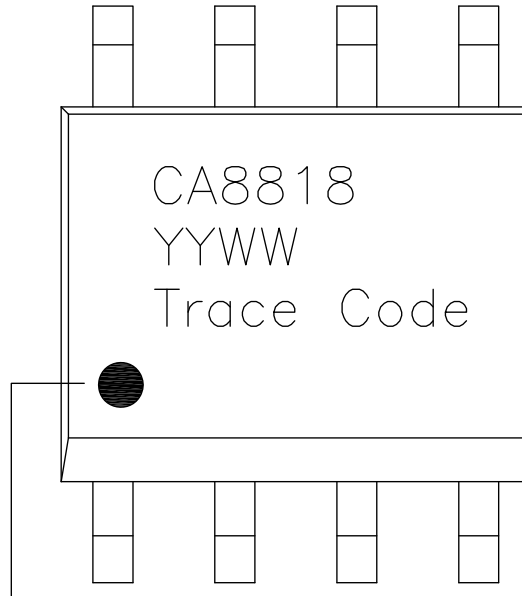

Pin 1 Indicator

Fill in the YYWW Notation  
with the Date Code  
YY = Year  
WW = Week

Trace Code to be assigned  
by Subcon