

General purpose transistor (dual transistors)

EMZ1 / UMZ1N / IMZ1A

●Features

- 1) Both a 2SA1037AK chip and 2SC241ZK chip in a EMT or UMT or SMT package.
- 2) Mounting possible with EMT3 or UMT3 or SMT3 automatic mounting machines.
- 3) Transistor elements are independent, eliminating interference.
- 4) Mounting cost and area can be cut in half.

●Structure

NPN / PNP epitaxial planar silicon transistor

●Equivalent circuit

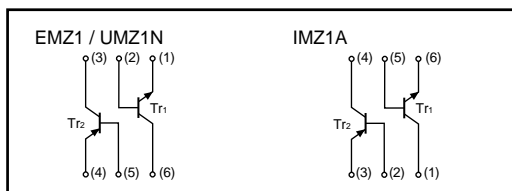

●Absolute maximum ratings (Ta = 25°C)

Parameter	Symbol	Limits		Unit
		Tr1	Tr2	
Collector-base voltage	V_{CB0}	60	-60	V
Collector-emitter voltage	V_{CE0}	50	-50	V
Emitter-base voltage	V_{EB0}	7	-6	V
Collector current	I_c	150	-150	mA
Power dissipation	EMZ1, UMZ1N	150 (TOTAL)		*1 mW
	IMZ1A	300 (TOTAL)		*2 mW
Junction temperature	T_j	150		°C
Storage temperature	T_{stg}	-55~+150		°C

*1 120mW per element must not be exceeded.
*2 200mW per element must not be exceeded.

●External dimensions (Units : mm)

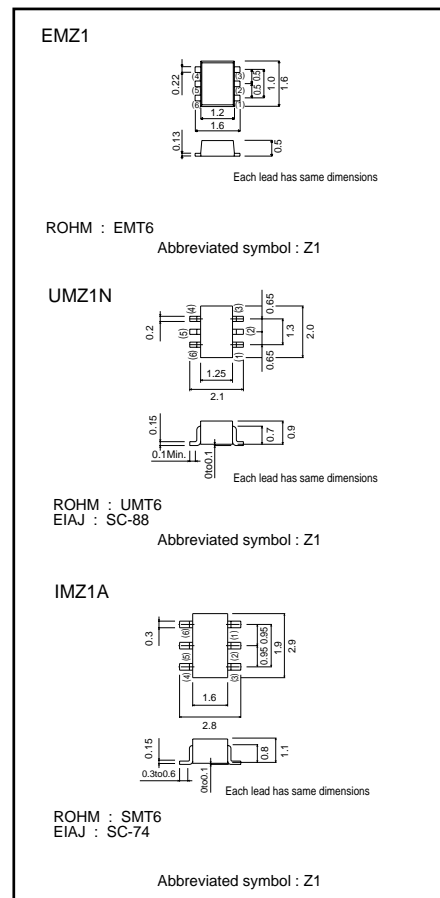

Transistors

●Electrical characteristics (Ta = 25°C)

Tr1 (NPN)

Parameter	Symbol	Min.	Typ.	Max.	Unit	Conditions
Collector-base breakdown voltage	BV _{CB0}	60	—	—	V	I _C =50μA
Collector-emitter breakdown voltage	BV _{CE0}	50	—	—	V	I _C =1mA
Emitter-base breakdown voltage	BV _{EB0}	7	—	—	V	I _E =50μA
Collector cutoff current	I _{CB0}	—	—	0.1	μA	V _{CB} =60V
Emitter cutoff current	I _{EB0}	—	—	0.1	μA	V _{EB} =7V
Collector-emitter saturation voltage	V _{CE(sat)}	—	—	0.4	V	I _C /I _B =50mA/5mA
DC current transfer ratio	h _{FE}	120	—	560	—	V _{CE} =6V, I _C =1mA
Transition frequency	f _T	—	180	—	MHz	V _{CE} =12V, I _E =-2mA, f=100MHz
Output capacitance	C _{ob}	—	2	3.5	PF	V _{CB} =12V, I _E =0A, f=1MHz

Tr2 (PNP)

Parameter	Symbol	Min.	Typ.	Max.	Unit	Conditions
Collector-base breakdown voltage	BV _{CB0}	-60	—	—	V	I _C =-50μA
Collector-emitter breakdown voltage	BV _{CE0}	-50	—	—	V	I _C =-1mA
Emitter-base breakdown voltage	BV _{EB0}	-6	—	—	V	I _E =-50μA
Collector cutoff current	I _{CB0}	—	—	-0.1	μA	V _{CB} =-60V
Emitter cutoff current	I _{EB0}	—	—	-0.1	μA	V _{EB} =-6V
Collector-emitter saturation voltage	V _{CE(sat)}	—	—	-0.5	V	I _C /I _B =-50mA/-5mA
DC current transfer ratio	h _{FE}	120	—	560	—	V _{CE} =-6V, I _C =-1mA
Transition frequency	f _T	—	140	—	MHz	V _{CE} =-12V, I _E =2mA, f=100MHz
Output capacitance	C _{ob}	—	4	5	PF	V _{CB} =-12V, I _E =0A, f=1MHz

●Packaging specifications

Type	Package	Taping		
	Code	T2R	TR	T148
	Basic ordering unit (pieces)	8000	3000	3000
EMZ1	○	—	—	—
UMZ1N	—	○	—	—
IMZ1A	—	—	—	○

●Electrical characteristic curves

Tr1 (NPN)

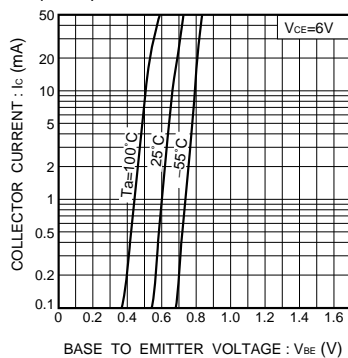

Fig.1 Grounded emitter propagation characteristics

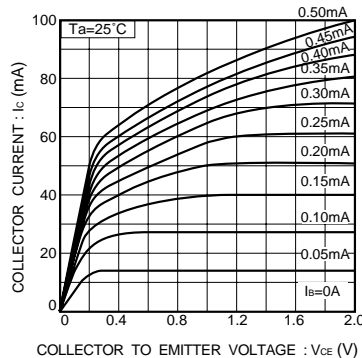

Fig.2 Grounded emitter output characteristics (I)

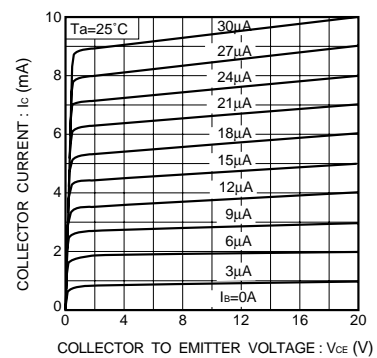

Fig.3 Grounded emitter output characteristics (II)

Transistors

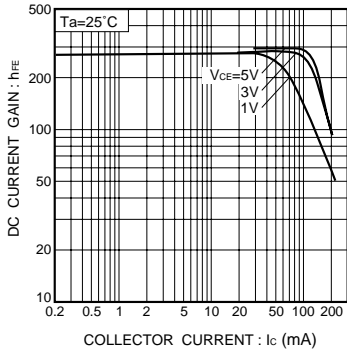

Fig.4 DC current gain vs. collector current (I)

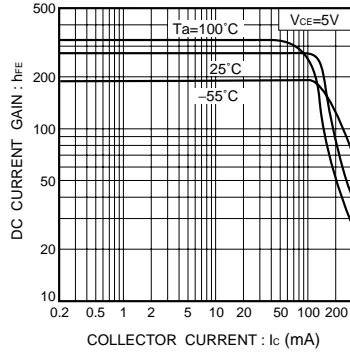

Fig.5 DC current gain vs. collector current (II)

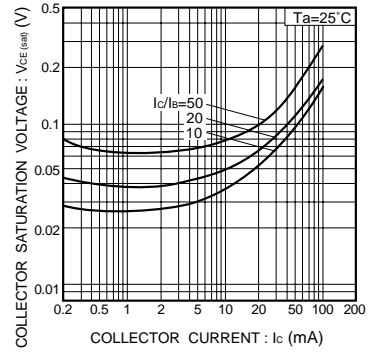

Fig.6 Collector-emitter saturation voltage vs. collector current (I)

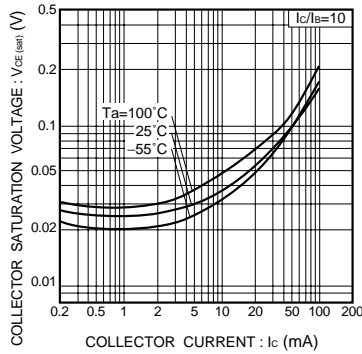

Fig.7 Collector-emitter saturation voltage vs. collector current (II)

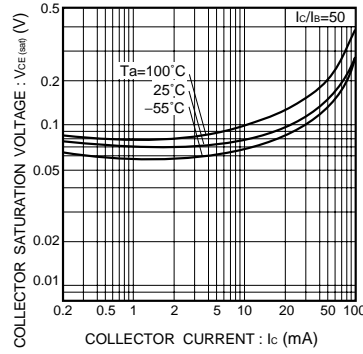

Fig.8 Collector-emitter saturation voltage vs. collector current (III)

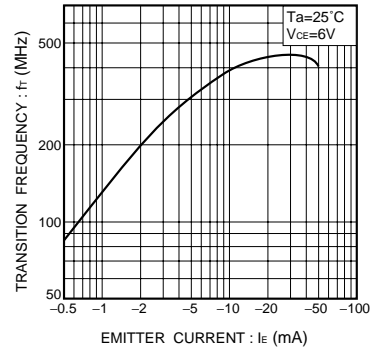

Fig.9 Gain bandwidth product vs. emitter current

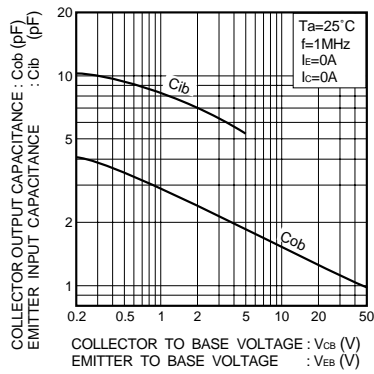

Fig.10 Collector output capacitance vs. collector-base voltage
Emitter input capacitance vs. emitter-base voltage

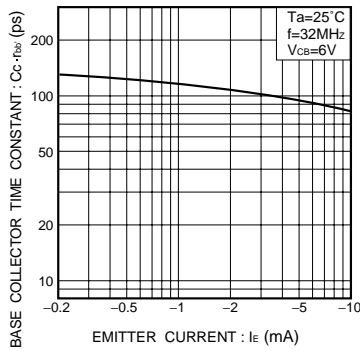

Fig.11 Base-collector time constant vs. emitter current

Transistors

T_{r2} (PNP)

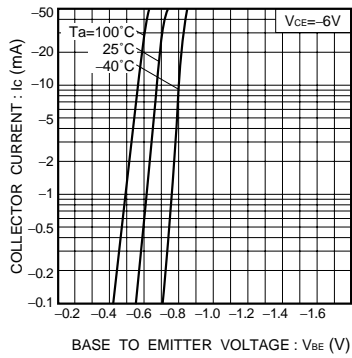

Fig.12 Grounded emitter propagation characteristics

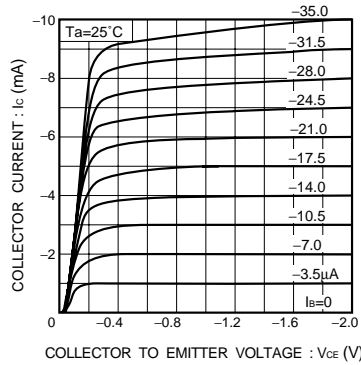

Fig.13 Grounded emitter output characteristics (I)

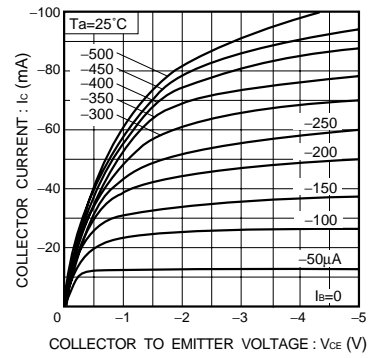

Fig.14 Grounded emitter output characteristics (II)

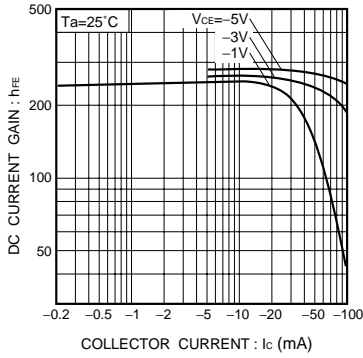

Fig.15 DC current gain vs. collector current (I)

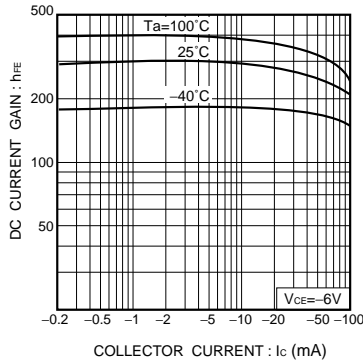

Fig.16 DC current gain vs. collector current (II)

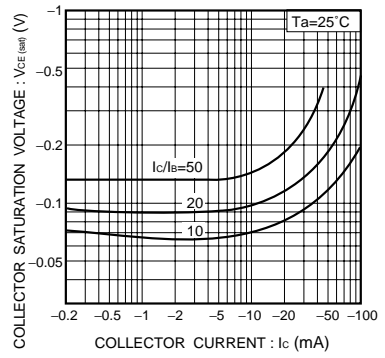

Fig.17 Collector-emitter saturation voltage vs. collector current (I)

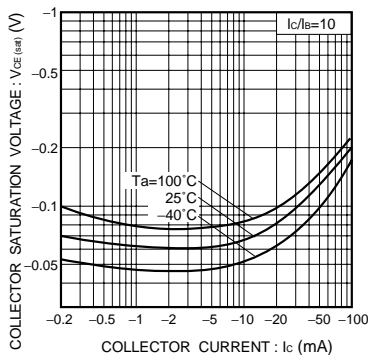

Fig.18 Collector-emitter saturation voltage vs. collector current (II)

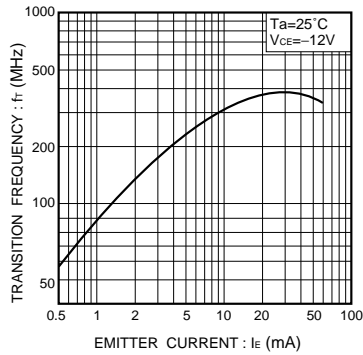

Fig.19 Gain bandwidth product vs. emitter current

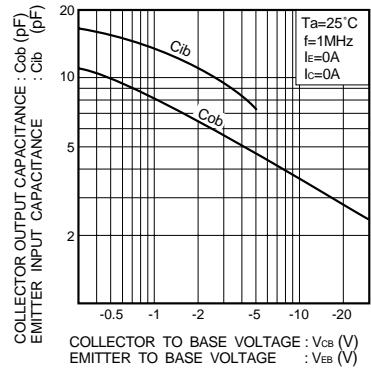

Fig.20 Collector output capacitance vs. collector-base voltage
Emitter input capacitance vs. emitter-base voltage