

CDBHD220-G Thru. CDBHD2100-G

Reverse Voltage: 20 to 100 Volts

Forward Current: 2.0 Amp

RoHS Device



Features

- Schottky barrier chips in TO-269AA bridge.
- Metal semiconductor junction with guard ring.
- Silicon epitaxial planar chips.
- Very low forward drop down voltage.
- For use in low voltage, high efficiency inverters, free wheeling, and polarity protection applications.
- Lead-free parts meet RoHS requirements.
- UL recognized file # E321971

Mechanical data

- Case: TO-269AA, molded plastic.
- Terminals: solderable per MIL-STD-750, method 2026.
- Polarity: Marked on body.
- Mounting Position: Any.
- Weight:0.22 gram(approx.).

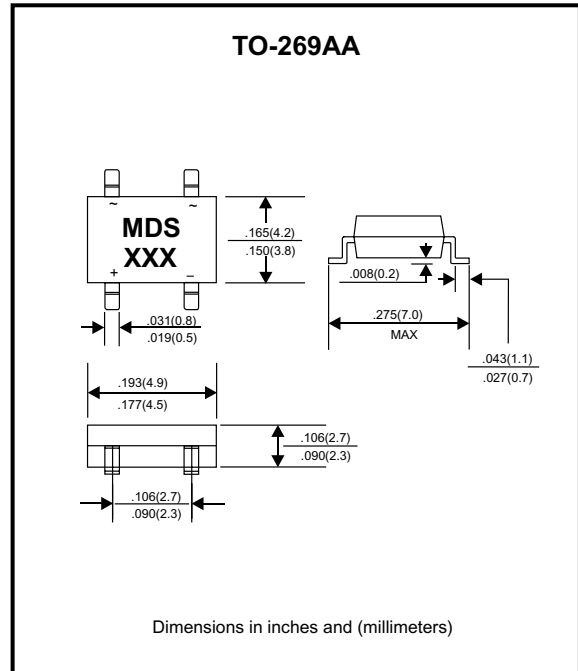

Maximum Ratings and Electrical Characteristics

Parameter	Conditions	Symbol	CDBHD 220-G	CDBHD 240-G	CDBHD 260-G	CDBHD 280-G	CDBHD 2100-G	Units
Max. repetitive peak reverse voltage		V_{RRM}	20	40	60	80	100	V
Max. DC blocking voltage		V_{RMS}	14	28	42	56	70	V
Max. RMS voltage		V_R	20	40	60	80	100	V
Max. Instantaneous forward voltage at 2.0A		V_F	0.5		0.70	0.85		V
Average Forward rectified current	2.0X2.0"(5.0x5.0mm) copper pad, See fig.1	I_{AV}	2.0					A
Peak Forward surge current	8.3ms single half sine-wave superimposed on rate load (JEDEC methode)	I_{FSM}	50					A
Reverse current	$V_R=V_{RRM}$ $T_A=25^{\circ}C$	I_R	0.5					mA
	$V_R=V_{RRM}$ $T_A=100^{\circ}C$		20					
Thermal resistance	Junction to ambient	$R_{\theta JA}$	85					$^{\circ}C/W$
	Junction to lead	$R_{\theta JL}$	20					
Diode junction capacitance	f=1MHz and applied 4V DC reverse voltage	C_J	150					pF
Operating junction temperature		T_J	-55 to +125			-55 to +150		$^{\circ}C$
Storage temperature		T_{STG}	-65 to +175					$^{\circ}C$

RATING AND CHARACTERISTIC CURVES (CDBHD220-G Thru. CDBHD2100-G)

Fig.1 - Forward Current Derating Curve

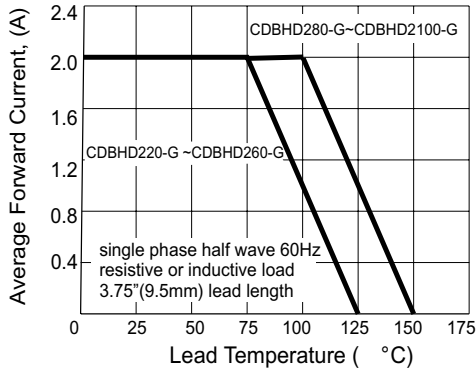

Fig. 2 - Maximum Non-Repetitive Peak Forward Surge Current

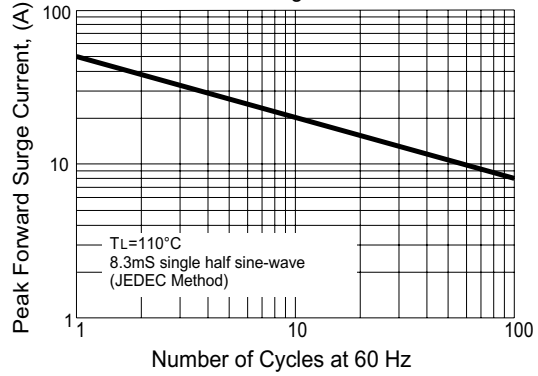

Fig. 3 - Typical Instantaneous Forward Characteristics

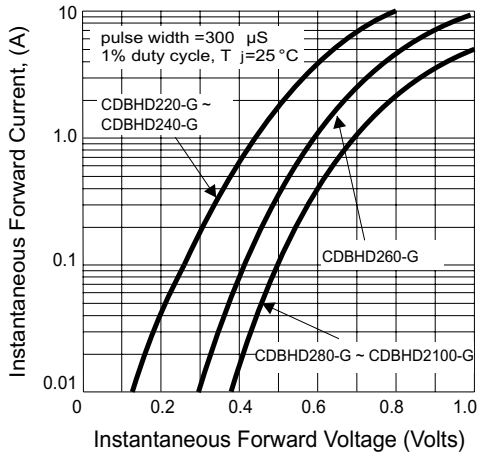

Fig. 4A - Typical Reverse Characteristics

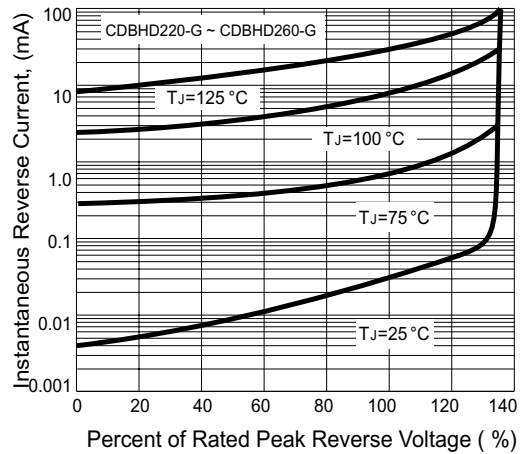

Fig. 5 - Typical Junction Capacitance

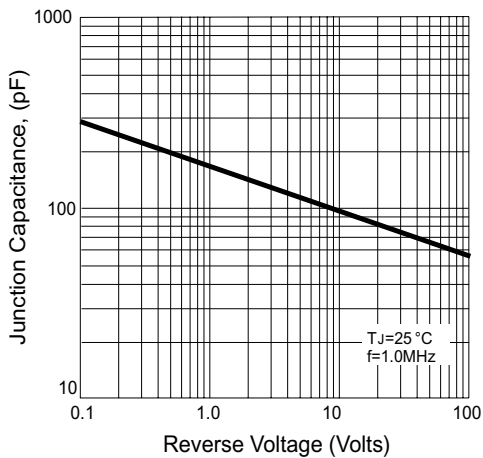
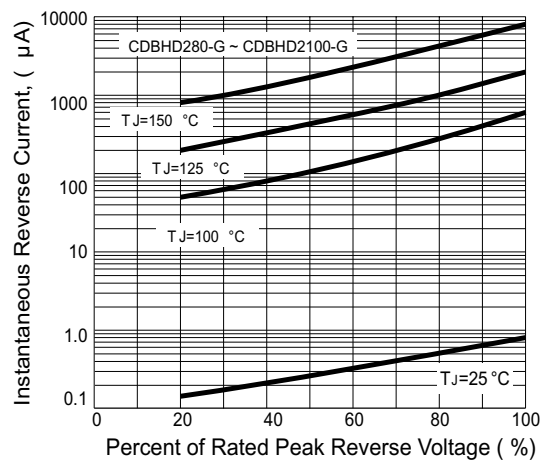
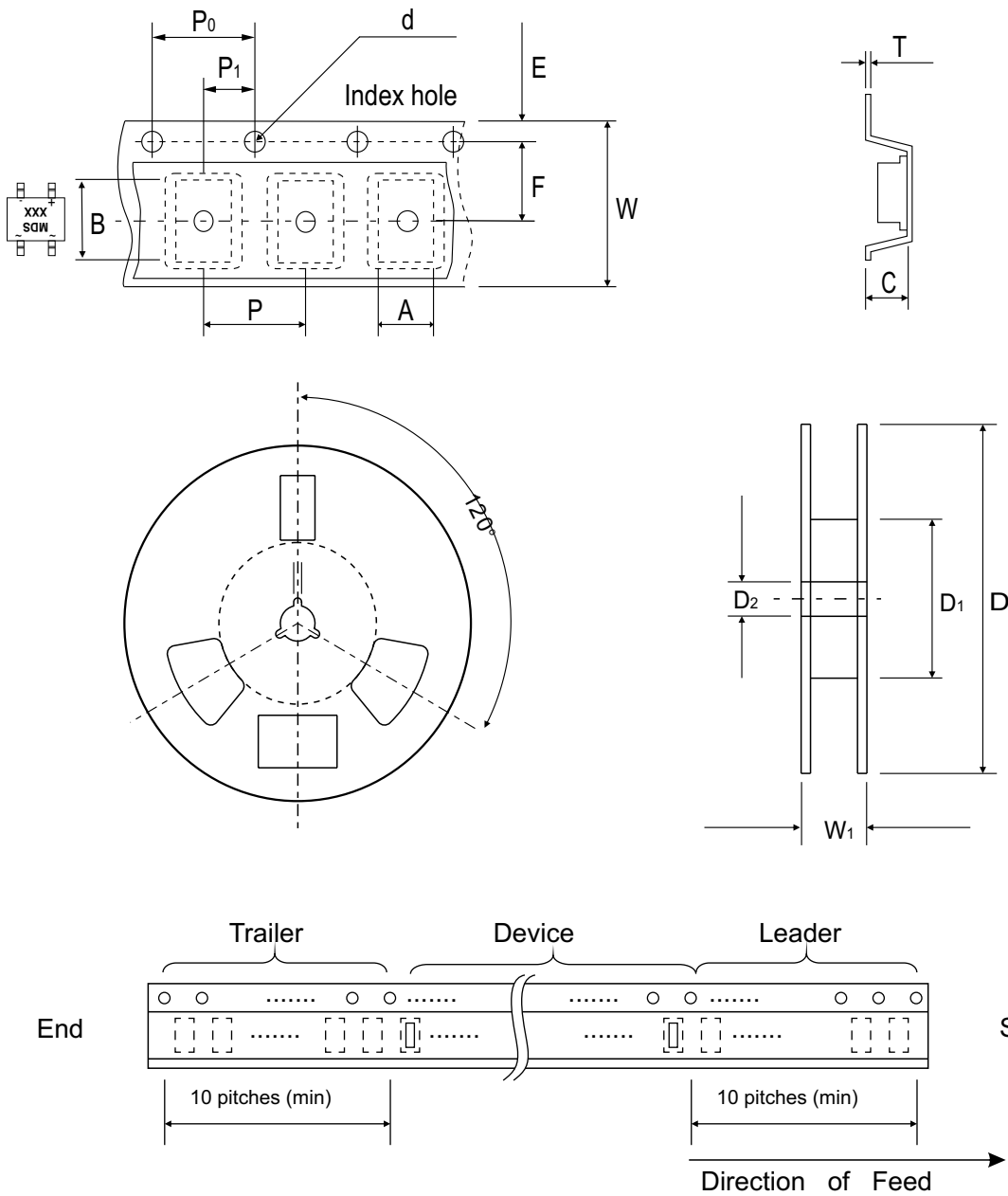

Fig. 4B - Typical Reverse Characteristics



Reel Taping Specification



TO-269AA	SYMBOL	A	B	C	d	D	D ₁	D ₂
	(mm)	5.00 ± 0.10	3.20 ± 0.10	2.90 ± 0.10	1.55 ± 0.10	330 ± 1.00	50.0 MIN.	13.0 ± 0.20
	(inch)	0.197 ± 0.004	0.126 ± 0.004	0.114 ± 0.004	0.0610 ± 0.004	12.992 ± 0.039	1.969 MIN.	0.512 ± 0.008

TO-269AA	SYMBOL	E	F	P	P ₀	P ₁	W	W ₁
	(mm)	1.75 ± 0.10	5.50 ± 0.05	8.00 ± 0.10	4.00 ± 0.10	2.00 ± 0.05	12.00 ± 0.20	18.40 MAX.
	(inch)	0.069 ± 0.004	0.217 ± 0.002	0.315 ± 0.004	0.157 ± 0.004	0.079 ± 0.002	0.472 ± 0.008	0.724 MAX.

Marking Code

Part Number	Marking Code
CDBHD220-G	MDS22
CDBHD240-G	MDS24
CDBHD260-G	MDS26
CDBHD280-G	MDS28
CDBHD2100-G	MDS210

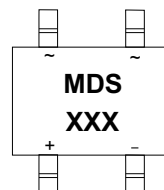

xxx = Product type marking code

Suggested PAD Layout

SIZE	TO-269AA	
	(mm)	(inch)
A	2.67	0.105
B	0.58	0.023
C	0.76	0.030
D	6.91	0.272

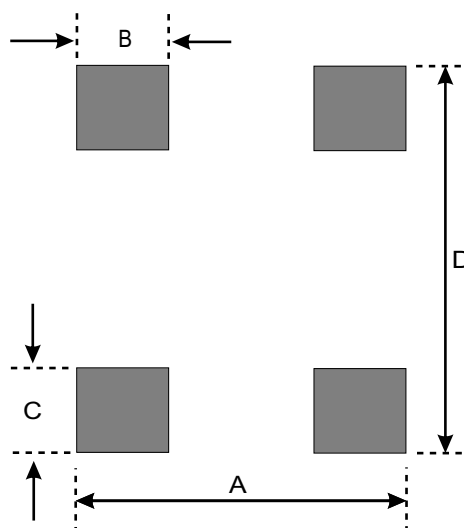

Standard Packaging

Case Type	REEL PACK	
	REEL (pcs)	Reel Size (inch)
TO-269AA	3,000	13