

# 18 - 20 GHz 5-Bit Phase Shifter

# TGP1439

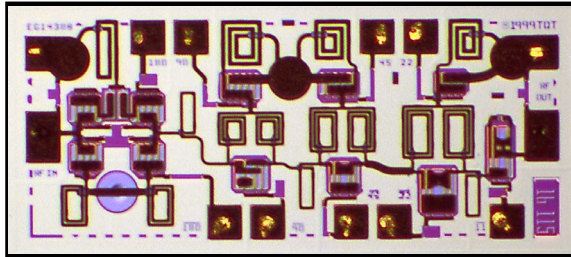

The TriQuint TGP1439 is a 5-Bit Digital Phase Shifter MMIC design using TriQuint's proven 0.5  $\mu\text{m}$  Power pHEMT process to support a variety of K-Band phased array applications including satellite communication systems.

The 5-bit design utilizes a compact topology that achieves a 1.27 mm<sup>2</sup> die area, high performance and good tolerance to control voltage variation

The TGP1439 provides a 5-Bit digital phase shift function with a nominal -5 dB insertion loss and 3° RMS phase shift error over a bandwidth of 18-20 GHz.

The TGP1439 requires a minimum of off-chip components and operates with a -5.0 V to -2.5 V control voltage range. Each device is RF tested on-wafer to ensure performance compliance. The device is available in chip form.

## Key Features and Performance

- 0.5um pHEMT Technology
- 18-20 GHz Frequency Range
- 3° Typical RMS Phase Shift Error
- -5 dB Typical Insertion Loss
- Control Voltage: -2.5 V to -5.0 V
- Compact 1.27 mm<sup>2</sup> Die Area

## Primary Applications

- Phased Arrays
- Satellite Communication Systems

TGP1439 Typical RF Performance (Fixtured)

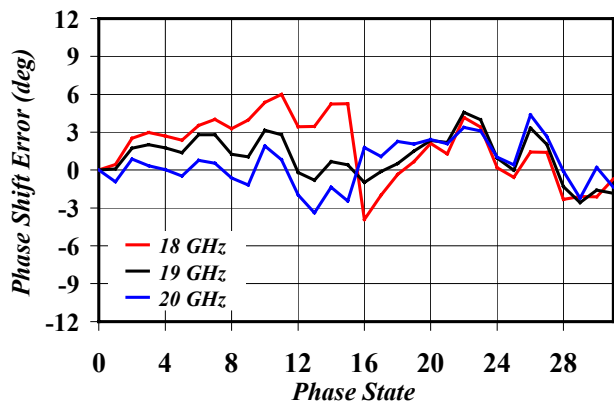

TGP1439 Typical RF Performance (Fixtured)

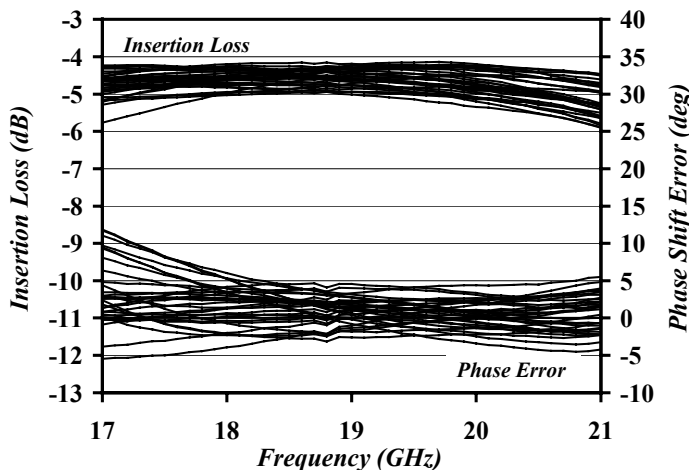

TGP1439 Typical RF Performance (Fixtured)

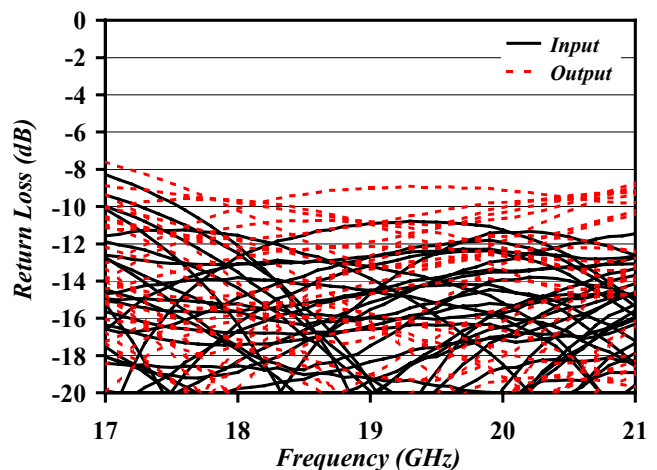

Note: Datasheet is subject to change without notice.

**Electrical Characteristics**  
RECOMMENDED MAXIMUM RATINGS

Symbol	Parameter	Value	Notes
V <sup>-</sup>	Control Voltage	-8 V	
I <sup>+</sup>	Control Current	1 mA	<u>3/</u>
P <sub>D</sub>	Power Dissipation	0.1 W	
P <sub>IN</sub>	Input Continuous Wave Power	20 dBm	
T <sub>CH</sub>	Operating Channel Temperature	150 °C	<u>1/</u> , <u>2/</u>
T <sub>M</sub>	Mounting Temperature (30 seconds)	320 °C	
T <sub>STG</sub>	Storage Temperature	-65 °C to 150 °C	

- 1/ These ratings apply to each individual FET
- 2/ Junction operating temperature will directly affect the device mean time to failure (MTTF). For maximum life it is recommended that junction temperatures be maintained at the lowest possible levels.
- 3/ Total current for the entire MMIC

ON-WAFER RF PROBE CHARACTERISTICS  
(T<sub>A</sub> = 25 °C ± 5°C)

Symbol	Parameter	Test Condition V <sub>ctrl</sub> =0V / -2.5V	Limit			Units
			Min	Nom	Max	
IL	Insertion Loss	F = 18, 19, 20 GHz States 0 and 31	-5.5	-4.6	-4.0	dB
IRL	Input Return Loss	F = 18, 19, 20 GHz States 0 and 31		-16	-11	dB
ORL	Output Return Loss	F = 18, 19, 20 GHz States 0 and 31		-14	-10	dB
PS	Phase Shift	F = 18, 19, 20 GHz State 31	342	344	350	deg

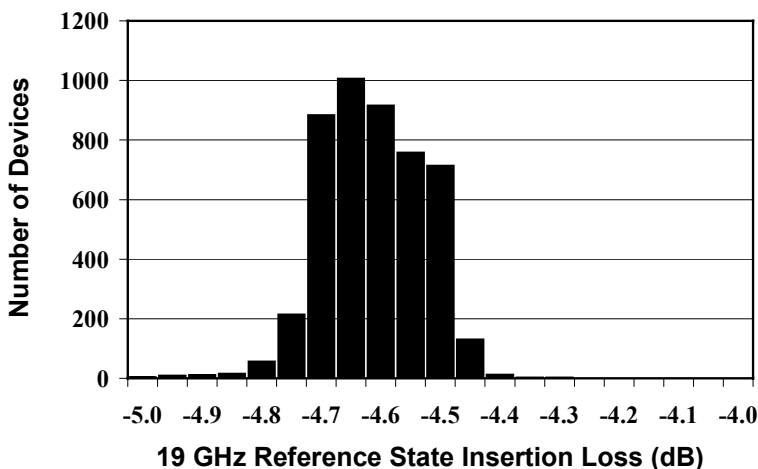

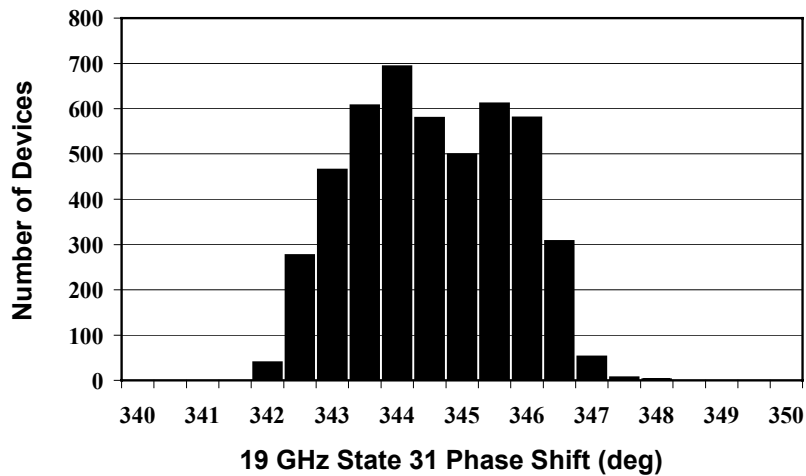
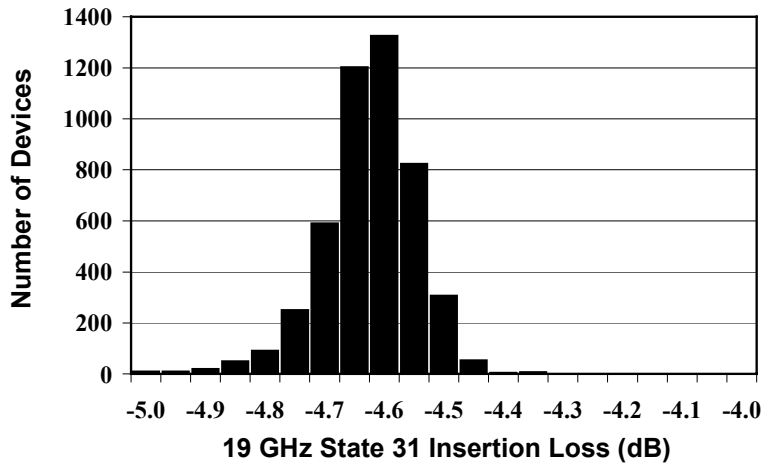

Typical Fixtured Performance Over the 18-20 GHz Band

<i>Parameter</i>	<i>Unit</i>	<i>-5.0 V</i>	<i>-2.5 V</i>
Mean Insertion Loss	dB	-4.9	-5.0
Mean Loss Flatness	dB	0.3	0.6
Peak Amplitude Error	dBpp	1.2	1.3
RMS Amplitude Error	dB	0.25	0.30
Peak Phase Shift Error	deg	-3 / +7	-3 / +7
RMS Phase Shift Error	deg	3.0	2.7
Loss Temp. Variation	dB/°C	-0.0048	-0.0052
Ave Input Return Loss	dB	-16	-15
Ave Output Return Loss	dB	-15	-15

Mechanical Characteristics

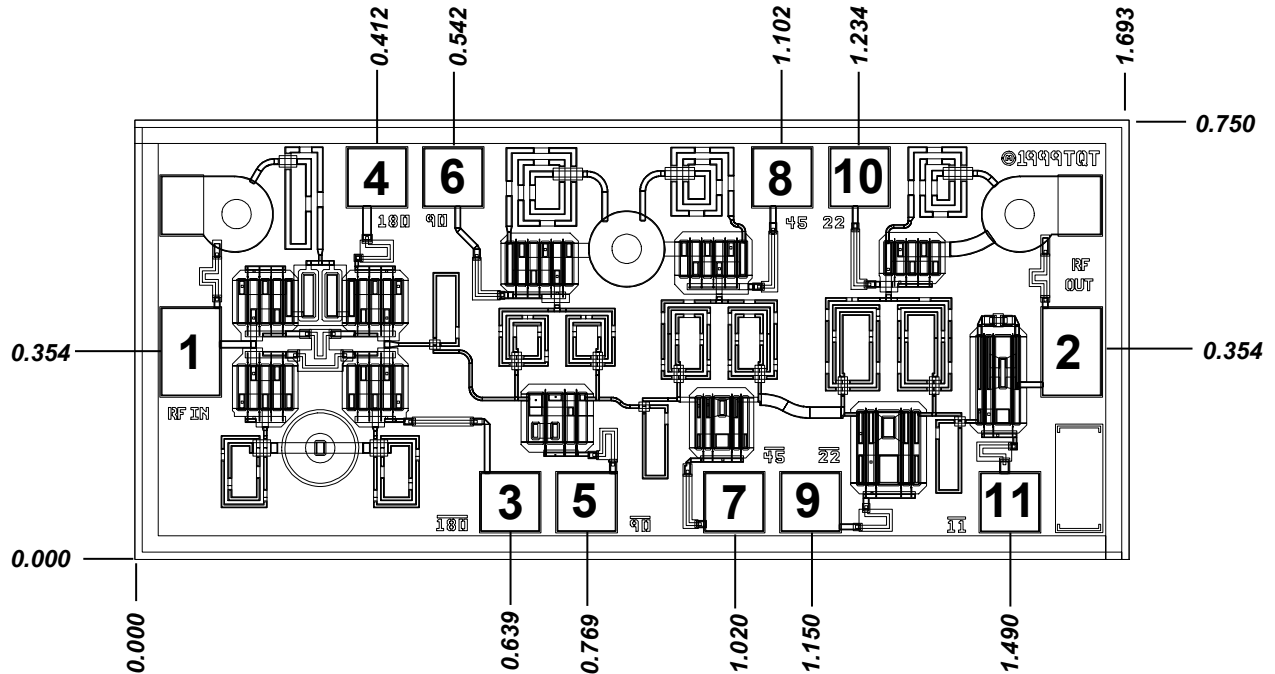

Units: millimeters

Thickness: 0.1016

Chip size tolerance: +/- 0.0508

Vcctl = -5.0 V to -2.5 V

Passive device, RF IN and RF OUT designators for reference only

Bond Pad #1	(RF IN)	0.100 x 0.150
Bond Pad #2	(RF OUT)	0.100 x 0.150
Bond Pad #3	(180° Bit ON: V= Vcctl)	0.100 x 0.100
Bond Pad #4	(180° Bit ON: V= 0.0V)	0.100 x 0.100
Bond Pad #5	(90° Bit ON: V= Vcctl)	0.100 x 0.100
Bond Pad #6	(90° Bit ON: V= 0.0V)	0.100 x 0.100
Bond Pad #7	(45° Bit ON: V= Vcctl)	0.100 x 0.100
Bond Pad #8	(45° Bit ON: V= 0.0V)	0.100 x 0.100
Bond Pad #9	(22.5° Bit ON: V= Vcctl)	0.100 x 0.100
Bond Pad #10	(22.5° Bit ON: V= 0.0V)	0.100 x 0.100
Bond Pad #11	(11.25° Bit ON: V= Vcctl)	0.100 x 0.100

**Note:** To turn phase bits off, apply the opposite condition. For example to turn Phase bit 180° OFF, Bond Pad 3 = 0.0V and Bond Pad 4 = Vcctl.

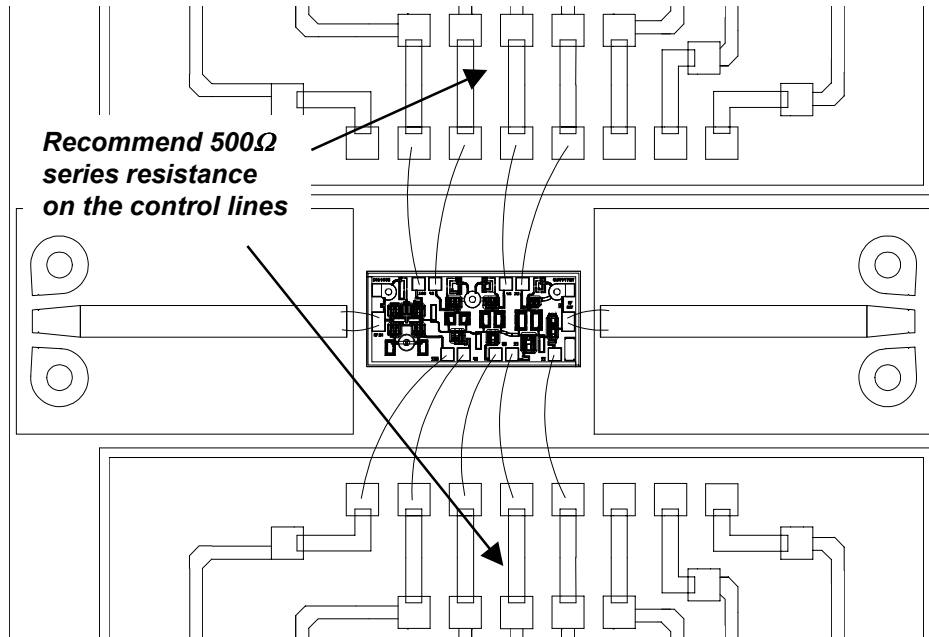

Chip Assembly and Bonding Diagram

Reflow process assembly notes:

- AuSn (80/20) solder with limited exposure to temperatures at or above 300°C
- alloy station or conveyor furnace with reducing atmosphere
- no fluxes should be utilized
- coefficient of thermal expansion matching is critical for long-term reliability
- storage in dry nitrogen atmosphere

Component placement and adhesive attachment assembly notes:

- vacuum pencils and/or vacuum collets preferred method of pick up
- avoidance of air bridges during placement
- force impact critical during auto placement
- organic attachment can be used in low-power applications
- curing should be done in a convection oven; proper exhaust is a safety concern
- microwave or radiant curing should not be used because of differential heating
- coefficient of thermal expansion matching is critical

Interconnect process assembly notes:

- thermosonic ball bonding is the preferred interconnect technique
- force, time, and ultrasonics are critical parameters
- aluminum wire should not be used
- discrete FET devices with small pad sizes should be bonded with 0.0007-inch wire
- maximum stage temperature: 200°C

**GaAs MMIC devices are susceptible to damage from Electrostatic Discharge. Proper precautions should be observed during handling, assembly and test.**