

AN5365FBP

Video Signal Processor IC for Combined-TV/VCR

Overview

The AN5365FBP is a video signal processor IC to process luminance, chroma, and synchronization signals for combined NTSC TV and VCR set.

Features

- Surface-mount type IC and low power consumption : $P_C=640\text{mW}$ typ.
- Built-in externally-switchable chroma-bandpass-filters (2nd- and 4th- order)
- Adjustable Y-signal delay-time in synchronization with chroma bandpass filter selection
- Incorporating an APL-controlled white peak limiter circuit and a black level correction circuit
- Designed for use with a VCR IC of AN3456 for the rationalization of combined TV/VCR set (quartz oscillators and 1H delay lines can be shared)

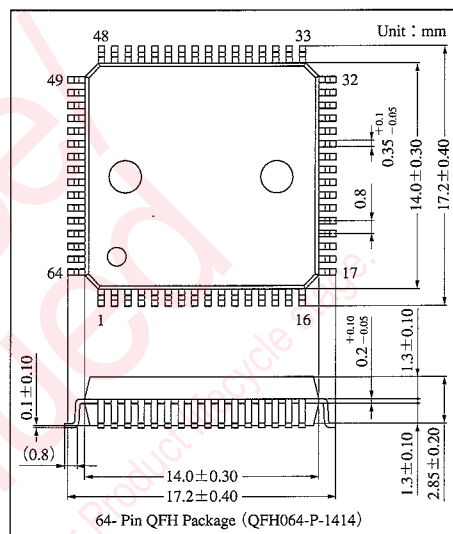

Absolute Maximum Ratings

Parameter	Symbol	Rating		Unit
Supply voltage	V_{CC}	$V_{CC1,2}$ (2, 12)	5.5	V
		V_{CC3} (48)	9.9	
Supply current	I_{CC}	V_{2+12}	28	mA
		I_{15}	22	
		I_{48}	70	
Power dissipation ^{Note 2)}	P_D	851		mW
Operating ambient temperature ^{Note 1)}	T_{opr}	-20 to +70		°C
Storage temperature ^{Note 1)}	T_{stg}	-55 to +150		°C

Note 1) $T_a=25^\circ\text{C}$ except operating temperature ambient and storage temperature.

Note 2) Allowable power dissipation of the package at $T_a=70^\circ\text{C}$.

Recommended Operating Range ($T_a=25^\circ\text{C}$)

Parameter	Symbol	Range
Operating supply voltage range	$V_{CC1,2}$	4.75V to 5.25V
	V_{CC3}	8.55V to 9.45V
Operating supply current range	I_{15}	9.0mA to 20mA

■ Block Diagram

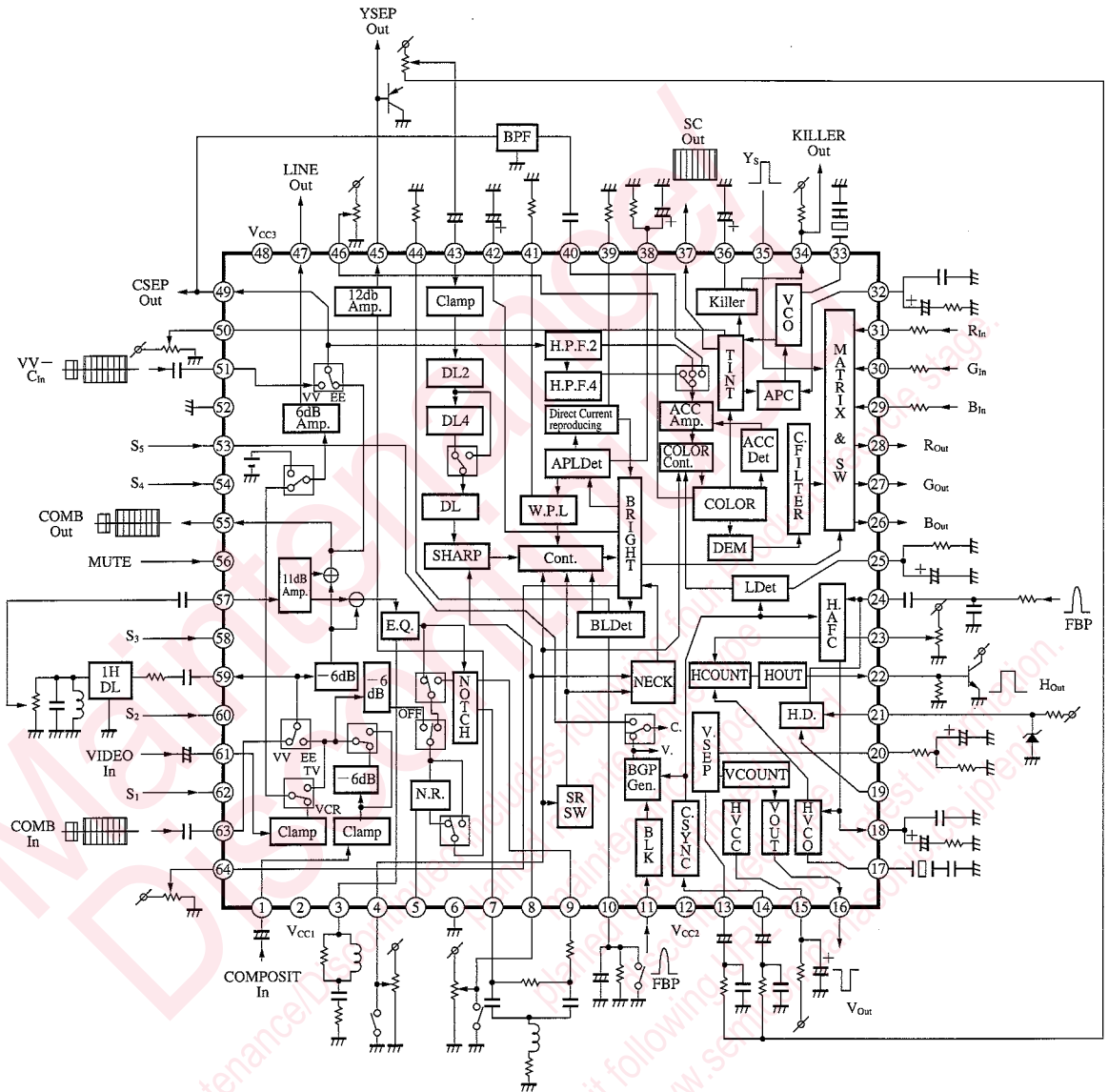

ICs for TV

■ Electrical Characteristics (Ta=25±2°C)

Parameter	Symbol	Condition	min	typ	max	Unit
DC Characteristics						
Circuit current 1	I ₂	V _{CC1,2} =5V, V _{CC3} =9V I ₁₅ =10mA	8.3	9.8	11.3	mA
Circuit current 2	I ₁₂	V _{CC1,2} =5V, V _{CC3} =9V I ₁₅ =10mA	9.4	11.1	12.8	mA
Circuit current 3	I ₄₈	V _{CC1,2} =5V, V _{CC3} =9V I ₁₅ =10mA	45.3	53.4	61.5	mA
Circuit voltage	V ₁₅	V _{CC1,2} =5V, V _{CC3} =9V I ₁₅ =10mA	5.8	6.2	6.9	V
Current voltage operation resistor	γ ₁₅	V _{CC1,2} =5V, V _{CC3} =9V I ₁₅ =9 to 20mA	—	3	30	Ω
Impedance Pin③	Z ₃	V _{CC1,2} =5V, V _{CC3} =9V I ₁₅ =10mA I ₃ =-1.0 to +1.0mA	200	400	600	Ω
Impedance Pin⑨	Z ₉	V _{CC1,2} =5V, V _{CC3} =9V I ₁₅ =10mA I ₉ =-2.5 to +2.5mA	40	90	200	Ω
Impedance Pin⑯	Z ₁₆	V _{CC1,2} =5V, V _{CC3} =9V I ₁₅ =10mA I ₁₆ =-0.1 to +0.1mA	250	500	1300	Ω
Impedance Pin⑳	Z ₂₆	V _{CC1,2} =5V, V _{CC3} =9V I ₁₅ =10mA I ₂₆ =-1.0 to +1.0mA	40	80	200	Ω
Impedance Pin㉑	Z ₂₇	V _{CC1,2} =5V, V _{CC3} =9V I ₁₅ =10mA I ₂₇ =-1.0 to +1.0mA	40	80	200	Ω
Impedance Pin㉒	Z ₂₈	V _{CC1,2} =5V, V _{CC3} =9V I ₁₅ =10mA I ₂₈ =-1.0 to +1.0mA	40	80	200	Ω
Impedance Pin㉓	Z ₄₅	V _{CC1,2} =5V, V _{CC3} =9V I ₁₅ =10mA I ₄₅ =-1.0 to +1.0mA	30	60	200	Ω
Impedance Pin㉔	Z ₄₇	V _{CC1,2} =5V, V _{CC3} =9V I ₁₅ =10mA I ₄₇ =-1.5 to +1.5mA	30	70	200	Ω
Impedance Pin㉕	Z ₄₉	V _{CC1,2} =5V, V _{CC3} =9V I ₁₅ =10mA I ₄₉ =-0.5 to +0.5mA	30	70	200	Ω
Impedance Pin㉖	Z ₅₅	V _{CC1,2} =5V, V _{CC3} =9V I ₁₅ =10mA I ₅₅ =-0.2 to -0.7mA	40	80	200	Ω
Impedance Pin㉗	Z ₅₉	V _{CC1,2} =5V, V _{CC3} =9V I ₁₅ =10mA I ₅₉ =-1.0 to +1.0mA	60	130	300	Ω
Y Signal Processing						
Y standard output	V _{STD}	Cont ; typ., Bright ; typ. Aperture ; min., Vin=0.5V _{P-P}	1.80	2.25	2.70	V _{P-P}
Output at Y input maximum	$\frac{V_{max}}{V_{STD}}$	Cont ; typ., Bright ; typ. Aperture ; min., Vin=0.8V _{P-P}	1.4	1.6	1.7	times
Video voltage gain	A _V	Input ; sine wave 0.2V _{P-P} 2MHz Cont ; max. Aperture ; min., Bright ; typ.	10.4	12.4	14.4	times
Video frequency characteristics (1)	f _{YC}	Attenuation quantity of f=7MHz for output level of f=2MHz Delay line ; DL3 mode	-5.0	-2.5	—	dB
Contrast variable range	$\frac{e_{max}}{e_{min}}$	Input ; sine wave 0.2V _{P-P} 2MHz Cont ; max. to min. Aperture ; min., Bright ; typ.	14.3	17.3	20.3	dB
Picture quality variable range (1)	$\frac{A_{S typ.}}{A_{S min.}}$	f=4.0MHz	6.5	9.6	12.0	dB

Electrical Characteristics (cont.) ($T_a = 25 \pm 2^\circ\text{C}$)

Parameter	Symbol	Condition	min	typ	max	Unit
Y output pedestal level	Y_{PL}	Bright ; 3V	2.6	3.1	3.6	V
Pedestal variable width	ΔBR	$V_{CC1,2} = 5V$, $V_{CC9} = 9V$ Bright ; min. to max.	2.4	2.9	3.4	V
Y output BLK level	Y_{BL}	$V_{CC1,2} = 5V$, $V_{CC3} = 9V$ level in HBLK Bright ; typ.	0.5	1.0	1.5	V
Pin voltage (43)	V_{43-52}	$V_{CC1,2} = 5V$, $V_{CC3} = 9V$ $I_{15} = 10\text{mA}$	3.55	3.85	4.15	V
Brightness control sensitivity	BR	Bright ; 3.5V, 2.5V $\Delta(BR_{3.5V} - BR_{2.5V})/1.0V$	1.08	1.35	1.62	V/V
DC restoration ratio	T_{DC}	Cont ; typ., Aperture ; min. APL 10% to 90% DC restoration ratio correction ; OFF	98	104	108	%
Delay time (1)	τ_{D1}	$V_{CC1,2,3} = \text{typ.}$ Aperture ; min. Delay line ; DL3 mode	420	530	640	ns
Delay time (2)	τ_{D2}	$V_{CC1,2,3} = \text{typ.}$ Aperture ; min. Delay line ; DL1 mode	250	340	430	ns
Black level correction quantity (amplitude variable) (1)	V_{BL} (a) - (b)	Input signal : full black (a) Pin⑩ RC externally mounted (b) Pin⑩ 9V	-100	0	100	mV
Black level correction quantity (amplitude variable) (2)	V_{BL} (c) - (a)	Same as above (c) Pin⑩ 3V	0.37	0.65	0.93	V
Black level correction quantity (amplitude variable) (3)	V_{BL} (a) - (b)	Adjust output amplitude at $0.8V_{P-P}$	0.17	0.30	0.43	V
Black level correction quantity (amplitude variable) (4)	V_{BL} (a) - (b)	Adjust output amplitude at $1.8V_{P-P}$	-120	0	120	mV
DC dispersion of each E_c output	ΔE_{R-G} ΔE_{G-B} ΔE_{B-R}	Bright ; typ., Cont ; typ. Aperture ; min.	—	± 100	± 250	mV
Video voltage gain relative ratio	ΔA_V	Input ; sine wave $0.2V_{P-P}$ 2MHz Cont ; max. Aperture ; min.	-0.8	0	0.8	dB

On-screen Circuit

YS threshold	e_{STH}	Switch level at Pin⑤	1.30	1.65	2.00	V
RGB frequency characteristics	e_{IRGB}	$f = 7\text{MHz}$ amplitude for $f = 2\text{MHz}$ amplitude	-3.0	-1.0	1.0	dB
External input gain	G_{EXT}	$f = 7\text{MHz}$, $0.5V_{P-P}$ $Y_S = 2.5V$	1.6	2.0	2.4	times
Internal·external pedestal difference voltage	ΔY_{PL}	$V_{YS} = 0V - V_{YS} = 2.5V$ RGB input = 0V	90	440	800	mV
External input clip level (1)	$E_{G(1)}$	$V_{YS} = 2.5V$, Bright ; 3V Cont ; 4V	2.10	2.45	2.80	V
External input clip level difference	$\Delta E_{G(1)}$	$V_{YS} = 2.5V$, Bright ; 3V Cont ; 4V	-250	0	+250	mV
External input clip level (2)	$E_{G(2)}$	$V_{YS} = 2.5V$, Bright ; 3V Cont ; 1.5V	1.3	1.6	1.9	V

Color Signal Processing Circuit

Color difference output (B - Y) (1)	e_{01}	Color bar signal (burst 150mV_{P-P}) Cont ; typ., Color ; typ.	1.1	1.4	1.7	V_{P-P}
Color difference output (B - Y) (2)	e_{02}	Color bar signal (burst 150mV_{P-P}) Cont ; typ., Color ; max. Bright ; 4V	3.9	4.8	5.7	V_{P-P}
Color difference signal (color residue) (3)	e_{03}	Color bar signal (burst 150mV_{P-P}) Cont ; typ., Color ; min.	—	15	60	mV_{P-P}

**ICs for
TV**

■ Electrical Characteristics (cont.) ($T_a = 25 \pm 2^\circ\text{C}$)

Parameter	Symbol	Condition	min	typ	max	Unit
ACC characteristics (1)	A_{CC1}	Color bar signal (burst 300mV_{P-P})	0.9	1.0	1.1	times
ACC characteristics (2)	A_{CC2}	Color bar signal (burst 15mV_{P-P})	0.7	0.9	1.1	times
Demodulation output ratio (1)	R/B	Color bar signal (burst 150mV_{P-P}) Cont ; typ., Color ; typ.	1.23	1.40	1.57	times
Demodulation output ratio (2)	G/B	Color bar signal (burst 150mV_{P-P}) Cont ; typ., Color ; typ.	0.37	0.50	0.63	times
Demodulation angle R	$\angle R$	Color bar signal (burst 150mV_{P-P}) Cont ; typ., Color ; typ.	96	104	112	deg
Demodulation angle G	$\angle G$	Color bar signal (burst 150mV_{P-P}) Cont ; typ., Color ; typ.	224	234	244	deg
Demodulation output residual carrier	e_{car}	No signal input 3.58MHz at each output terminal	—	20	50	mV_{P-P}
Color difference output contrast variable range	Δe_{oc}	Color bar signal (burst 150mV_{P-P}) Cont ; min. \rightarrow max. Color ; typ.	14.3	17.3	20.3	dB
Tint center voltage	T_C	Color bar signal (burst 150mV_{P-P}) Cont ; typ., Color ; typ.	2.6	3.0	3.4	V
Tint variable range	$\Delta \theta_t$	Color bar signal (burst 150mV_{P-P}) Cont ; typ., Color ; typ.	± 30	± 42	—	deg
APC pull-in range	f_{PC}	Burst frequency to be variable Adjust f_0 with standard sample	± 500	± 600	—	Hz
VCO free-run frequency	f_{CO}	No signal, FBP pulse OFF Adjust f_0 with standard sample	-150	0	150	Hz
f_{CO} supply voltage dependency	Δf_{CO-V}	Variation quantity for $V_{CC3} = 9\text{V}$ where $V_{CC3} = 9\text{V}$ variable by $+10\%$ to -10%	-120	0	120	Hz
Color killer tolerance	e_K	Color bar signal Cont ; max., Color ; max.	-55	-43	-30	dB
Killer output voltage	V_{34-35}	Chroma no signal $I_{37} = 1\text{mA}$	0	0.2	0.5	V
Sub carrier output level	V_{SC}	$V_{CC3} = 9\text{V}$ no signal	300	450	—	mV_{P-P}
Sub carrier output DC level (1)	$V_{37-52(1)}$	$V_{CC3} = 9\text{V}$ sub-carrier output ; ON	4.7	5.4	6.1	V
Sub carrier output DC level (2)	$V_{37-52(2)}$	$V_{CC3} = 9\text{V}$ sub-carrier output ; OFF	1.20	1.45	1.70	V
Secondary tint center deviation	$\Delta T_{C(2)}$	Tint deviation between when 2nd-order HPF is used and when it isn't used	-4	1	6	deg
6th tint center deviation	$\Delta T_{C(6)}$	Tint deviation between when 6th-order HPF is used and when it isn't used.	2	7	12	deg

Horizontal Signal Processing

Horizontal free-run oscillation frequency (1)	f_{HO-1}	Output frequency at Pin $\text{\textcircled{2}}$	15.45	15.75	16.05	kHz
Horizontal free-run oscillation frequency (2)	f_{HO-2}	In hold down operation Pin $\text{\textcircled{2}}$; 6V, Pin $\text{\textcircled{19}}$; 3.2V	16.3	16.4	16.8	kHz
Horizontal output pulse Duty	τ_{HO}	Hold - Down OFF	46.9	50.0	53.1	%
HOSC start voltage	$V_{fH(S)}$	$f = 10$ to 20kHz when horizontal oscillation output more than 1V_{P-P}	—	—	5.2	V
Terminal voltage (14)	V_{14-6}	V_{CC1} to V_{CC3} ; typ.	1.0	1.3	1.6	V
Horizontal pull-in range	f_{PH}	$f_{HO} = 15.75\text{kHz}$	± 600	—	—	Hz

Electrical Characteristics (cont.) ($T_a=25\pm 2^\circ\text{C}$)

Parameter	Symbol	Condition	min	typ	max	Unit
Overvoltage protective operation start-voltage	V_{X-ray}	$V_{CC}=typ.$ The voltage at which V_{24} voltage begins to decrease at $V_{21}=6V$	2.70	2.95	3.20	V
Lock detection output voltage	V_{LD}	In horizontal AFC lock	5.5	6.0	6.3	V
Horizontal output voltage (H)	V_{22H}		2.4	2.7	3.0	V
Horizontal output voltage (L)	V_{22L}		—	0	0.3	V
Vertical Signal Processing						
Pin voltage (13)	V_{13-6}	V_{CC1} to V_{CC3} ; typ.	1.0	1.3	1.6	V
Vertical free-run oscillation frequency	f_{VO}	$(2f_H/525)$	58	60	62	Hz
Vertical free-run oscillation pulse width	τ_{VO}	$(10/f_H)$	610	640	670	μs
Vertical output voltage (H)	V_{16H}		4.0	4.3	4.6	V
Vertical output voltage (L)	V_{16L}		—	0	0.3	V
YC Separation						
LINE OUT output amplitude	L_V	$V_{in}=2V_{P-P}$, Pin⑥ input VCR mode	3.7	4.0	4.3	V_{P-P}
LINE OUT frequency characteristics	L_f	$V_{in}=0.2V_{P-P}$, $f=10\text{MHz}$ Pin⑥ input VCR mode	-3.0	-0.3	0.5	dB
Y OUT output amplitude (1)	$Y_{V(1)}$	$V_{in}=2V_{P-P}$, Pin① input 6dBATT; ON EE mode	1.75	2.00	2.25	V_{P-P}
Y OUT frequency characteristics (1)	$Y_{f(1)}$	$V_{in}=0.2V_{P-P}$, $f=10\text{MHz}$ Pin① input 6dBATT; ON EE mode	-3.0	-1.0	0.5	dB
Y OUT output amplitude (2)	$Y_{V(2)}$	$V_{in}=1V_{P-P}$, Pin① input 6dBATT; OFF VV mode	1.75	2.00	2.25	V_{P-P}
Y OUT frequency characteristics (2)	$Y_{f(2)}$	$V_{in}=0.2V_{P-P}$, $f=10\text{MHz}$ Pin① input 6dBATT; OFF VV mode	-5.0	-2.5	0.5	dB
C OUT output amplitude (1)	$C_{V(1)}$	$V_{in}=0.6V_{P-P}$, $f=3.58\text{MHz}$ Pin① input 6dBATT; OFF EE mode	0.26	0.30	0.34	V_{P-P}
C OUT output amplitude (2)	$C_{V(2)}$	$V_{in}=0.6V_{P-P}$, $f=3.58\text{MHz}$ Pin⑤ input VV mode	0.55	0.60	0.65	V_{P-P}
COMB OUT output amplitude	CO_V	$V_{in}=0.6V_{P-P}$, $f=3.58\text{MHz}$ Pin③ input VV mode	0.26	0.30	0.34	V_{P-P}
NR characteristics (1)	N.R. (1)	$V_{in}=0.3V_{P-P}$, Pin① input VV mode $N.R. (1) = \frac{f=1\text{MHz}}{f=100\text{kHz}}$	-1.7	-1.2	-0.7	dB
NR characteristics (2)	N.R. (2)	$V_{in}=0.3V_{P-P}$, Pin① input VV mode $N.R. (2) = \frac{f=2\text{MHz}}{f=100\text{kHz}}$	-3.0	-2.0	-1.0	dB
NR characteristics (3)	N.R. (3)	$V_{in}=0.1V_{P-P}$, Pin① input VV mode $N.R. (3) = \frac{f=1\text{MHz}}{f=100\text{kHz}}$	-2.0	-1.2	-0.5	dB
NR characteristics (4)	N.R. (4)	$V_{in}=0.1V_{P-P}$, Pin① input VV mode $N.R. (4) = \frac{f=2\text{MHz}}{f=100\text{kHz}}$	-5.5	-4.1	-2.8	dB
COMB AMP gain	CO_G	$V_{in}=0.1V_{P-P}$, $f=3.58\text{MHz}$ Pin⑦ input EE mode	10.0	11.0	12.0	dB
Y OUT sinc. voltage	SYN_Y	$V_{in}=1V_{P-P}$, 6dBATT; OFF VV mode	0.88	1.00	1.12	V
Y OUT sinc. voltage difference	ΔSYN_Y	$V_{in}=1V_{P-P}$, 6dBATT; OFF EE mode	-130	70	270	mV
LINE OUT sinc. voltage	SYN_L	$V_{in}=2V_{P-P}$, VCR mode	1.5	1.75	2.0	V

**ICs for
TV**

■ Electrical Characteristics (cont.) (Ta = 25 ± 2 °C)

Parameter	Symbol	Condition	min	typ	max	Unit
LINE OUT sinc. voltage difference	ΔSYN_L	$V_{in} = 2V_{P-P}$, TV mode	-0.2	0	0.2	V
MUTE DC voltage difference	MUTE	Difference from LINE OUT sync. voltage	-0.2	0	0.2	V
Switch Circuit						
Mode switch H-M threshold	V_{H-M}	V_{CC1} to V_{CC3} ; typ.	3.2	3.5	3.8	V
Mode switch M-L threshold	V_{M-L}	V_{CC1} to V_{CC3} ; typ.	1.2	1.5	1.8	V
Neck detection threshold	Neth	V_{CC1} to V_{CC3} ; typ.	0.9	1.2	1.5	V
Service switch threshold	Suth	V_{CC1} to V_{CC3} ; typ. Neck detection; ON	0.30	0.65	0.90	V

■ Electrical Characteristics (Design reference value, Ta = 25 ± 2 °C)

Parameter	Symbol	Condition	Reference value	Unit
DC Characteristics				
Impedance Pin ²⁹	Z_{29}	$V_{CC1,2} = 5V$, $V_{CC3} = 9V$ $I_{15} = 10mA$, $I_{29} = 0.1$ to $0.2mA$	30	k Ω
Impedance Pin ³⁰	Z_{30}	$V_{CC1,2} = 5V$, $V_{CC3} = 9V$ $I_{15} = 10mA$, $I_{30} = 0.1$ to $0.2mA$	30	k Ω
Impedance Pin ³¹	Z_{31}	$V_{CC1,2} = 5V$, $V_{CC3} = 9V$ $I_{15} = 10mA$, $I_{31} = 0.1$ to $0.2mA$	30	k Ω
Impedance Pin ³⁵	Z_{35}	$V_{CC1,2} = 5V$, $V_{CC3} = 9V$ $I_{15} = 10mA$, $I_{35} = 0.1$ to $0.2mA$	30	k Ω
Impedance Pin ⁴⁰	Z_{40}	$V_{CC1,2} = 5V$, $V_{CC3} = 9V$ $I_{15} = 10mA$ $I_{40} = -50$ to $+50 \mu A$	18	k Ω
Impedance Pin ⁵¹	Z_{51}	$V_{CC1,2} = 5V$, $V_{CC3} = 9V$ $I_{15} = 10mA$ $I_{51} = -50$ to $+50 \mu A$	27	k Ω
Impedance Pin ⁵⁷	Z_{57}	$V_{CC1,2} = 5V$, $V_{CC3} = 9V$ $I_{15} = 10mA$ $I_{57} = I_{40} = -50$ to $+50 \mu A$	21	k Ω
Impedance Pin ⁶³	Z_{63}	$V_{CC1,2} = 5V$, $V_{CC3} = 9V$ $I_{15} = 10mA$ $I_{63} = -50$ to $+50 \mu A$	27	k Ω
Y Signal Processing Circuit				
Y input signal	e_y	Input; Pin ⁴³ positive polarity	0.3 to 0.8	V_{P-P}
Black level correction start point	BL_{star}	$V_{in} = 0.5V_{P-P}$, $R_{44} = 47k\Omega$ Cont; max.	50	IRE
Picture quality variable range (2)	$\frac{AS_{max}}{AS_{min}}$	$f = 4.0MHz$ Aperture; min. to max.	14.0	dB
APL detection voltage	V_{APL1}	Cont; max., Bright; min. $V_{in} = 0.5V_{P-P}$, APL = 100%	2.5	V
APL detection voltage ratio	V_{APL2}	Cont; max., Bright; min. $V_{in} = 0.5V_{P-P}$, APL = 50%	0.5	times
White peak limiter video voltage gain when operating	WPL	Cont; max., Bright; min. WPL start; OPEN APL Det. terminal 0V	9.0	times
White peak limiter (W.P.L) start point	WPL_{star}	Cont; max., Aperture; min. $V_{in} = 0.5V_{P-P}$ APL Det. pin 0V $R_{41} = 100k\Omega$	45	IRE
DC restoration factor	$T_{DC(2)}$	Cont; typ., Aperture; min. APL 10 to 90% APL Det. resistor; 15k Ω DC restoration factor correction resistor; 33k Ω	120	%

Note) The above characteristics are only theoretical values on design, and are not entirely guaranteed by the inspection.

■ Electrical Characteristics (Design reference value, Ta=25±2 °C)

Parameter	Symbol	Condition	Reference value	Unit
Contrast fluctuation due to variable picture quality	ΔV_{CA}	Video input ; steps wave $V_{in}=0.3V_{P-P}$ Cont ; typ. Aperture ; min. to max.	30	mV
Brightness fluctuation due to variable picture quality	ΔV_{BA}	Aperture ; min. to max. Bright ; typ.	3	mV
Brightness fluctuation due to the variable contrast	ΔV_{BC}	Aperture ; max. Cont ; min. to max.	3	mV
Video output (E_0) supply voltage dependency	$\frac{\Delta E_0}{\Delta V}$	$V_{CC3}=+10\%, -10\%$ Video output level variation ratio in case of variable	0.15	V/V
Video voltage gain difference	Δe_G	Delay line ; gain difference between DL3 mode and DL1 mode	1.01	times
Video frequency characteristics (2)	$f_{YC(2)}$	Delay line ; DL1 mode	-1.8	dB
Input terminal current	I_{43}	Inflow current when $V_{43}=4.5V$ applied	11	μA
Y signal SN ratio	S/N	Cont ; max. Aperture ; min., Bright ; typ.	59	dB
Brightness relative control sensitivity	BR_d	Bright ; 3.5V, 2.5V Bright control sensitivity ratio	100	%

On-screen Circuit

C-Y/Y ratio	R_{CY}	Measure B_{OUT} when color bar is input.	1.35	times
Ambient temperature dependency of E_c	$\frac{\Delta E_c}{\Delta T}$	Ta = -20 to +70°C Variation quantity of each output level	-1.8	mV/°C
Supply voltage dependency of E_c	$\frac{\Delta E_c}{\Delta V}$	$V_{CC3}=+10\%, -10\%$ Variation ratio of pedestal level when V_{CC3} variation is -20 to 70°C	0.4	V/V
On-screen BLK output voltage	V_{CBLK}	$V_S=3.0V$, Bright ; typ. Pin②, ⑦, ⑧ voltage during BLK period	1.0	V

Color Signal Processing Circuit

f_0 ambient temperature dependency	Δf_{CO-T}	Ta = -20 to +70°C Color signal no input	-2.85	Hz/°C
VCO control sensitivity	β	Burst Gate ; OFF	2.8	Hz/mV
APC phase detection sensitivity	μ	Killer ; OFF	18.3	$\frac{mV}{deg}$
Phase hold characteristics	$\Delta \Phi$	$\frac{1}{\mu \cdot \beta} \times 100$	1.95	$\frac{100deg}{Hz}$
Maximum color difference output	e_{OM}	Color bar signal (burst - 150mV _{P-P}) Cont, Color ; max.	6.0	V _{P-P}
Color difference output ambient temperature dependency	Δe_{O-T}	Ta = -20 to +70°C Ta = 25°C to be a center	±100	mV _{P-P}
Color difference output supply voltage dependency	Δe_{O-VCC}	$V_{CC3}=+10\%, -10\%$ Variation width for $V_{CC3}=typ.$	±0	mV
Career filter frequency characteristics	e_{cf}	Frequency at which to be -3dB at color output terminal	1.0	MHz
2nd-order HPF amplitude characteristics	V_{H2}	$V_{in}=300mV_{P-P}$, $f=3.58MHz$	-6	dB
2nd-order HPF delay amount	τ_{H2}	$V_{in}=300mV_{P-P}$, $f=3.58MHz$	60	ns
6th-order HPF amplitude characteristics	V_{H6}	$V_{in}=300mV_{P-P}$, $f=3.58MHz$	-6	dB
6th-order HPF delay quantity	τ_{H6}	$V_{in}=300mV_{P-P}$, $f=3.58MHz$	215	ns

Horizontal Signal Processing

Synchronous separable input	V_{IN}		1.0 to 2.5	V _{P-P}
Horizontal oscillation frequency control sensitivity	β	$V_{18.6}=4.0$ to 4.2V	1.44	Hz/mV
f_{HO} ambient temperature dependency	$\frac{\Delta f_{HO}}{\Delta T_a}$	Ta = -20 to +70°C	5.5	Hz/°C

Note) The above characteristics are only theoretical values on design, and are not entirely guaranteed by the inspection.

Electrical Characteristics (cont.) (Design reference value, $T_a = 25 \pm 2 \text{ }^\circ\text{C}$)

Parameter	Symbol	Condition	Reference value	Unit
f_{HO} supply voltage dependency	$\frac{\Delta f_{HO}}{V_{15}}$	$f_{HO(I_{15}=20mA)} - f_{HO(I_{15}=9mA)}$	-2.5	Hz
FBP slice level	f_{th}		2.0	V
Input terminal inflow current	I_{14}	Inflow current when $V_{14}=2V$ applied	12	μA
Phase detector current (1)	$I_{18(1)}$	$V_{CC1\text{ to }3} = \text{typ.}, I_{15} = 10\text{mA}$ $V_{23 \cdot 6} = 1V$	0.45	mA
Phase detector current (2)	$I_{18(2)}$	$V_{CC1\text{ to }3} = \text{typ.}, I_{15} = 10\text{mA}$ $V_{23 \cdot 6} = 5V$	1.85	mA
Vertical Signal Processing				
Vertical pull-in possible input frequency	f_{PV}	$f_H = 15.75\text{kHz}$	60 ± 4	Hz
Vertical BLK pulse width	$\tau_V \cdot \text{BLK}$	$f_H = 15.75\text{kHz}$ ($17/f_H$)	1.08	ms
Vertical BLK level	$V_V \cdot \text{BLK}$	Bright ; typ.	1.0	V
Hold-down blanking start voltage	$V_{\text{HOLD}}(\text{BLK})$	V_{CC} ; typ. Pin⑨ voltage when BLK applied to output when $V_{21}=6V$	3.3	V
Input terminal inflow current	I_{13}	Inflow current when $V_{13}=2V$ applied	12	μA
Vertical oscillation frequency supply voltage dependency	$\frac{\Delta f_{VO}}{V_{CC2}}$	$V_{CC1\text{ to }3} = \text{typ.}, I_{15} = 10\text{mA}$ $V_{CC2} = 4.75 \text{ to } 5.25V$	0	Hz
YC Separation				
YOUT DG	DG_Y	$V_{in} = 2V_{P-P}$, 6dBATT ; ON Pin① input EE mode	2	%
LINEOUT DG	DG_L	$V_{in} = 2V_{P-P}$, Pin⑥ input VCR mode	2	%
LINEOUT DP	DP_L	$V_{in} = 2V_{P-P}$, Pin⑥ input VCR mode	2	deg
Switch Circuit				
Service switch operation	e_{sur}	Cont ; 0V, Bright ; typ.	10	mV_{P-P}
Neck detection operation (1)	V_{nec}	Bright ; max., Cont ; max. Pedestal voltage in neck detection	1.7	V
Neck detection operation (2)	e_{nec}	Bright ; max., Cont ; max. Input sine. wave ; $0.2V_{P-P}$ $f = 2\text{MHz}$ Output signal amplitude in neck detection	10	mV_{P-P}
Neck detection operation (3)	c_{nec}	Cont ; max., Color ; max. Color bar signal burst 150mV_{P-P} Output signal amplitude in neck detection	10	mV_{P-P}
Neck detection operation (4)	O_{nec}	Bright ; max., Cont ; max. $Y_S = 2.5V$, RGB input ; 3V Output DC voltage in neck detection	1.6	V
Blanking stop voltage	BLK_{OFF}	$V_{CC1\text{ to }3}$; typ. Pin⑩ voltage when BLK not applied to output	0.36	V
Burst Gate Pulse				
Burst gate pulse width	τ_{BGP1}		2.8	μs
Burst gate pulse position	τ_{BGP2}	From horizontal sync. signal rear edge at Pin⑭ to burst gate pulse front edge	0.5	μs
External burst gate input pulse high level	V_{BGP1}	External input B.G.P high level at Pin③	2.0 to 3.0	V
External burst gate input pulse low level	V_{BGP2}	External input B.G.P high level at Pin③	0.0 to 1.0	V

Note) The above characteristics are only theoretical values on design, and are not entirely guaranteed by the inspection.

Pin Descriptions



Pin No.	Pin name	Pin No.	Pin name
1	YC separation input	33	3.58MHz oscillation
2	Power supply V_{CC1} (for YC separation)	34	Killer output
3	Equalizer	35	Y_S input
4	Contrast control	36	Killer filter
5	Noise reduction monitor	37	Sub-carrier output
6	GND (for deflection)	38	APL detection filter
7	Notch circuit connection (1)	39	DC regeneration amount correction
8	Image quality control	40	Chroma signal input
9	Notch circuit connection (2)	41	White peak limiter start point adj.
10	Black level detection filter	42	To a capacitor for Y clamp
11	Horizontal blanking pulse input	43	Y signal input
12	Power supply V_{CC2} (for deflection)	44	Black level correction start point adj.
13	Ver. sync. separation input	45	YC separation Y signal output
14	Hor. sync. separation input	46	Color control
15	6.2V zener	47	Line output
16	Ver. pulse output	48	Power supply V_{CC3} (for video/chroma)
17	504kHz (32 f_H) oscillation	49	YC separation chroma signal output
18	Hor. AFC filter	50	Tint control
19	Hold down input	51	PB chroma input
20	Ver. integral filter	52	GND (for separation of YC/video/chroma)
21	Hold down ref. voltage	53	S_5 & external burst gate input
22	Hor. drive pulse output	54	S_4
23	Hor. AFC phase Det. sensibility adj.	55	Comb filter output
24	FBP input for phase comparison	56	MUTE
25	Lock Det. filter	57	1H delay line connection (1)
26	B output	58	S_3
27	G output	59	1H delay line connection (2)
28	R output	60	S_2
29	B input	61	PB line signal input
30	G input	62	S_1
31	R input	63	Comb filter input
32	Chroma APC filter	64	Brightness control

ICs for
TV

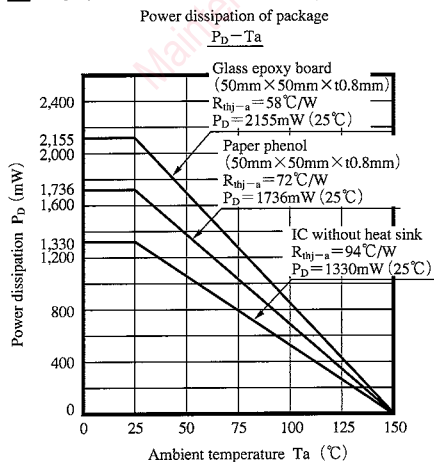

Reference

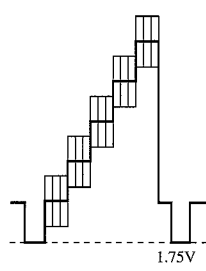
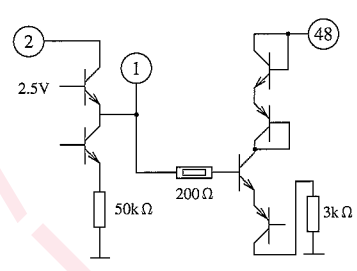
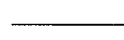

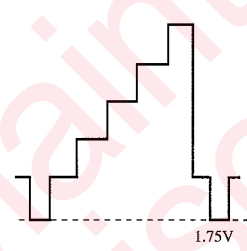
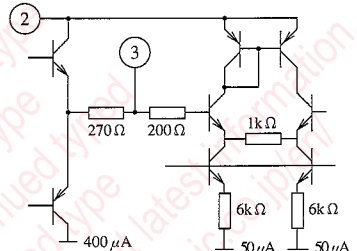
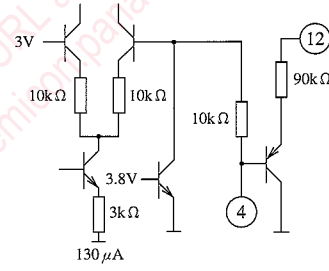
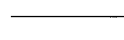
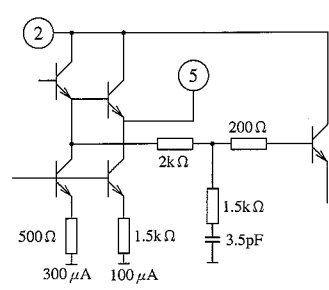
Pin Descriptions

Pin No.	Waveform	Description	Equivalent circuit
1		YC separation Composite video input $V_{in} = 1V_{p-p}$ to $2V_{p-p}$	
2		Power supply for YC separation (5V)	
3		Frequency characteristics correction with an external LC network and the 270Ω internal resistor	
4	DC	Contrast control and service switch circuit input When grounded, the service switch circuit operates.	
5		Monitor of noise reduction circuit	

■ Pin Descriptions (cont.)

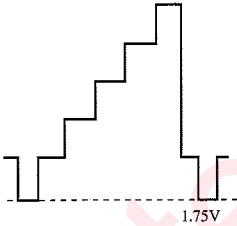
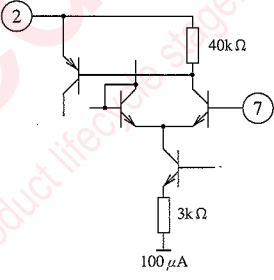
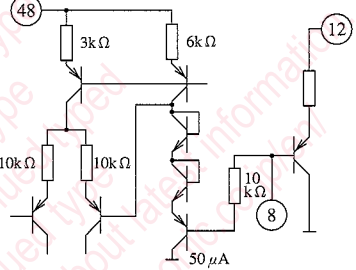
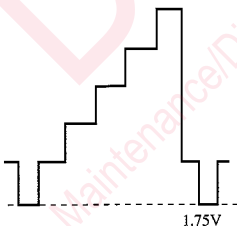
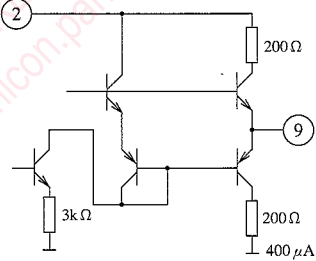
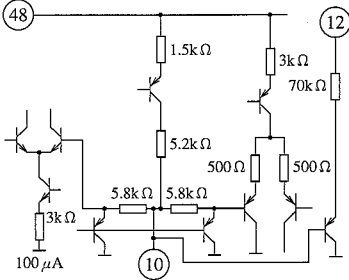
Pin No.	Waveform	Description	Equivalent circuit
6		GND for deflection	
7		Input from an external notch circuit	
8	DC	Sharpness control and neck detection circuit input When grounded, the neck detection circuit operates.	
9		Output to an external notch circuit	
10	DC	Black level detection filter and blanking circuit input When grounded, the blanking-OFF-circuit operates.	

ICs for TV

■ Pin Descriptions (cont.)

Pin No.	Waveform	Description	Equivalent circuit
11		<p>Flyback pulse input and also burst gate pulse monitor (in synchronization with burst gate pulse, current flows out to Pin①).</p>	
12		<p>Power supply for deflection (5V)</p>	
13		<p>Composite sync. signal input for vertical sync. signal separation</p>	
14	<p>Same as the above</p>	<p>Composite sync. signal input for horizontal sync. signal separation</p>	
15	<p>DC</p>	<p>When a current of 9mA or more flows in, the band gap circuit input voltage is regulated to 6.2V.</p>	

■ Pin Descriptions (cont.)

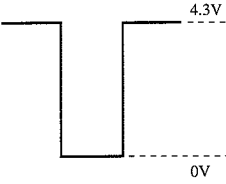
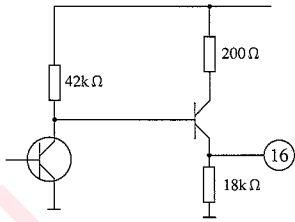
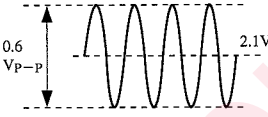
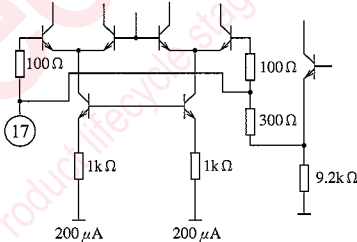
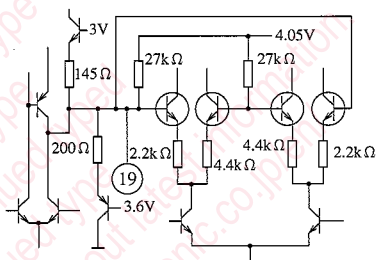
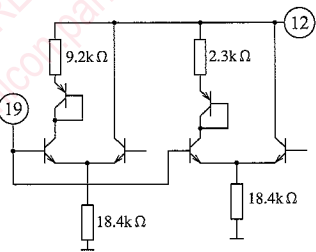
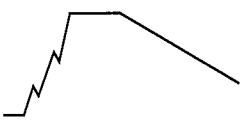
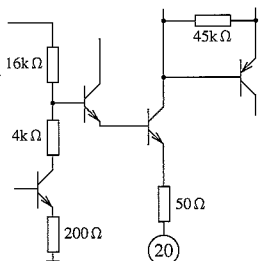
Pin No.	Waveform	Description	Equivalent circuit
16		Vertical pulse output	
17		Oscillation starts when a ceramic oscillator element (504kHz) is connected between GND and this pin.	
18	Approx. 4.1V DC	Horizontal oscillation frequency control and horizontal AFC detection	
19	DC	Xray protection-circuit input	
20		To a vertical sync.-separation integral-filter	

ICs for TV

■ Pin Descriptions (cont.)

Pin No.	Waveform	Description	Equivalent circuit
21	DC	Hold down reference voltage supply	
22		Horizontal pulse output (50% duty cycle)	
23	DC	Horizontal AFC phase det. sensitivity adj.	
24		SAW input for horizontal AFC comparison (Created from integrated F.B.P.)	
25	Locked condition : 6V DC, Unlocked condition : 0V DC	Lock detection filter pin. In synchronization with horizontal sync. signal, current flows out and is filtered into DC by an external CR network.	

Pin Descriptions (cont.)

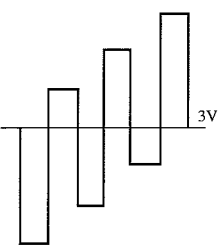
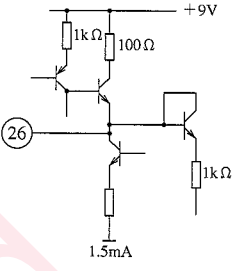
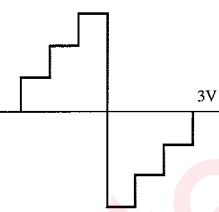
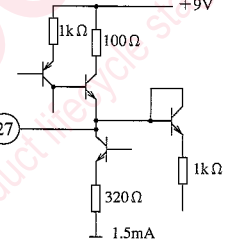
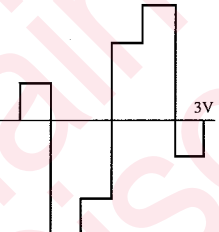
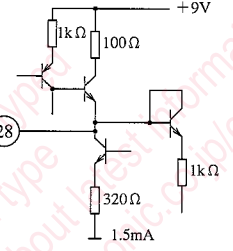
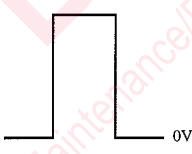
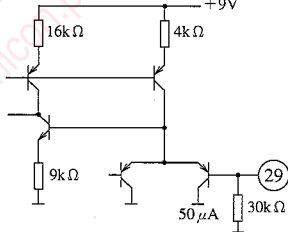
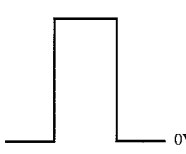
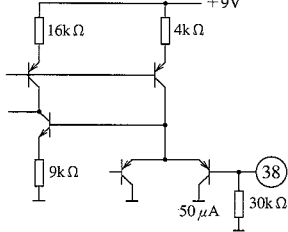
Pin No.	Waveform	Description	Equivalent circuit
26		Primary color B output Internal and external signals are switched by Y _s (Pin35).	
27		Primary color G output Internal and external signals are switched by Y _s (Pin35).	
28		Primary color R output Internal and external signals are switched by Y _s (Pin35).	
29		External B input	
30		External G input	

ICs for TV

■ Pin Descriptions (cont.)

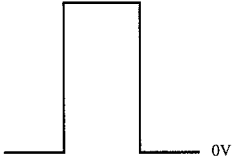
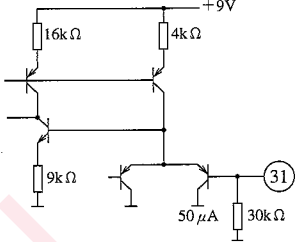
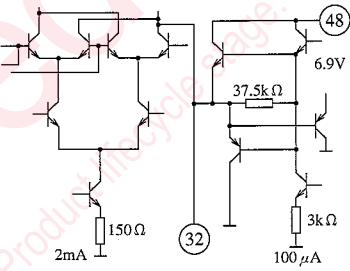
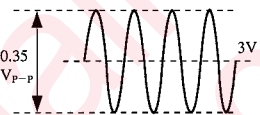
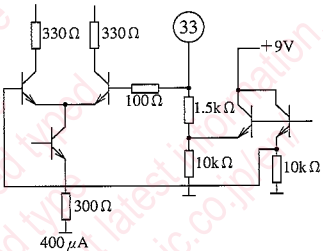
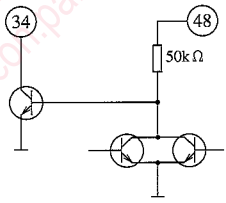
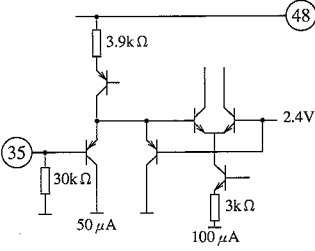
Pin No.	Waveform	Description	Equivalent circuit
31		External R input	
32	Approx. 6.2V DC	Chroma oscillation frequency control and chroma APC detection	
33		Connect a crystal between this pin and GND, and oscillation of 3.58MHz starts.	
34	DC	Killer output which corresponds to killer-on/off to turn on or off the output stage transistor	
35	DC	Internal/external signal switching High : External signal Low : Internal signal	

Pin Descriptions (cont.)

Pin No.	Waveform	Description	Equivalent circuit
36	DC	Killer filter pin. Filtered and became DC-voltage by external capacitor. High : Killer ON Low : Killer OFF	
37		Sub-carrier output of the chroma oscillator	
38	DC	Filter pin for detecting Y-signal APL Current flows out corresponding to APL. DC voltage is obtained by filtering the current with an external CR network.	
39	DC	DC regeneration amount correction Corresponding to the current flowing out of this pin, the brightness level of RGB-output-pin rises.	
40		Chroma signal input	



■ Pin Descriptions (cont.)

Pin No.	Waveform	Description	Equivalent circuit
41	DC	<p>A.P.L. linked type. The W.P.L. start point varies depending on the current flowing out of this pin.</p>	
42	DC	To a capacitor for pedestal clamp	
43		Video signals input	
44	DC	Adjustment of black-level-compensation-start-point. The higher the flowing current out of this pin, the nearer the white side signal level to the black side level.	
45		YC-separation Y-signal output	

Pin Descriptions (cont.)

Pin No.	Waveform	Description	Equivalent circuit
46	DC	Color control	
47		Line output	
48	—	Power supply for YC separation output stage of video and chroma	—
49		YC separation chroma signal output	
50	DC	Tint control	

ICs for TV

■ Pin Descriptions (cont.)

Pin No.	Waveform	Description	Equivalent circuit
51		Chroma signal input for playback	
52		GND for YC-separation of video and chroma	
53		Mode control and external burst gate pulse input	
54		Mode control	
55		COMB filter output	

■ Pin Descriptions (cont.)

Pin No.	Waveform	Description	Equivalent circuit
56	DC	Mode control	
57		Input from 1H-delay-line	
58	DC	Mode control	
59		Output to 1H-delay-line	
60	DC	Mode control Three-value control	



■ Pin Descriptions (cont.)

Pin No.	Waveform	Description	Equivalent circuit
61		<p>Line signal input for playback</p> <p>$V_{in} = 1V_{P-P}$</p>	
62	DC	Mode control	
63		COMB-filter input	
64	DC	Brightness control	

Request for your special attention and precautions in using the technical information and semiconductors described in this book

- (1) If any of the products or technical information described in this book is to be exported or provided to non-residents, the laws and regulations of the exporting country, especially, those with regard to security export control, must be observed.
- (2) The technical information described in this book is intended only to show the main characteristics and application circuit examples of the products. No license is granted in and to any intellectual property right or other right owned by Panasonic Corporation or any other company. Therefore, no responsibility is assumed by our company as to the infringement upon any such right owned by any other company which may arise as a result of the use of technical information described in this book.
- (3) The products described in this book are intended to be used for standard applications or general electronic equipment (such as office equipment, communications equipment, measuring instruments and household appliances).
Consult our sales staff in advance for information on the following applications:
 - Special applications (such as for airplanes, aerospace, automobiles, traffic control equipment, combustion equipment, life support systems and safety devices) in which exceptional quality and reliability are required, or if the failure or malfunction of the products may directly jeopardize life or harm the human body.
 - Any applications other than the standard applications intended.
- (4) The products and product specifications described in this book are subject to change without notice for modification and/or improvement. At the final stage of your design, purchasing, or use of the products, therefore, ask for the most up-to-date Product Standards in advance to make sure that the latest specifications satisfy your requirements.
- (5) When designing your equipment, comply with the range of absolute maximum rating and the guaranteed operating conditions (operating power supply voltage and operating environment etc.). Especially, please be careful not to exceed the range of absolute maximum rating on the transient state, such as power-on, power-off and mode-switching. Otherwise, we will not be liable for any defect which may arise later in your equipment.
 - Even when the products are used within the guaranteed values, take into the consideration of incidence of break down and failure mode, possible to occur to semiconductor products. Measures on the systems such as redundant design, arresting the spread of fire or preventing glitch are recommended in order to prevent physical injury, fire, social damages, for example, by using the products.
- (6) Comply with the instructions for use in order to prevent breakdown and characteristics change due to external factors (ESD, EOS, thermal stress and mechanical stress) at the time of handling, mounting or at customer's process. When using products for which damp-proof packing is required, satisfy the conditions, such as shelf life and the elapsed time since first opening the packages.
- (7) This book may be not reprinted or reproduced whether wholly or partially, without the prior written permission of our company.