

## CeNtRa Varistor

Varistor are voltage dependent, nonlinear device which have an electrical behavior similar to back-to-back zener diodes.

CNR series zinc oxide varistor are nonlinear resistors, consisting main of zinc oxide and several kinds of metal oxide additive.

They are bilateral and symmetrical V-I characteristics curve and unparalleled large peak current capability are used for absorption of transient voltage, suppression of pulse noise and circuit voltage stabilization.

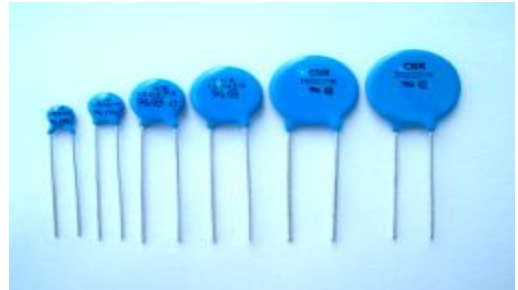

### Applications

- Surge Protection in consumer electronics
  - industrial electronics
  - telephone and telecommunication systems
  - automobile equipments
  - measuring and controller systems
  - electronic home appliances
  - gas and petroleum appliances
- Absorption of switching surge from various kinds of relays and electro-magnetic valves.
- Electrostatic discharge an spike noise suppression.
- Protection of various kinds of transistors, diodes, ICs, thyristors, triac semiconductors, and etc.
- Automobile control system such as transistorized ignition system and electronic fuel injection system, and etc.

### Features

- Fast response
- Excellent voltage ratio
- High stabilization for circuit voltage
- Unparalleled absorption for transient voltage characteristics
- Bilateral and symmetrical V-I Characteristics curve

### Related Standards

- UL1414, UL1449(2nd Edition), CSA, VDE

### Explanation of Part Numbers

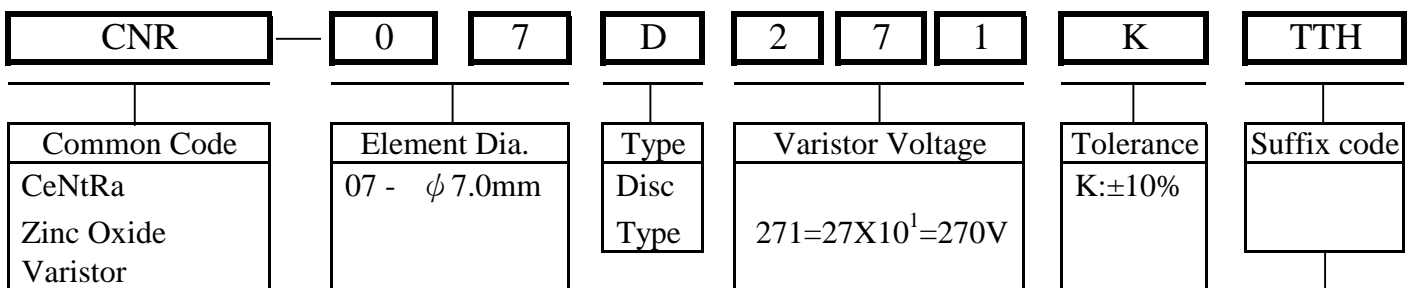

Space: Standard Straight lead/Bulk Packing  
 TRS: Straight lead/Tape&Reel Packing  
 TRK: Type I Crimped lead/Tape&Reel Packing  
 TIK: Type II Crimped lead/Tape&Reel Packing  
 TRH: Type III Crimped lead/Tape&Reel Packing  
 BTS: Straight lead/Flat Box Packing  
 BTK: Type I lead/Flat Box Packing

A: Silver Disc  
 BTI: Type II lead/Flat Box packing  
 BTH: Type III lead/Flat Box Packing  
 TTS: Straight Cut Lead /Bulk Packing  
 TTK: Type I Cut Lead /Bulk Packing  
 TTI: Type II Cut Lead /Bulk Packing  
 TTH: Type III Cut Lead /Bulk Packing

## Device Ratings and Characteristics

Part No.	Maximum Allowable Voltage		Varistor Voltage (@0.1mA)			Clamping Voltage @ Test Current (8/20µs)		Maximum Energy (J)	Maximum Peak Current (8/20µs) (A)	Rated Power (W)	Typical Capacitance (@1KHz) (pF)	Standards
	ACrms(V)	DC(V)	Min.	Vb(Vdc)	Max.	Vc(V)	Ip(A)	10/1000µs				
CNR-05D180K	11	14	14.4	18	21.6	44	1	0.4	100	0.01	1600	☆
CNR-05D220K	14	18	18.7	22	26	51	1	0.5	100	0.01	1500	☆
CNR-05D270K	17	22	23	27	31.1	60	1	0.6	100	0.01	1450	☆
CNR-05D330K	20	26	29.5	33	36.5	73	1	0.8	100	0.01	1400	☆
CNR-05D390K	25	31	35	39	46	86	1	0.9	100	0.01	700	☆
CNR-05D470K	30	38	42	47	55	104	1	1.1	100	0.01	650	☆
CNR-05D560K	35	45	50	56	66	123	1	1.3	100	0.01	600	☆
CNR-05D680K	40	56	61	68	80	150	1	1.6	100	0.01	580	☆
CNR-05D820K	50	66	74	82	90	135	5	2.5	400	0.10	310	☆ ◎
CNR-05D101K	60	85	90	100	110	175	5	3.0	400	0.10	290	☆ ◎
CNR-05D121K	75	100	108	120	132	210	5	4.0	400	0.10	270	☆ ◎
CNR-05D151K	95	125	135	150	165	260	5	4.8	400	0.10	240	☆ ◎
CNR-05D181K	115	150	162	180	198	325	5	5.9	400	0.10	140	☆ ◎
CNR-05D201K	130	175	185	200	225	330	5	6.5	400	0.10	120	☆ △ ※ ◎
CNR-05D221K	140	180	198	220	242	360	5	7.0	400	0.10	110	☆ △ ※ ◎
CNR-05D241K	150	200	216	240	264	395	5	8.0	400	0.10	110	☆ △ ※ ◎
CNR-05D271K	180	230	247	270	303	475	5	8.5	400	0.10	100	☆ △ ※ ◎
CNR-05D301K	195	250	270	300	330	505	5	9.0	400	0.10	100	☆ △ ※ ◎
CNR-05D331K	210	275	297	330	363	540	5	10.0	400	0.10	90	☆ △ ※ ◎
CNR-05D361K	230	300	324	360	396	620	5	10.0	400	0.10	80	☆ △ ※ ◎
CNR-05D391K	250	320	351	390	429	675	5	12.0	400	0.10	80	☆ △ ※ ◎
CNR-05D431K	275	350	387	430	473	745	5	13.0	400	0.10	70	☆ △ ※ ◎
CNR-05D471K	300	385	423	470	517	775	5	15.0	400	0.10	70	☆ △ ※ ◎
CNR-05D511K	320	410	459	510	561	880	5	15.0	400	0.10	65	☆ △ ※ ◎
CNR-05D561K	350	460	504	560	616	940	5	15.0	400	0.10	65	☆ △ ※ ◎
CNR-05D621K	385	505	558	620	682	1050	5	15.0	400	0.10	65	☆ △ ※ ◎
CNR-05D681K	420	560	612	680	748	1150	5	15.0	400	0.10	60	☆ △ ※ ◎
CNR-05D751K	460	615	675	750	825	1290	5	15.0	400	0.10	60	☆ △ ※ ◎

### Related Standards

Standard No.	UL 1414	UL 1449(2nd Edition)	CSA	VDE
Title	Across-The-Line Components	Transient Voltage Surge Suppressors	Accessories and Parts for Electronic Products	Varistors for use in Electronic equipment
File No.	E165143	E150709	LR109736-1	21557-4790-001
ML File No.	N/A	E223465	187409-1424357	40005991
Symbols	△	☆	※	◎

### Selection guide

1. Determine the necessary steady-state voltage (working voltage).
2. Establish the transient energy absorbed by the varistor
3. Calculate the peak transient current through the varistor
4. Determine power dissipation requirement.
5. Select a model to provide the required voltage-clamping characteristics



# APPROVAL SHEET

## Device Ratings and Characteristics

Part No.	Maximum Allowable Voltage		Varistor Voltage (@1mA)			Clamping Voltage @ Test Current (8/20µs)		Maximum Energy (J)	Maximum Peak Current (8/20µs)	Rated Power (W)	Typical Capacitance (@1KHz) (pF)	Standards
	ACrms(V)	DC(V)	Min.	Vb(Vdc)	Max.	Vc(V)	Ip(A)	10/1000µs	(A)	(W)	(pF)	
CNR-07D180K	11	14	14.4	18	21.6	42	2.5	0.9	250	0.02	3800	☆
CNR-07D220K	14	18	18.7	22	26	47	2.5	1.1	250	0.02	3600	☆
CNR-07D270K	17	22	23	27	31.1	53	2.5	1.4	250	0.02	3400	☆
CNR-07D330K	20	26	29.5	33	36.5	65	2.5	1.7	250	0.02	2900	☆
CNR-07D390K	25	31	35	39	43	77	2.5	2.1	250	0.02	1600	☆
CNR-07D470K	30	38	42	47	52	93	2.5	2.5	250	0.02	1550	☆
CNR-07D560K	35	45	50	56	62	110	2.5	3.1	250	0.02	1500	☆
CNR-07D680K	40	56	61	68	75	135	2.5	3.6	250	0.02	1200	☆
CNR-07D820K	50	66	74	82	90	135	10	5.5	1200	0.25	860	☆ ◎
CNR-07D101K	60	85	90	100	110	165	10	6.5	1200	0.25	750	☆ ◎
CNR-07D121K	75	100	108	120	132	200	10	7.8	1200	0.25	530	☆ ◎
CNR-07D151K	95	125	135	150	165	250	10	9.7	1200	0.25	410	☆ ◎
CNR-07D181K	115	150	162	180	198	300	10	11.7	1200	0.25	300	☆ ◎
CNR-07D201K	130	175	185	200	225	330	10	13.0	1200	0.25	250	☆ △ ※ ◎
CNR-07D221K	140	180	198	220	242	360	10	14.0	1200	0.25	250	☆ △ ※ ◎
CNR-07D241K	150	200	216	240	264	395	10	15.0	1200	0.25	240	☆ △ ※ ◎
CNR-07D271K	175	225	247	270	303	455	10	18.0	1200	0.25	220	☆ △ ※ ◎
CNR-07D301K	195	250	270	300	330	500	10	20.0	1200	0.25	190	☆ △ ※ ◎
CNR-07D331K	210	275	297	330	363	540	10	25.0	1200	0.25	180	☆ △ ※ ◎
CNR-07D361K	230	300	324	360	396	595	10	25.0	1200	0.25	170	☆ △ ※ ◎
CNR-07D391K	250	320	351	390	429	650	10	25.0	1200	0.25	160	☆ △ ※ ◎
CNR-07D431K	275	350	387	430	473	710	10	28.0	1200	0.25	150	☆ △ ※ ◎
CNR-07D471K	300	385	423	470	517	775	10	30.0	1200	0.25	130	☆ △ ※ ◎
CNR-07D511K	320	410	459	510	561	845	10	30.0	1200	0.25	120	☆ △ ※ ◎
CNR-07D561K	350	460	504	560	616	915	10	30.0	1200	0.25	120	☆ △ ※ ◎
CNR-07D621K	385	505	558	620	682	1025	10	30.0	1200	0.25	120	☆ △ ※ ◎
CNR-07D681K	420	560	612	680	748	1120	10	30.0	1200	0.25	110	☆ △ ※ ◎
CNR-07D751K	460	615	675	750	825	1240	10	33.0	1200	0.25	100	☆ △ ※ ◎
CNR-07D781K	485	640	702	780	858	1290	10	37.0	1200	0.25	90	☆ △ ※ ◎
CNR-07D821K	510	670	738	820	902	1355	10	40.0	1200	0.25	90	☆ △ ※ ◎

\* Special for Brightking

## Related Standards

Standard No.	UL 1414	UL 1449(2nd Edition)	CSA	VDE
Title	Across-The-Line Components	Transient Voltage Surge Suppressors	Accessories and Parts for Electronic Products	Varistors for use in Electronic equipment
File No.	E165143	E150709	LR109736-1	21557-4790-001
ML File No.	N/A	E223465	187409-1424357	40005991
Symbols	△	☆	※	◎



# APPROVAL SHEET

## Device Ratings and Characteristics

Part No.	Maximum Allowable Voltage		Varistor Voltage (@1mA)			Clamping Voltage @ Test Current (8/20μs)		Maximum Energy (J)	Maximum Peak Current (8/20μs)	Rated Power (W)	Typical Capacitance (@1KHz) (pF)	Standards
	ACrms(V)	DC(V)	Min.	Vb(Vdc)	Max.	Vc(V)	Ip(A)	10/1000μs	(A)			
CNR-10D180K	11	14	14.4	18	21.6	39	5	2.1	500	0.05	16000	☆
CNR-10D220K	14	18	18.7	22	26	43	5	2.5	500	0.05	11000	☆
CNR-10D270K	17	22	23	27	31.1	53	5	3.0	500	0.05	8000	☆
CNR-10D330K	20	26	29.5	33	36.5	65	5	4.0	500	0.05	6300	☆
CNR-10D390K	25	31	35	39	43	77	5	4.6	500	0.05	5200	☆
CNR-10D470K	30	38	42	47	52	93	5	5.5	500	0.05	4600	☆
CNR-10D560K	35	45	50	56	62	110	5	7.0	500	0.05	3750	☆
CNR-10D680K	40	56	61	68	75	135	5	8.2	500	0.05	2800	☆
CNR-10D820K	50	66	74	82	90	135	25	12.0	2500	0.40	1920	☆ ◎
CNR-10D101K	60	85	90	100	110	165	25	15.0	2500	0.40	1800	☆ ◎
CNR-10D121K	75	100	108	120	132	200	25	18.0	2500	0.40	1500	☆ ◎
CNR-10D151K	95	125	135	150	165	250	25	22.0	2500	0.40	1200	☆ ◎
CNR-10D181K	115	150	162	180	198	300	25	27.0	2500	0.40	620	☆ ◎
CNR-10D201K	130	175	185	200	225	340	25	30.0	2500	0.40	570	☆ △ ※ ◎
CNR-10D221K	140	180	198	220	242	360	25	32.0	2500	0.40	560	☆ △ ※ ◎
CNR-10D241K	150	200	216	240	264	395	25	35.0	2500	0.40	550	☆ △ ※ ◎
CNR-10D271K	180	230	247	270	303	455	25	40.0	2500	0.40	530	☆ △ ※ ◎
CNR-10D301K	195	250	270	300	330	500	25	42.0	2500	0.40	500	☆ △ ※ ◎
CNR-10D331K	210	275	297	330	363	540	25	47.0	2500	0.40	470	☆ △ ※ ◎
CNR-10D361K	230	300	324	360	396	595	25	47.0	2500	0.40	450	☆ △ ※ ◎
CNR-10D391K	250	320	351	390	429	650	25	60.0	2500	0.40	430	☆ △ ※ ◎
CNR-10D431K	275	350	387	430	473	710	25	65.0	2500	0.40	400	☆ △ ※ ◎
CNR-10D471K	300	385	423	470	517	775	25	70.0	2500	0.40	300	☆ △ ※ ◎
CNR-10D511K	320	420	459	510	561	845	25	70.0	2500	0.40	260	☆ △ ※ ◎
CNR-10D561K	350	460	504	560	616	915	25	70.0	2500	0.40	200	☆ △ ※ ◎
CNR-10D621K	385	505	558	620	682	1025	25	70.0	2500	0.40	170	☆ △ ※ ◎
CNR-10D681K	420	560	612	680	748	1120	25	70.0	2500	0.40	160	☆ △ ※ ◎
CNR-10D751K	460	615	675	750	825	1240	25	75.0	2500	0.40	150	☆ △ ※ ◎
CNR-10D781K	485	640	702	780	858	1290	25	80.0	2500	0.40	150	☆ △ ※ ◎
CNR-10D821K	510	670	738	820	902	1355	25	85.0	2500	0.40	150	☆ △ ※ ◎
CNR-10D911K	550	745	819	910	1001	1500	25	93.0	2500	0.40	140	☆ △ ※ ◎
CNR-10D102K	625	825	900	1000	1100	1650	25	102.0	2500	0.40	140	☆ △ ※ ◎
CNR-10D112K	680	895	990	1100	1210	1815	25	115.0	2500	0.40	130	☆ ※ ◎

## Related Standards

Standard No.	UL 1414	UL 1449(2nd Edition)	CSA	VDE
Title	Across-The-Line Components	Transient Voltage Surge Suppressors	Accessories and Parts for Electronic Products	Varistors for use in Electronic equipment
File No.	E165143	E150709	LR109736-1	21557-4790-001
ML File No.	N/A	E223465	187409-1424357	40005991
Symbols	△	☆	※	◎



# APPROVAL SHEET

## Device Ratings and Characteristics

Part No.	Maximum Allowable Voltage		Varistor Voltage (@1mA)			Clamping Voltage @ Test Current (8/20µs)		Maximum Energy (J)	Maximum Peak Current (8/20µs) (A)	Rated Power (W)	Typical Capacitance (@1KHz) (pF)	Standards
	ACrms(V)	DC(V)	Min.	Vb(Vdc)	Max.	Vc(V)	Ip(A)	10/1000µs				
CNR-14D180K	11	14	14.4	18	21.6	39	10	4.0	1000	0.1	25000	☆
CNR-14D220K	14	18	18.7	22	26	43	10	5.0	1000	0.1	20000	☆
CNR-14D270K	17	22	23	27	31.1	53	10	6.0	1000	0.1	16000	☆
CNR-14D330K	20	26	29.5	33	36.5	65	10	7.5	1000	0.1	12200	☆
CNR-14D390K	25	31	35	39	43	77	10	8.6	1000	0.1	7000	☆
CNR-14D470K	30	38	42	47	52	93	10	10.0	1000	0.1	6750	☆
CNR-14D560K	35	45	50	56	62	110	10	11.0	1000	0.1	6500	☆
CNR-14D680K	40	56	61	68	75	135	10	14.0	1000	0.1	5500	☆
CNR-14D820K	50	66	74	82	90	135	50	22.0	4500	0.6	4300	☆ ◎
CNR-14D101K	60	85	90	100	110	165	50	28.0	4500	0.6	3500	☆ ◎
CNR-14D121K	75	100	108	120	132	200	50	32.0	4500	0.6	2500	☆ ◎
CNR-14D151K	95	125	135	150	165	250	50	40.0	4500	0.6	3100	☆ ◎
CNR-14D181K	115	150	162	180	198	300	50	50.0	4500	0.6	1250	☆ ◎
CNR-14D201K	130	175	185	200	225	330	50	57.0	4500	0.6	1150	☆ △ ※ ◎
CNR-14D221K	140	180	198	220	242	360	50	60.0	4500	0.6	1100	☆ △ ※ ◎
CNR-14D241K	150	200	216	240	264	395	50	63.0	4500	0.6	1050	☆ △ ※ ◎
CNR-14D271K	180	230	247	270	303	455	50	70.0	4500	0.6	1000	☆ △ ※ ◎
CNR-14D301K	195	250	270	300	330	500	50	73.0	4500	0.6	900	☆ △ ※ ◎
CNR-14D331K	210	275	297	330	363	540	50	93.0	4500	0.6	850	☆ △ ※ ◎
CNR-14D361K	230	300	324	360	396	595	50	93.0	4500	0.6	800	☆ △ ※ ◎
CNR-14D391K	250	320	351	390	429	650	50	100.0	4500	0.6	800	☆ △ ※ ◎
CNR-14D431K	275	350	387	430	473	710	50	115.0	4500	0.6	650	☆ △ ※ ◎
CNR-14D471K	300	385	423	470	517	775	50	125.0	4500	0.6	550	☆ △ ※ ◎
CNR-14D511K	320	420	459	510	561	845	50	125.0	4500	0.6	450	☆ △ ※ ◎
CNR-14D561K	350	460	504	560	616	915	50	125.0	4500	0.6	400	☆ △ ※ ◎
CNR-14D621K	385	505	558	620	682	1025	50	125.0	4500	0.6	350	☆ △ ※ ◎
CNR-14D681K	420	560	612	680	748	1120	50	130.0	4500	0.6	350	☆ △ ※ ◎
CNR-14D751K	460	615	675	750	825	1240	50	143.0	4500	0.6	330	☆ △ ※ ◎
CNR-14D781K	485	640	702	780	858	1290	50	148.0	4500	0.6	330	☆ △ ※ ◎
CNR-14D821K	510	675	738	820	902	1355	50	157.0	4500	0.6	330	☆ △ ※ ◎
CNR-14D911K	550	745	819	910	1001	1500	50	175.0	4500	0.6	300	☆ △ ※ ◎
CNR-14D102K	625	825	900	1000	1100	1650	50	190.0	4500	0.6	300	☆ △ ※ ◎
CNR-14D112K	680	895	990	1100	1210	1815	50	213.0	4500	0.6	200	☆ ※ ◎

## Related Standards

Standard No.	UL 1414	UL 1449(2nd Edition)	CSA	VDE
Title	Across-The-Line Components	Transient Voltage Surge Suppressors	Accessories and Parts for Electronic Products	Varistors for use in Electronic equipment
File No.	E165143	E150709	LR109736-1	21557-4790-001
ML File No.	N/A	E223465	187409-1424357	40005991
Symbols	△	☆	※	◎



# APPROVAL SHEET

## Device Ratings and Characteristics

Part No.	Maximum Allowable Voltage		Varistor Voltage (@1mA)			Clamping Voltage @ Test Current (8/20µs)		Maximum Energy (J)	Maximum Peak Current (8/20µs)	Rated Power (W)	Typical Capacitance (@1KHz)	Standards
	ACrms(V)	DC(V)	Min.	Vb(Vdc)	Max.	Vc(V)	Ip(A)	10/1000µs	(A)	(pF)		
CNR-18D180K	11	14	14.4	18	21.6	39	15	8.3	2000	0.15	36400	☆
CNR-18D220K	14	18	18.7	22	26	43	15	10.4	2000	0.15	27300	☆
CNR-18D270K	17	22	23	27	31.1	53	15	12.5	2000	0.15	22290	☆
CNR-18D330K	20	26	29.5	33	36.5	65	15	15.6	2000	0.15	18200	☆
CNR-18D390K	25	31	35	39	43	77	15	17.9	2000	0.15	12250	☆
CNR-18D470K	30	38	42	47	52	93	15	20.8	2000	0.15	12280	☆
CNR-18D560K	35	45	50	56	62	110	15	22.8	2000	0.15	11100	☆
CNR-18D680K	40	56	61	68	75	135	15	29.1	2000	0.15	10460	☆
CNR-18D820K	50	66	74	82	90	135	75	30.6	5500	0.8	7460	☆ ◎
CNR-18D101K	60	85	90	100	110	165	75	38.9	5500	0.8	7280	☆ ◎
CNR-18D121K	75	100	108	120	132	200	75	44.4	6500	0.8	5000	☆ ◎
CNR-18D151K	95	125	135	150	165	250	75	55.6	6500	0.8	3820	☆ ◎
CNR-18D181K	115	150	162	180	198	300	75	69.4	6500	0.8	2270	☆ ◎
CNR-18D201K	130	175	185	200	225	330	75	79.2	6500	0.8	2100	☆ △ ※ ◎
CNR-18D221K	140	180	198	220	242	360	75	83.3	6500	0.8	2000	☆ △ ※ ◎
CNR-18D241K	150	200	216	240	264	395	75	87.5	6500	0.8	2000	☆ △ ※ ◎
CNR-18D271K	180	230	247	270	303	455	75	97.2	6500	0.8	1910	☆ △ ※ ◎
CNR-18D301K	195	250	270	300	330	500	75	101.4	6500	0.8	1630	☆ △ ※ ◎
CNR-18D331K	210	275	297	330	363	540	75	129.2	6500	0.8	1590	☆ △ ※ ◎
CNR-18D361K	230	300	324	360	396	595	75	129.2	6500	0.8	1540	☆ △ ※ ◎
CNR-18D391K	250	320	351	390	429	650	75	138.9	6500	0.8	1270	☆ △ ※ ◎
CNR-18D431K	275	350	387	430	473	710	75	159.7	6500	0.8	1220	☆ △ ※ ◎
CNR-18D471K	300	385	423	470	517	775	75	173.6	6500	0.8	1090	☆ △ ※ ◎
CNR-18D511K	320	420	459	510	561	845	75	175.0	6500	0.8	950	☆ △ ※ ◎
CNR-18D561K	350	460	504	560	616	915	75	177.8	6500	0.8	770	☆ △ ※ ◎
CNR-18D621K	385	505	558	620	682	1025	75	180.6	6500	0.8	510	☆ △ ※ ◎
CNR-18D681K	420	560	612	680	748	1120	75	182.0	6500	0.8	500	☆ △ ※ ◎
CNR-18D751K	460	615	675	750	825	1240	75	200.2	6500	0.8	480	☆ △ ※ ◎
CNR-18D781K	485	640	702	780	858	1290	75	207.2	6500	0.8	450	☆ △ ※ ◎
CNR-18D821K	510	675	738	820	902	1355	75	219.8	6500	0.8	450	☆ △ ※ ◎
CNR-18D911K	550	745	819	910	1001	1500	75	245.0	6500	0.8	430	☆ △ ※ ◎
CNR-18D102K	625	825	900	1000	1100	1650	75	266.0	6500	0.8	410	☆ △ ※ ◎
CNR-18D112K	680	895	990	1100	1210	1815	75	298.2	6500	0.8	360	※ ◎

## Related Standards

Standard No.	UL 1414	UL 1449(2nd Edition)	CSA	VDE
Title	Across-The-Line Components	Transient Voltage Surge Suppressors	Accessories and Parts for Electronic Products	Varistors for use in Electronic equipment
File No.	E165143	E150709	LR109736-1	21557-4790-001
ML File No.	N/A	E223465	187409-1424357	40005991
Symbols	△	☆	※	◎



# APPROVAL SHEET

## Device Ratings and Characteristics

Part No.	Maximum Allowable Voltage		Varistor Voltage (@1mA)			Clamping Voltage @ Test Current (8/20µs)		Maximum Energy (J)	Maximum Peak Current (8/20µs)	Rated Power (W)	Typical Capacitance (@1KHz)	Standards
	ACrms(V)	DC(V)	Min.	Vb(Vdc)	Max.	Vc(V)	Ip(A)	10/1000µs	(A)	(pF)		
CNR-20D180K	11	14	14.4	18	21.6	39	20	11.0	2000	0.2	40000	☆
CNR-20D220K	14	18	18.7	22	26	43	20	14.0	2000	0.2	30000	☆
CNR-20D270K	17	22	23	27	31.1	53	20	18.0	2000	0.2	24500	☆
CNR-20D330K	20	26	29.5	33	36.5	65	20	23.0	2000	0.2	20000	☆
CNR-20D390K	25	31	35	39	43	77	20	26.0	2000	0.2	13800	☆
CNR-20D470K	30	38	42	47	52	93	20	33.0	2000	0.2	13500	☆
CNR-20D560K	35	45	50	56	62	110	20	41.0	2000	0.2	12200	☆
CNR-20D680K	40	56	61	68	75	135	20	46.0	2000	0.2	11500	☆
CNR-20D820K	50	66	74	82	90	135	100	38.0	6500	1.0	8200	☆ ◎
CNR-20D101K	60	85	90	100	110	165	100	45.0	6500	1.0	8000	☆ ◎
CNR-20D121K	75	100	108	120	132	200	100	55.0	6500	1.0	5500	☆ ◎
CNR-20D151K	95	125	135	150	165	250	100	70.0	6500	1.0	4200	☆ ◎
CNR-20D181K	115	150	162	180	198	300	100	85.0	6500	1.0	2500	☆ ◎
CNR-20D201K	130	175	185	200	225	340	100	95.0	6500	1.0	2300	☆ △ ※ ◎
CNR-20D221K	140	180	198	220	242	360	100	100.0	6500	1.0	2200	☆ △ ※ ◎
CNR-20D241K	150	200	216	240	264	395	100	108.0	6500	1.0	2200	☆ △ ※ ◎
CNR-20D271K	180	230	247	270	303	455	100	127.0	6500	1.0	2100	☆ △ ※ ◎
CNR-20D301K	195	250	270	300	330	500	100	150.0	6500	1.0	1800	☆ △ ※ ◎
CNR-20D331K	210	275	297	330	363	545	100	163.0	6500	1.0	1750	☆ △ ※ ◎
CNR-20D361K	230	300	324	360	396	595	100	163.0	6500	1.0	1700	☆ △ ※ ◎
CNR-20D391K	250	320	351	390	429	650	100	180.0	6500	1.0	1400	☆ △ ※ ◎
CNR-20D431K	275	350	387	430	473	710	100	190.0	6500	1.0	1350	☆ △ ※ ◎
CNR-20D471K	300	385	423	470	517	775	100	220.0	6500	1.0	1200	☆ △ ※ ◎
CNR-20D511K	320	420	459	510	561	845	100	220.0	6500	1.0	1050	☆ △ ※ ◎
CNR-20D561K	350	460	504	560	616	915	100	220.0	6500	1.0	850	☆ △ ※ ◎
CNR-20D621K	385	505	558	620	682	1025	100	220.0	6500	1.0	570	☆ △ ※ ◎
CNR-20D681K	420	560	612	680	748	1120	100	230.0	6500	1.0	550	☆ △ ※ ◎
CNR-20D751K	460	615	675	750	825	1240	100	255.0	6500	1.0	530	☆ △ ※ ◎
CNR-20D781K	485	640	702	780	858	1290	100	265.0	6500	1.0	500	☆ △ ※ ◎
CNR-20D821K	510	675	738	820	902	1355	100	282.0	6500	1.0	500	☆ △ ※ ◎
CNR-20D911K	550	745	819	910	1001	1500	100	310.0	6500	1.0	480	☆ △ ※ ◎
CNR-20D102K	625	825	900	1000	1100	1650	100	342.0	6500	1.0	460	☆ △ ※ ◎
CNR-20D112K	680	895	990	1100	1210	1815	100	383.0	6500	1.0	400	※ ◎

## Related Standards

Standard No.	UL 1414	UL 1449(2nd Edition)	CSA	VDE
Title	Across-The-Line Components	Transient Voltage Surge Suppressors	Accessories and Parts for Electronic Products	Varistors for use in Electronic equipment
File No.	E165143	E150709	LR109736-1	21557-4790-001
ML File No.	N/A	E223465	187409-1424357	40005991
Symbols	△	☆	※	◎

## Dimension of Standard Products

Dimension Table

Unit:mm

Model Symbol	05D	07D	10D	14D	18D	20D
D(max.)	7.5	9.0	14.0	17.5	23.0	25.0
H(max.)	10.0	12.0	17.0	20.5	26.0	28.0
W(±1.0)	5.0	5.0	7.5	7.5	7.5	10.0
L(min.)	25.0	25.0	25.0	25.0	25.0	25.0
d(±0.02)	0.6	0.6	0.8	0.8	0.8	1.0

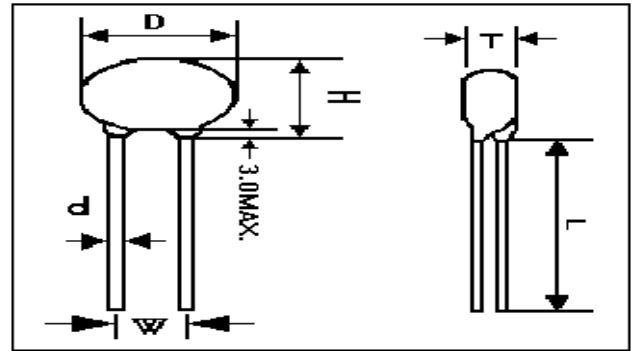

T(max). Table

Unit:mm

Part No	05D	07D	10D	14D	18D	20D
180K	3.3	3.5	3.9	4.0	4.2	4.3
220K	3.6	3.8	4.2	4.3	4.5	4.6
270K	3.8	4.0	4.4	4.5	4.7	4.8
330K	3.3	3.5	3.9	4.0	4.2	4.3
390K	3.5	3.7	4.1	4.2	4.4	4.5
470K	3.7	3.9	4.3	4.4	4.6	4.7
560K	4.0	4.2	4.6	4.7	4.9	5.0
680K	4.3	4.5	4.9	5.0	5.2	5.3
820K	3.3	3.5	3.9	4.0	4.2	4.3
101K	3.6	3.8	4.2	4.3	4.5	4.6
121K	3.8	4.0	4.4	4.5	4.7	4.8
151K	4.1	4.3	4.7	4.8	5.0	5.1
181K	3.2	3.4	3.8	3.9	4.1	4.2
201K	3.3	3.5	3.9	4.0	4.2	4.3
221K	3.4	3.6	4.0	4.1	4.3	4.4
241K	3.5	3.7	4.1	4.2	4.4	4.5
271K	3.7	3.9	4.2	4.3	4.5	4.6

Part No	05D	07D	10D	14D	18D	20D
301K	3.9	4.1	4.3	4.4	4.6	4.7
331K	4.0	4.2	4.5	4.6	4.8	4.9
361K	4.1	4.3	4.7	4.8	5.0	5.1
391K	4.2	4.4	4.8	4.9	5.1	5.2
431K	4.4	4.6	5.0	5.1	5.3	5.4
471K	4.6	4.8	5.2	5.3	5.5	5.6
511K	4.8	5.0	5.3	5.4	5.6	5.7
561K	5.0	5.2	5.5	5.6	5.7	5.9
621K	5.3	5.5	5.7	5.8	6.0	6.1
681K	5.4	5.6	5.8	5.9	6.1	6.2
751K	5.6	5.8	6.0	6.1	6.3	6.4
781K	5.8	6.0	6.3	6.4	6.6	6.7
821K	3.0	6.3	6.5	6.6	6.8	6.9
911K	x	x	6.6	6.7	6.9	7.0
102K	x	x	7.0	7.1	7.3	7.4
112K	x	x	7.4	7.5	7.7	7.9
182K	x	x	x	11.5	11.7	11.9

Packing Quantity

Part No.	Min. Q'ty(pcs) / Bags	Min. Q'ty(pcs) /Inner Box	Min. Q'ty(pcs) /Carton
CNR-05DXXXX	1000	10000	20000
CNR-07DXXXX	1000	5000	10000
CNR-10DXXXX	500	3000	6000
CNR-14DXXXX	500	2000	4000
CNR-18DXXXX	250	1000	2000
CNR-20DXXXX	250	1000	2000



## Crimped Lead Type

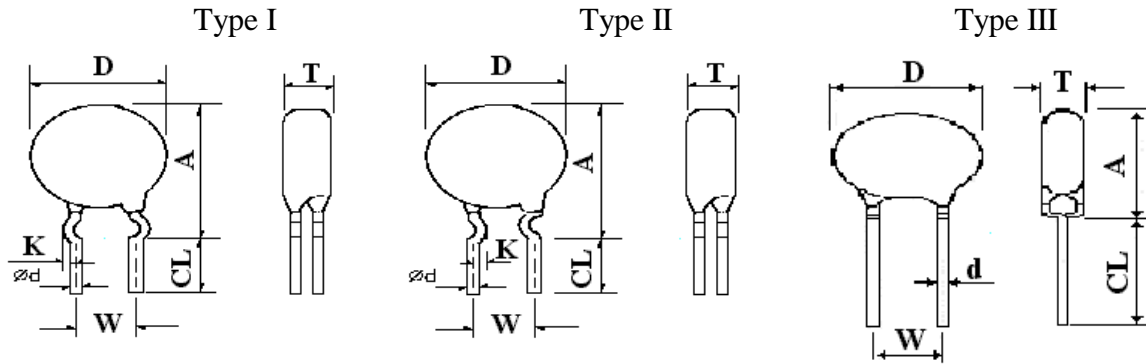

Unit:mm

Symbol		Series	05D Series	07D Series	10D Series	14D Series
A max.	Varistor Voltage	18V to 330V	13.0	15.0	19.5	22.5
	V1mA(V)	360V to 1800V	13.0	15.0	20.5	23.5
Dmax.			7.5	9.0	14.0	17.5
K			1.2±0.4	1.2±0.4	1.4±0.4	1.4±0.4
W			5.0±1.0	5.0±1.0	7.5±1.0	7.5±1.0
CL			5.0±0.5	5.0±0.5	5.0±0.5	5.0±0.5
φ d			0.6	0.6	0.8	0.8

Symbol T : Product thickness please reference dimension of standard products

## Packing Quantity

Cut-off Straight Lead	Cut-off Type I Lead	Cut-off Type II Lead	Cut-off Type III Lead	Min. Q'ty (pcs)/Bags	Min. Q'ty(pcs) /Inner Box	Min. Q'ty(pcs) /Carton
CNR-05DXXXXK-TTS	-TTK	-TTI	-TTH	1000	15000	30000
CNR-07DXXXXK-TTS	-TTK	-TTI	-TTH	1000	15000	30000
CNR-10DXXXXK-TTS	-TTK	-TTI	-TTH	500	5000	10000
CNR-14DXXXXK-TTS	-TTK	-TTI	-TTH	500	3500	7000
CNR-18DXXXXK-TTS	N/A	N/A	N/A	250	1500	3000
CNR-20DXXXXK-TTS	N/A	N/A	N/A	250	1500	3000

## Tape and Reel Fig.

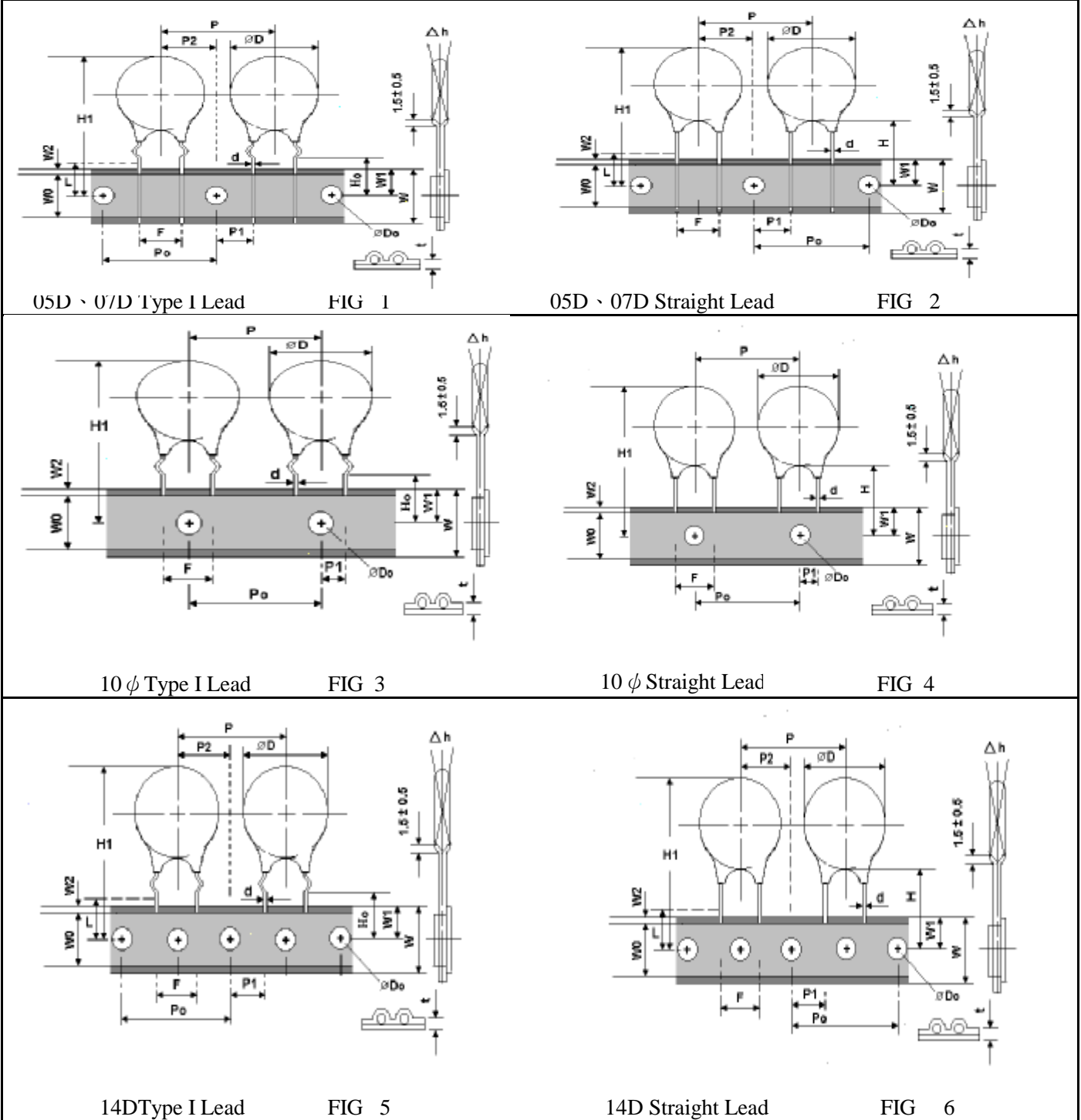

### Taping product ordering Information

Tape & Reel				Flax Box			
Straight Lead	Type I Lead	Type II Lead	Type III Lead	Straight Lead	Type I Lead	Type II Lead	Type III Lead
CNR-05DXXXX-TRS	-TRK	-TRI	-TRH	CNR-05DXXXX-BTS	-BTK	-BTI	-BTH
CNR-07DXXXX-TRS	-TRK	-TRI	-TRH	CNR-07DXXXX-BTS	-BTK	-BTI	-BTH
CNR-10DXXXX-TRS	-TRK	-TRI	-TRH		OUTSIDE	INSIDE	CRIMPED
CNR-14DXXXX-TRS	-TRK	-TRI	-TRH		KINK	KINK	
	OUTSIDE KINK	INSIDE KINK	CRIMPED				



# APPROVAL SHEET

## DIMENSION OF TAPING PRODUCT

Symbol	PARAMETER	Model Size				
		05D series	07D series	10D series		14D series
P	Pitch of Component	12.7±1.0	12.7±1.0	12.7±1.0	15.0±1.0	25.4±1.0
P <sub>0</sub>	Feed Hole Pitch	12.7±0.2	12.7±0.2	12.7±0.2	15.0±0.2	25.4±0.2
P <sub>1</sub>	Feed Hole Center to Lead	3.85±0.7	3.85±0.7	3.85±0.7	5.00±0.7	8.95±0.7
P <sub>2</sub>	Hole Center to Component Center	6.35±0.7	6.35±0.7	6.35±0.7	7.50±1.0	12.7±0.7
F	Lead to Lead Distance	5.0±0.8	5.0±0.8	7.5±0.8	7.5±0.8	7.5±0.8
△ h	Component Alignment	2.0 Max	2.0 Max	2.0 Max	2.0 Max	2.0 Max
W	Tape Width	18.0+1.0	18.0+1.0	18.0+1.0	18.0+1.0	18.0+1.0
		18.0-0.5	18.0-0.5	18.0-0.5	18.0-0.5	18.0-0.5
W <sub>0</sub>	Hold Down Tape Width	5.0MIN.	5.0MIN.	5.0MIN.	5.0MIN.	5.0MIN.
W <sub>1</sub>	Hole Position	9.0+0.75	9.0+0.75	9.0+0.75	9.0+0.75	9.0+0.75
		9.0-0.50	9.0-0.50	9.0-0.50	9.0-0.50	9.0-0.50
W <sub>2</sub>	Hold Down Tape Position	3.0Max	3.0Max	3.0Max	3.0Max	3.0Max
H	Height from Tape Center to Component Base	18.0+2.0	18.0+2.0	18.0+2.0	18.0+2.0	18.0+2.0
		18.0-0.0	18.0-0.0	18.0-0.0	18.0-0.0	18.0-0.0
H <sub>0</sub>	Seating Plane Height	16.0±0.5	16.0±0.5	16.0±0.5	16.0±0.5	16.0±0.5
H <sub>1</sub>	Component Height	29.0Max	32.0Max	36.0Max	36.0Max	40.0Max
D <sub>0</sub>	Feed Hole Diameter	4.0±0.2	4.0±0.2	4.0±0.2	4.0±0.2	4.0±0.2
t	Total Tape Thickness	0.7±0.2	0.7±0.2	0.7±0.2	0.7±0.2	0.7±0.2
L	Length of Clipped Lead	11.0 Max	11.0 Max	11.0 Max	11.0 Max	11.0 Max

Note: Dimensions are in mm

### Packing Q'ty

Tape & Reel (TRK/TRI/TRH Type)					Flat Box (BTK/BTI/BTH TYPE)			
Model No.	Min.Q'ty(pcs) /Reel	Min.Q'ty(pcs) /Inner Box	Min. Q'ty(pcs) /Carton	Model No.	Min.Q'ty(pcs) /Reel	Min.Q'ty(pcs) /Inner Box	Min. Q'ty(pcs) /Carton	
05D	180K~391K	2000	4000	16000	180K~391K	1500	18000	1 、 2
	431K~781K	1500	3000	12000	431K~781K	1000	12000	1 、 2
07D	180K~391K	2000	4000	16000	180K~391K	1500	18000	1 、 2
	431K~821K	1500	3000	12000	431K~821K	1000	12000	1 、 2
10D	180K~271K	1500	3000	12000	X			3 、 4
	301K~112K	1000	2000	8000				3 、 4
14D	180K~391K	800	1600	6400				5 、 6
	431K~621K	700	1400	5600				5 、 6
	681K~182K	600	1200	4800				5 、 6

## Packing information

### 1. Standard

Packing Bag

unit:cm

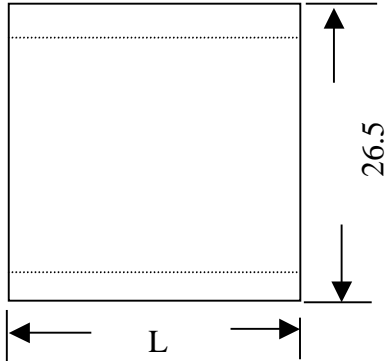

L	05D to 10D Series	10.5
	14D to 20D Series	14.5

Inner box dimension

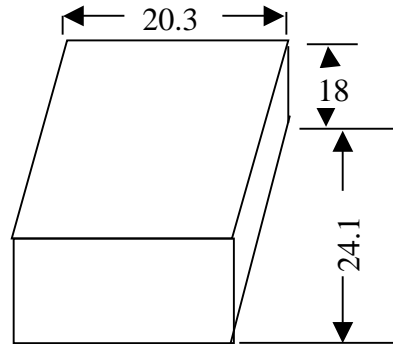

Label

Part No.		Inspected by
Quantity		
Lot No.		

Carton Dimensions (Height 21.5cm)

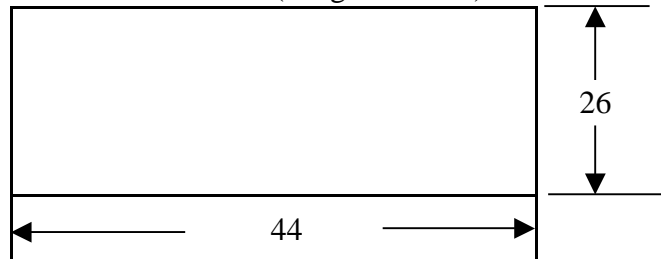

### 2. Flat box

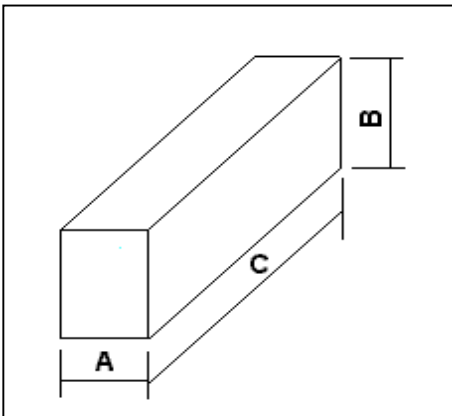

Symbol	05D	07D	10D
A	55 max		
B	330 max		
C	340 max		

### 3. Tape & Reel

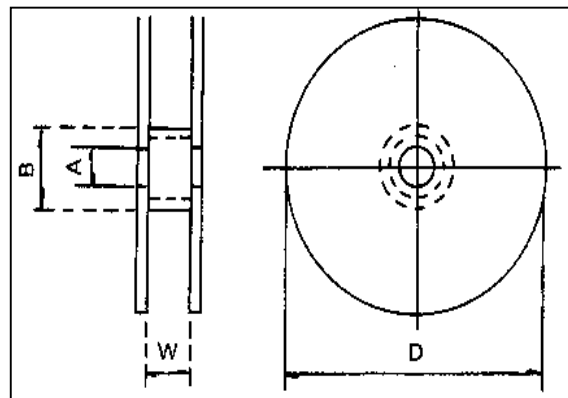

Symbol	05D	07D	10D	14D
W	45			55
D	360 max			
A	$\phi$ 30			
B	$\phi$ 90			



# APPROVAL SHEET

## Performance Characteristics (Electrical)

Characteristics	Test Methods/Description	Specifications																									
Standard Test Condition	Environmental conditions under which every measuring is done without doubt on the measuring results. Unless specially specified, temperature, relative humidity are 5 to 35 °C, 45 to 85 % RH.	—																									
Varistor Voltage	The voltage between two terminals with the specified measuring current $I_{mA}$ DC applied is called $V_c$ or $V_{cmA}$ . The measurement shall be made as fast as possible to avoid heat affection.	To meet the specified value																									
Maximum Allowable Voltage	The maximum sinusoidal RMS voltage or maximum DC voltage that can be applied continuously in the specified environmental temperature range.																										
Clamping Voltage	The maximum voltage between two terminals with the specified standard impulse current (8/20 $\mu s$ ) illustrated below applied.  <div style="text-align: center;"> </div>																										
Rated Power	The power that can be applied in the specified ambient temperature.																										
Maximum Energy	The maximum energy within the varistor voltage change of $\pm 10\%$ when one impulse of 2 ms or 10/1000 $\mu s$ is applied.																										
<div style="border: 1px solid black; padding: 5px; display: inline-block;">                     Maximum peak Current Withstanding Surge Current                 </div>	2 times	The maximum current within the varistor voltage change of $\pm 10\%$ with the standard impulse current (8/20 $\mu s$ ) applied two times with an interval of 5 minutes.																									
	1 times	The maximum current within the varistor voltage change of $\pm 10\%$ with the standard impulse current (8/20 $\mu s$ ) applied one times.																									
Temperature Coefficient of Varistor Voltage	$\frac{V_c \text{ at } 85^\circ\text{C} - V_c \text{ at } 25^\circ\text{C}}{V_c \text{ at } 25^\circ\text{C}} \times \frac{1}{60} \times 100 (\% / ^\circ\text{C})$	- 0.05 %/°C max																									
Capacitance	Capacitance shall be measured at 1 HK <sub>Z</sub> $\pm 10\%$ , 1Vrms max . 0V bias and 20 $\pm 2^\circ\text{C}$	To meet the specified value																									
Dissipation Factor	Dissipation Factor be measured at 1 HK <sub>Z</sub> $\pm 10\%$ , 1Vrms max . 0V bias and 20 $\pm 2^\circ\text{C}$	value																									
Withstanding Voltage (Body Insulation)	The specified voltage shall be applied both terminals of the specimen connected together and metal foil closely wrapped round its body for 1 minute. Electrical breakdown shall be examined.  <table border="1" style="margin-left: auto; margin-right: auto; border-collapse: collapse;"> <thead> <tr> <th style="text-align: center;">Classification (Nominal varistor voltage)</th> <th style="text-align: center;">Test Voltage (AC)</th> </tr> </thead> <tbody> <tr> <td style="text-align: center;"><math>V_{0.1mA}, V_{1mA} \leq 330V</math></td> <td style="text-align: center;">1000 Vrms</td> </tr> <tr> <td style="text-align: center;"><math>V_{0.1mA}, V_{1mA} &gt; 330V</math></td> <td style="text-align: center;">1500 Vrms</td> </tr> </tbody> </table>	Classification (Nominal varistor voltage)	Test Voltage (AC)	$V_{0.1mA}, V_{1mA} \leq 330V$	1000 Vrms	$V_{0.1mA}, V_{1mA} > 330V$	1500 Vrms	No breakdown																			
Classification (Nominal varistor voltage)	Test Voltage (AC)																										
$V_{0.1mA}, V_{1mA} \leq 330V$	1000 Vrms																										
$V_{0.1mA}, V_{1mA} > 330V$	1500 Vrms																										
Impulse Life (I)	The change of $V_c$ shall be measured after the impulse listed below is applied 10000 times continuously with the interval of ten seconds at room temperature .  <table border="1" style="margin-left: auto; margin-right: auto; border-collapse: collapse;"> <tbody> <tr> <td rowspan="2" style="text-align: center;">5 Series</td> <td style="text-align: center;">CNR-05D180K to CNR-05D680K</td> <td style="text-align: center;">0.5A (2 ms)</td> </tr> <tr> <td style="text-align: center;">CNR-05D820K to CNR-05D471K</td> <td style="text-align: center;">20A (8/20 <math>\mu s</math>)</td> </tr> <tr> <td rowspan="2" style="text-align: center;">7 Series</td> <td style="text-align: center;">CNR-07D180K to CNR-07D680K</td> <td style="text-align: center;">18A (8/20 <math>\mu s</math>)</td> </tr> <tr> <td style="text-align: center;">CNR-07D820K to CNR-07D471K</td> <td style="text-align: center;">50A (8/20 <math>\mu s</math>)</td> </tr> <tr> <td rowspan="2" style="text-align: center;">10 Series</td> <td style="text-align: center;">CNR-10D180K to CNR-10D680K</td> <td style="text-align: center;">50A (8/20 <math>\mu s</math>)</td> </tr> <tr> <td style="text-align: center;">CNR-10D820K to CNR-10D112K</td> <td style="text-align: center;">100A (8/20 <math>\mu s</math>)</td> </tr> <tr> <td rowspan="2" style="text-align: center;">14 Series</td> <td style="text-align: center;">CNR-14D180K to CNR-14D680K</td> <td style="text-align: center;">75A (8/20 <math>\mu s</math>)</td> </tr> <tr> <td style="text-align: center;">CNR-14D820K to CNR-14D182K</td> <td style="text-align: center;">150A (8/20 <math>\mu s</math>)</td> </tr> <tr> <td rowspan="2" style="text-align: center;">20 Series</td> <td style="text-align: center;">CNR-20D180K to CNR-20D680K</td> <td style="text-align: center;">120A (8/20 <math>\mu s</math>)</td> </tr> <tr> <td style="text-align: center;">CNR-20D820K to CNR-20D182K</td> <td style="text-align: center;">200A (8/20 <math>\mu s</math>)</td> </tr> </tbody> </table>	5 Series	CNR-05D180K to CNR-05D680K	0.5A (2 ms)	CNR-05D820K to CNR-05D471K	20A (8/20 $\mu s$ )	7 Series	CNR-07D180K to CNR-07D680K	18A (8/20 $\mu s$ )	CNR-07D820K to CNR-07D471K	50A (8/20 $\mu s$ )	10 Series	CNR-10D180K to CNR-10D680K	50A (8/20 $\mu s$ )	CNR-10D820K to CNR-10D112K	100A (8/20 $\mu s$ )	14 Series	CNR-14D180K to CNR-14D680K	75A (8/20 $\mu s$ )	CNR-14D820K to CNR-14D182K	150A (8/20 $\mu s$ )	20 Series	CNR-20D180K to CNR-20D680K	120A (8/20 $\mu s$ )	CNR-20D820K to CNR-20D182K	200A (8/20 $\mu s$ )	$\Delta V_{cmA} / V_{cmA} \leq \pm 10\%$
5 Series	CNR-05D180K to CNR-05D680K		0.5A (2 ms)																								
	CNR-05D820K to CNR-05D471K	20A (8/20 $\mu s$ )																									
7 Series	CNR-07D180K to CNR-07D680K	18A (8/20 $\mu s$ )																									
	CNR-07D820K to CNR-07D471K	50A (8/20 $\mu s$ )																									
10 Series	CNR-10D180K to CNR-10D680K	50A (8/20 $\mu s$ )																									
	CNR-10D820K to CNR-10D112K	100A (8/20 $\mu s$ )																									
14 Series	CNR-14D180K to CNR-14D680K	75A (8/20 $\mu s$ )																									
	CNR-14D820K to CNR-14D182K	150A (8/20 $\mu s$ )																									
20 Series	CNR-20D180K to CNR-20D680K	120A (8/20 $\mu s$ )																									
	CNR-20D820K to CNR-20D182K	200A (8/20 $\mu s$ )																									

Note: Varistor voltage change of forward direction shall be measured in the test of uni-pole surge life and DC load life



# APPROVAL SHEET

(Electrical)

Characteristics	Test Methods		Specifications	
Impulse Life (II)	The change of Vc shall be measured after the impulse listed below is applied 100000 times continuously with the interval of ten seconds at room temperature .		$\Delta V_{cmA}/V_{cmA} \leq \pm 10\%$	
	5 Series	CNR-05D180K to CNR-05D680K		0.45A (2 ms)
		CNR-05D820K to CNR-05D471K		14A (8/20 $\mu$ s)
	7 Series	CNR-07D180K to CNR-07D680K		12A (8/20 $\mu$ s)
		CNR-07D820K to CNR-07D471K		35A (8/20 $\mu$ s)
	10 Series	CNR-10D180K to CNR-10D680K		35A (8/20 $\mu$ s)
		CNR-10D820K to CNR-10D471K		70A (8/20 $\mu$ s)
	14 Series	CNR-14D180K to CNR-14D680K		45A (8/20 $\mu$ s)
		CNR-14D820K to CNR-14D471K		90A (8/20 $\mu$ s)
	20 Series	CNR-20D180K to CNR-20D680K		55A (8/20 $\mu$ s)
CNR-20D820K to CNR-20D471K		100A (8/20 $\mu$ s)		

Note: Varistor voltage change of forward direction shall be measured in the test of uni-pole surge life and DC load life

(Mechanical)

Characteristics	Test Methods		Specifications	
Robustness of Terminations (Tenaile)	After gradually applying the force specified below and keeping the unit fixed for the seconds, the terminal shall be visually examined for any damage.			
		Terminal diameter		Force
		$\varnothing$ 0.6 mm		9.8 N (1.0Kgf)
		$\varnothing$ 0.8 mm		9.8 N (1.0Kgf)
Robustness of Terminations (Bending)	The unit shall be secured with its terminal kept vertical and the force specified below be applied in the axial direction.		No outstanding damage	
	The terminal shall gradually be bent by 90° in one direction, then 90° in the opposite direction, and again back to the original position.			
	The damage of the terminal shall be visually examined.			
		Terminal diameter		Force
	$\varnothing$ 0.6 mm	4.9 N (0.5Kgf)		
	$\varnothing$ 0.8 mm	4.9 N (0.5Kgf)		
	$\varnothing$ 1.0 mm	9.8 N (1.0Kgf)		
Vibration	After repeatedly applying a single harmonic vibration (amplitude: 0.75 mm) double amplitude: 1.5mm with 1 minute vibration frequency cycles (10 Hz to 55 Hz to 10 Hz) to each of three perpendicular directions for 2 hours. Thereafter, the unit shall be visually examined			
Solderability	After dipping the terminals to a depth of approximately 3mm from the body in a soldering bath of 235±5°C for 2±0.5 seconds, the terminal shall be visually examined.		Approximately 95% of the terminals shall be covered with solder uni-formly	
Resistance to Soldering Heat	After each lead shall be dipped into a solder bath having a temperature 260 ±5°C (3 series: 250±5°C) to a point 2.0 to 2.5 mm from the body of the unit, using shieldig board (t=1.5mm), be held there for specified time (3 series: 3±1 s, 5 series: 5±1 s and others: 10±1 s), and then be stored at room temperature and humidity for 1 to 2 hours. The change of Vc and mechanical damages are examind.		$\Delta V_{cmA}/V_{cmA} \leq \pm 5\%$ No outstanding damage	



# APPROVAL SHEET

(Environmental)

Characteristics	Test Methods	Specifications															
High Temperature Storage/ Dry Heat	The specimen shall be subjected to $125 \pm 2$ °C for 1000 hours in a thermostatic bath without load and then stored at room temperature and humidity for 1 to 2 hours. Thereafter, the change of Vc shall be measured.																
Damp Heat/ Humidity (Steady State)	The specimen shall be subjected to $40 \pm 2$ °C, 90 to 95 %RH for 1000 hours without load and then stored at room temperature and humidity for one to two hours. Thereafter, the change of Vc shall be measured.																
Temperature Cycle	<p>The temperature cycle shown below shall be repeated five times and then stored at room temperature and humidity for one to two hours. The change of Vc and mechanical damage shall be examined.</p> <table border="1"> <thead> <tr> <th>Step</th> <th>Temperature(°C)</th> <th>Period (minutes)</th> </tr> </thead> <tbody> <tr> <td>1</td> <td><math>-40 \pm 3</math></td> <td><math>30 \pm 3</math></td> </tr> <tr> <td>2</td> <td>Room temperature</td> <td><math>15 \pm 3</math></td> </tr> <tr> <td>3</td> <td><math>125 \pm 2</math></td> <td><math>30 \pm 3</math></td> </tr> <tr> <td>4</td> <td>Room temperature</td> <td><math>15 \pm 3</math></td> </tr> </tbody> </table>	Step	Temperature(°C)	Period (minutes)	1	$-40 \pm 3$	$30 \pm 3$	2	Room temperature	$15 \pm 3$	3	$125 \pm 2$	$30 \pm 3$	4	Room temperature	$15 \pm 3$	$\Delta V_{cmA}/V_{cmA} \leq \pm 5\%$
Step	Temperature(°C)	Period (minutes)															
1	$-40 \pm 3$	$30 \pm 3$															
2	Room temperature	$15 \pm 3$															
3	$125 \pm 2$	$30 \pm 3$															
4	Room temperature	$15 \pm 3$															
High Temperature Load/ Dry Heat Load	After being continuously applied the Maximum Allowable Voltage at $85 \pm 2$ °C for 1000 hours. The specimen shall be stored at room temperature and humidity for one to two hours. Thereafter, the change of Vc shall be measured.	$\Delta V_{cmA}/V_{cmA} \leq \pm 10\%$															
Damp Heat Load/ Humidity Load	The specimen shall be subjected to $40 \pm 2$ °C, 90 to 95 %RH and the Maximum Allowable Voltage for 1000 hours and then stored at room temperature and humidity for one to two hours. Thereafter, the change of Vc shall be measured.	$\Delta V_{cmA}/V_{cmA} \leq \pm 10\%$															
Low Temperature Storage/Cold	The specimen shall be subjected to $-40 \pm 2$ °C without load for 1000 hours and then stored at room temperature for one to two hours. Thereafter, the change of Vc shall be measured.	$\Delta V_{cmA}/V_{cmA} \leq \pm 5\%$															