



SGM8552

Single-Supply, Dual Rail-to-Rail I/O Precision Operational Amplifier

PRODUCT DESCRIPTION

The SGM8552 is a dual rail-to-rail input and output precision operational amplifier which has low input offset voltage, and bias current. It is guaranteed to operate from 2.5V to 5.5V single supply.

The rail-to-rail input and output swings provided by the SGM8552 make both high-side and low-side sensing easy. The combination of characteristics makes the SGM8552 good choices for temperature, position and pressure sensors, medical equipment and strain gauge amplifiers, or any other 2.5V to 5.5V application requiring precision and long term stability.

The SGM8552 is specified for the extended industrial/automotive (-40°C to +125°C) temperature range. It is available in the Green SOIC-8 and MSOP-8 packages and ESD (HBM) reaches 8KV.

APPLICATIONS

- Temperature Measurements
- Pressure Sensors
- Precision Current Sensing
- Electronic Scales
- Strain Gauge Amplifiers
- Medical Instrumentation
- Thermocouple Amplifiers
- Handheld Test Equipment

FEATURES

- **Low Offset Voltage:** 4 μ V (TYP)
- **Rail-to-Rail Input and Output Swing**
- **2.5V to 5.5V Single Supply Operation**
- **Voltage Gain:** 145dB (TYP) at +5V
- **PSRR:** 110dB (TYP)
- **CMRR:** 105dB (TYP)
- **Ultra Low Input Bias Current:** 10pA
- **Low Supply Current:** 930 μ A (TYP)
- **Overload Recovery Time:** 60 μ s (at $V_s = +5V$)
- **No External Capacitors Required**
- **-40°C to +125°C Operating Temperature Range**
- **Available in Green SOIC-8 and MSOP-8 Packages**

PIN CONFIGURATIONS (TOP VIEW)

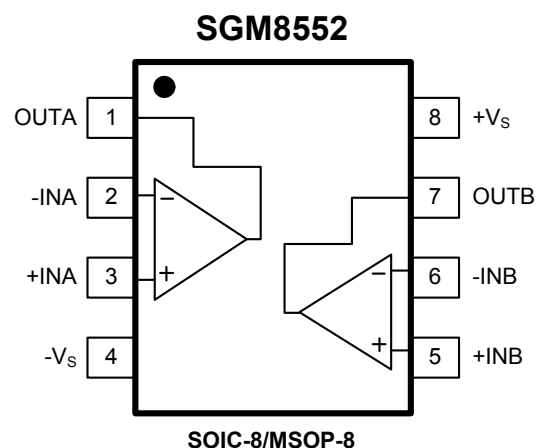

PACKAGE/ORDERING INFORMATION

MODEL	ORDER NUMBER	PACKAGE DESCRIPTION	PACKAGE OPTION	MARKING INFORMATION
SGM8552	SGM8552XMS8G/TR	MSOP-8	Tape and Reel, 3000	SGM8552XMS8
	SGM8552XS8G/TR	SOIC-8	Tape and Reel, 2500	SGM8552XS8

ABSOLUTE MAXIMUM RATINGS

Supply Voltage	.6V
Input Voltage	-V _S to (+V _S) + 0.1V
Differential Input Voltage	-5V to 5V
Storage Temperature Range	-65°C to +150°C
Junction Temperature	150°C
Operating Temperature Range	-40°C to +125°C
Lead Temperature (Soldering 10 sec)	260°C
ESD Susceptibility	
HBM	8000V
MM	400V

NOTE:

Stresses beyond those listed under “Absolute Maximum Ratings” may cause permanent damage to the device. These are stress ratings only, and functional operation of the device at these or any other conditions beyond those indicated in the operational sections of the specifications is not implied. Exposure to absolute maximum rating conditions for extended periods may affect device reliability.

CAUTION

This integrated circuit can be damaged by ESD if you don't pay attention to ESD protection. SGMICRO recommends that all integrated circuits be handled with appropriate precautions. Failure to observe proper handling and installation procedures can cause damage. ESD damage can range from subtle performance degradation to complete device failure. Precision integrated circuits may be more susceptible to damage because very small parametric changes could cause the device not to meet its published specifications.

SGMICRO reserves the right to make any change in circuit design, specification or other related things if necessary without notice at any time. Please contact SGMICRO sales office to get the latest datasheet.

ELECTRICAL CHARACTERISTICS(V_S = +5V, V_{CM} = +2.5V, V_O = +2.5V, T_A = +25°C, unless otherwise noted.)

PARAMETER	CONDITIONS	MIN	TYP	MAX	UNITS
INPUT CHARACTERISTICS					
Input Offset Voltage (V _{OS})			4	20	μV
	-40°C ≤ T _A ≤ +125°C			24	
Input Bias Current (I _B)			10		pA
Input Offset Current (I _{OS})			5		pA
Input Voltage Range		0		5	V
Common Mode Rejection Ratio ⁽¹⁾ (CMRR)	V _{CM} = 0V to 5V	90	105		dB
	-40°C ≤ T _A ≤ +125°C	83			
Large Signal Voltage Gain (A _{VO})	R _L = 10kΩ, V _O = 0.3V to 4.7V	100	145		dB
	-40°C ≤ T _A ≤ +125°C	97			
Input Offset Voltage Drift (ΔV _{OS} /ΔT)	-40°C ≤ T _A ≤ +125°C		20		nV/°C
OUTPUT CHARACTERISTICS					
Output Voltage High (V _{OH})	R _L = 100kΩ to -V _S	4.99	4.998		V
	-40°C ≤ T _A ≤ +125°C	4.987			
	R _L = 10kΩ to -V _S	4.985	4.996		V
	-40°C ≤ T _A ≤ +125°C	4.98			
Output Voltage Low (V _{OL})	R _L = 100kΩ to +V _S		2	10	mV
	-40°C ≤ T _A ≤ +125°C			13	
	R _L = 10kΩ to +V _S		6	15	mV
	-40°C ≤ T _A ≤ +125°C			20	
Short Circuit Limit (I _{SC})	V _O = 2.5V, R _L = 10Ω to GND	40	48		mA
	-40°C ≤ T _A ≤ +125°C	23			
POWER SUPPLY					
Power Supply Rejection Ratio ⁽¹⁾ (PSRR)	V _S = 2.5V to 5.5V	90	110		dB
	-40°C ≤ T _A ≤ +125°C	80			
Quiescent Current (I _O)	V _O = +V _S /2		930	1110	μA
	-40°C ≤ T _A ≤ +125°C			1760	
DYNAMIC PERFORMANCE					
Gain-Bandwidth Product (GBP)	A _V = +100		1.53		MHz
Slew Rate (SR)	A _V = +1, R _L = 10kΩ, 2V Output Step		0.90		V/μs
Overload Recovery Time	A _V = -100, R _L = 10kΩ, V _{IN} = 200mV (RET to GND)		0.06		ms
NOISE PERFORMANCE					
Voltage Noise (e _n p-p)	0.1Hz to 10Hz		0.80		μV _{P-P}
Voltage Noise Density (e _n)	f = 1kHz		47.5		nV/√Hz

NOTE 1: PSRR and CMRR are affected by the matching between external gain-setting resistor ratios.

ELECTRICAL CHARACTERISTICS(V_S = +2.5V, V_{CM} = +1.25V, V_O = +1.25V, T_A = +25°C, unless otherwise noted.)

PARAMETER	CONDITIONS	MIN	TYP	MAX	UNITS
INPUT CHARACTERISTICS					
Input Offset Voltage (V _{OS})			3	20	μV
	-40°C ≤ T _A ≤ +125°C			24	
Input Bias Current (I _B)			10		pA
Input Offset Current (I _{OS})			10		pA
Input Voltage Range		0		2.5	V
Common Mode Rejection Ratio ⁽¹⁾ (CMRR)	V _{CM} = 0V to 2.5V	90	105		dB
	-40°C ≤ T _A ≤ +125°C	81			
Large Signal Voltage Gain (A _{VO})	R _L = 10kΩ, V _O = 0.3V to 2.4V	100	135		dB
	-40°C ≤ T _A ≤ +125°C	94			
Input Offset Voltage Drift (ΔV _{OS} /ΔT)	-40°C ≤ T _A ≤ +125°C		20		nV/°C
OUTPUT CHARACTERISTICS					
Output Voltage High (V _{OH})	R _L = 100kΩ to -V _S	2.49	2.499		V
	-40°C ≤ T _A ≤ +125°C	2.488			
	R _L = 10kΩ to -V _S	2.485	2.498		V
	-40°C ≤ T _A ≤ +125°C	2.482			
Output Voltage Low (V _{OL})	R _L = 100kΩ to +V _S		1	10	mV
	-40°C ≤ T _A ≤ +125°C			12	
	R _L = 10kΩ to +V _S		3	15	mV
	-40°C ≤ T _A ≤ +125°C			18	
Short Circuit Limit (I _{SC})	V _O = 1.25V, R _L = 10Ω to GND	20	28		mA
	-40°C ≤ T _A ≤ +125°C	15			
POWER SUPPLY					
Power Supply Rejection Ratio ⁽¹⁾ (PSRR)	V _S = 2.5V to 5.5V	90	110		dB
	-40°C ≤ T _A ≤ +125°C	80			
Quiescent Current (I _O)	V _O = +V _S /2		1000	1110	μA
	-40°C ≤ T _A ≤ +125°C			2090	
DYNAMIC PERFORMANCE					
Gain-Bandwidth Product (GBP)	A _V = +100		1.51		MHz
Slew Rate (SR)	A _V = +1, R _L = 10kΩ, 2V Output Step		0.90		V/μs
Overload Recovery Time	A _V = -100, R _L = 10kΩ, V _{IN} = 200mV (RET to GND)		0.03		ms
NOISE PERFORMANCE					
Voltage Noise (e _{n p-p})	0.1Hz to 10Hz		0.95		μV _{p-p}
Voltage Noise Density (e _n)	f = 1kHz		53		nV/√Hz

NOTE 1: PSRR and CMRR are affected by the matching between external gain-setting resistor ratios.

TYPICAL PERFORMANCE CHARACTERISTICS

Large Signal Transient Response at +5V

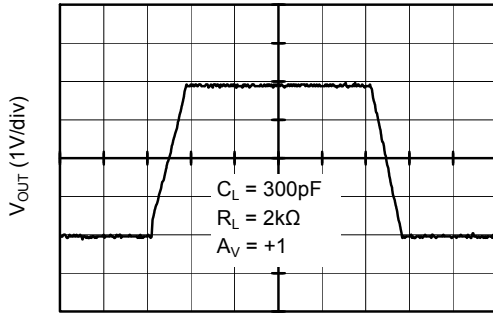

Time (5µs/div)

Large Signal Transient Response at +2.5V

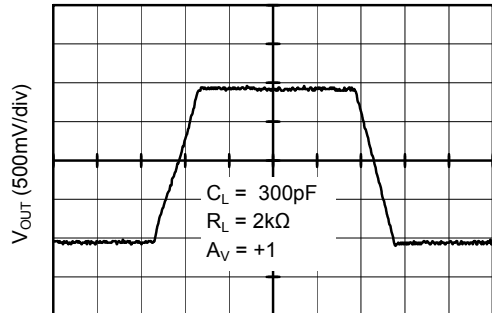

Time (2µs/div)

Small Signal Transient Response at +5V

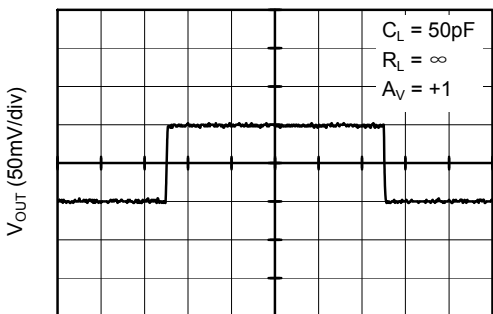

Time (5µs/div)

Small Signal Transient Response at +2.5V

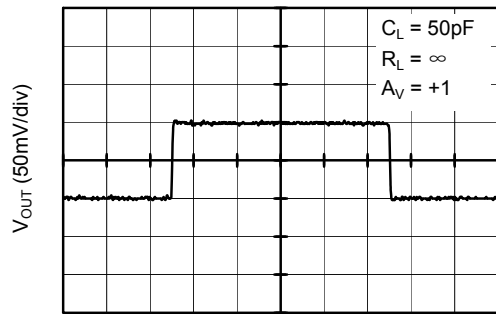

Time (5µs/div)

Closed Loop Gain vs. Frequency at +5V

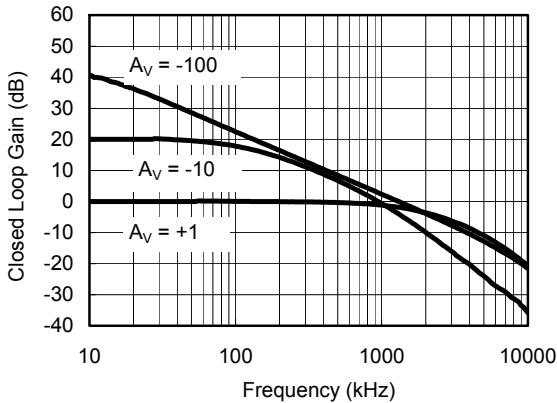

Closed Loop Gain vs. Frequency at +2.5V

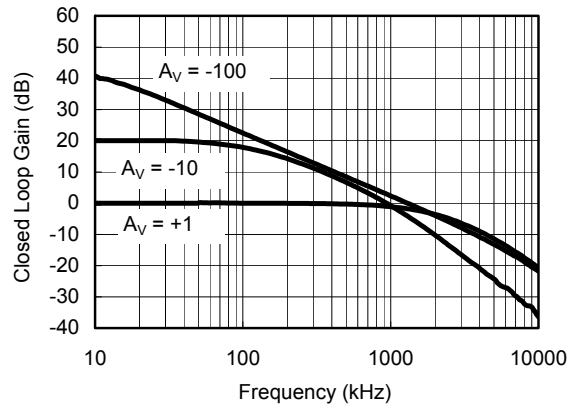

TYPICAL PERFORMANCE CHARACTERISTICS

Positive Overvoltage Recovery

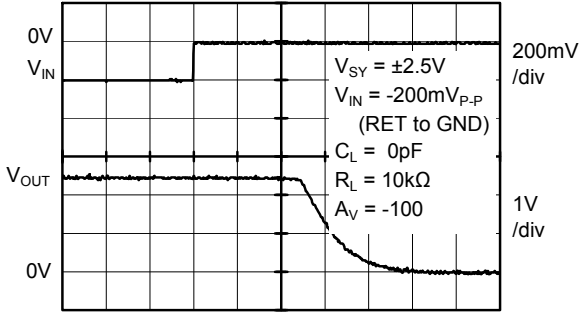

Time (20µs/div)

Negative Overvoltage Recovery

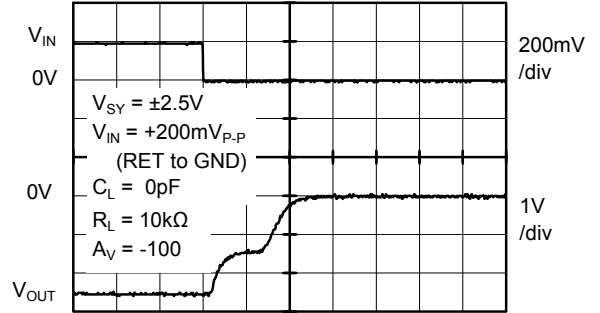

Time (50µs/div)

Open Loop Gain, Phase Shift vs. Frequency at +5V

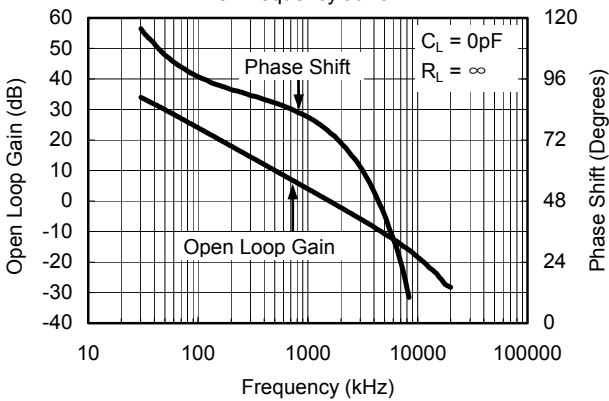

Open Loop Gain, Phase Shift vs. Frequency at +2.5V

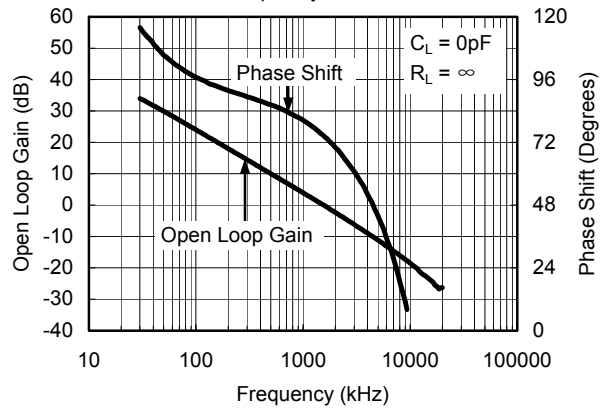

0.1Hz to 10Hz Noise at +5V

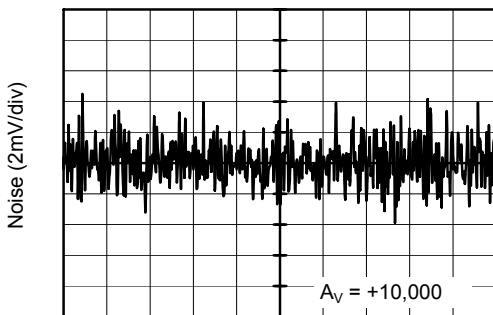

Time (10s/div)

0.1Hz to 10Hz Noise at +2.5V

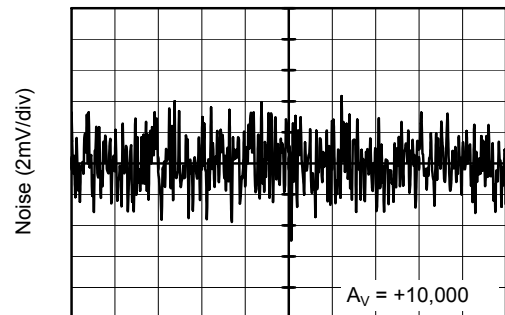

Time (10s/div)

TYPICAL PERFORMANCE CHARACTERISTICS

Voltage Noise Density at +5V from 0.1Hz to 2.5kHz

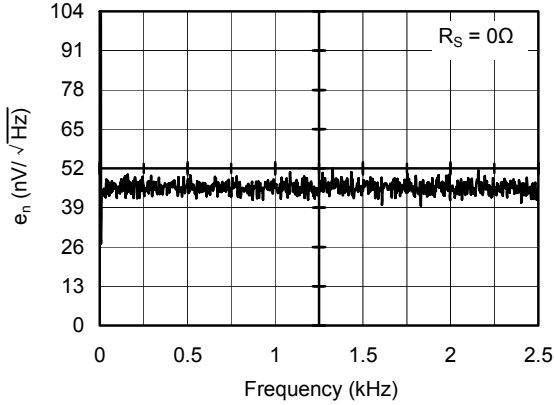

Voltage Noise Density at +2.5V from 0.1Hz to 2.5kHz

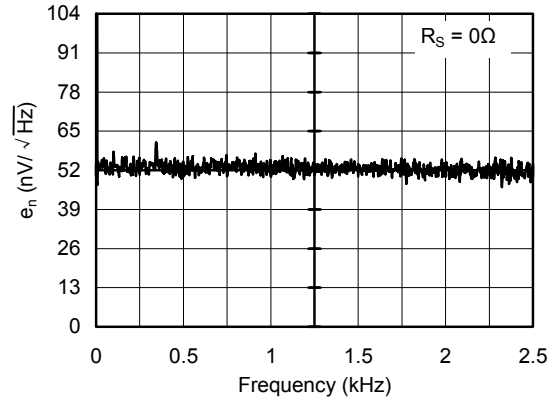

Voltage Noise Density at +5V from 0.1Hz to 25kHz

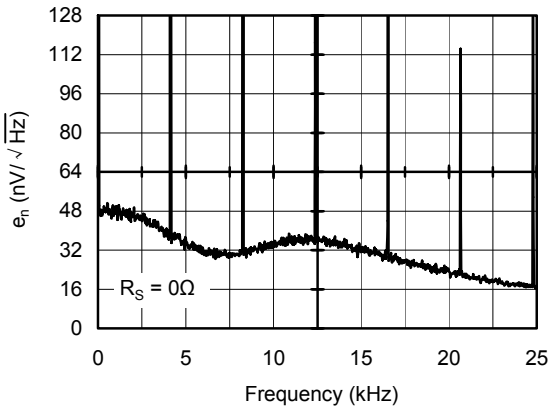

Voltage Noise Density at +2.5V from 0.1Hz to 25kHz

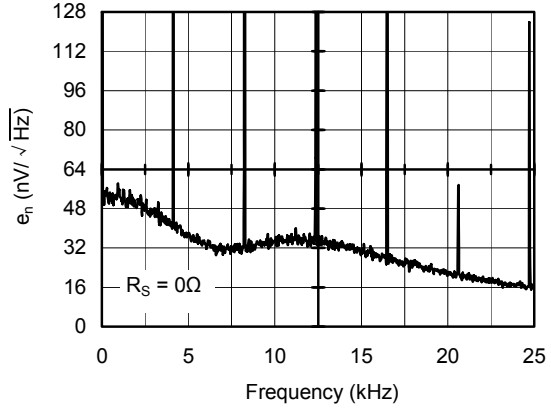

PSRR vs. Frequency at ±2.5V

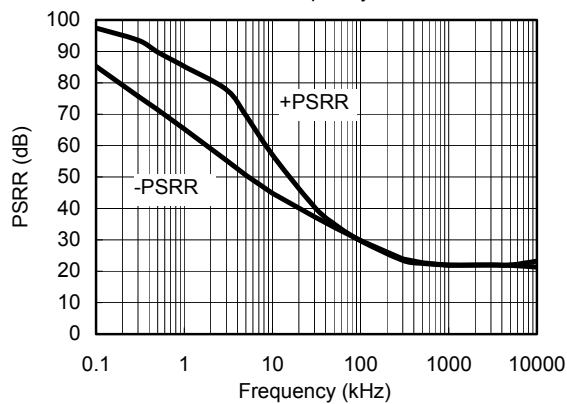

PSRR vs. Frequency at ±1.25V

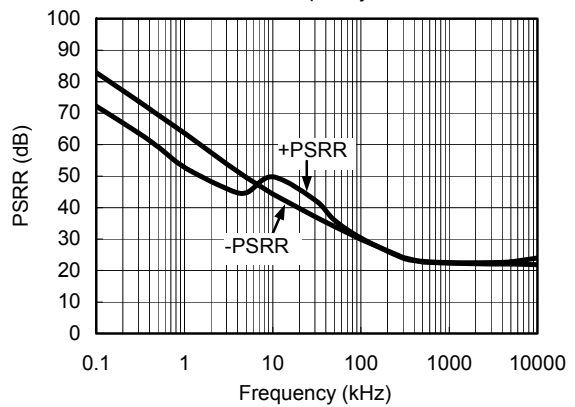

TYPICAL PERFORMANCE CHARACTERISTICS

CMRR vs. Frequency at +5V

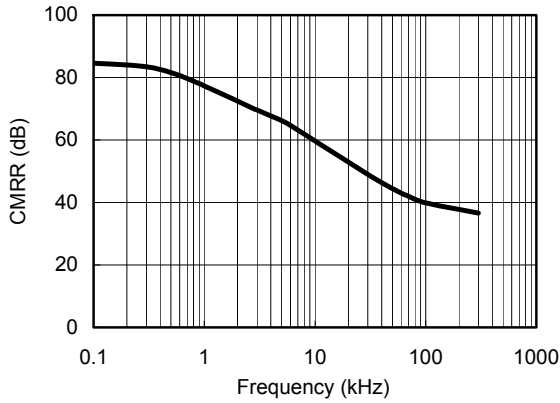

CMRR vs. Frequency at +2.5V

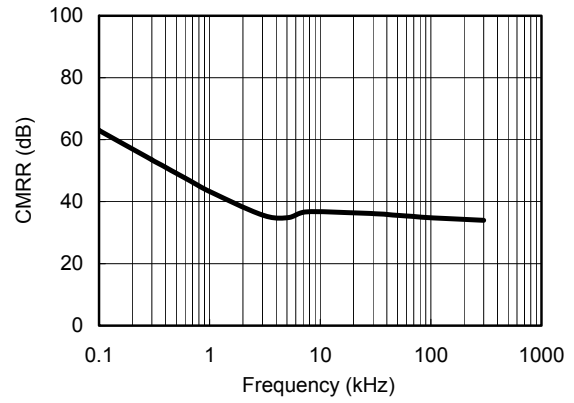

Offset Voltage Production Distribution at +5V

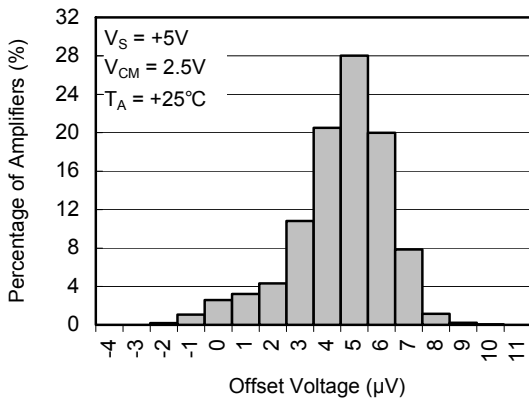

Offset Voltage Production Distribution at +2.5V

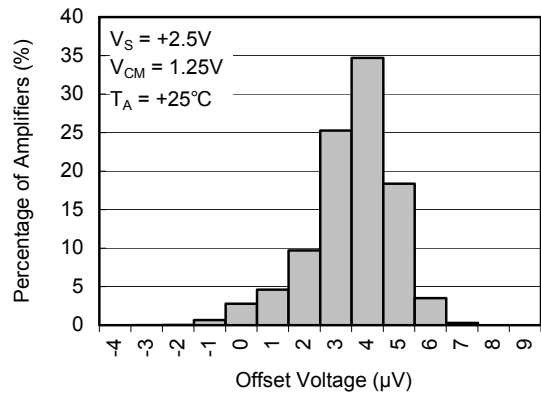

PACKAGE OUTLINE DIMENSIONS

MSOP-8

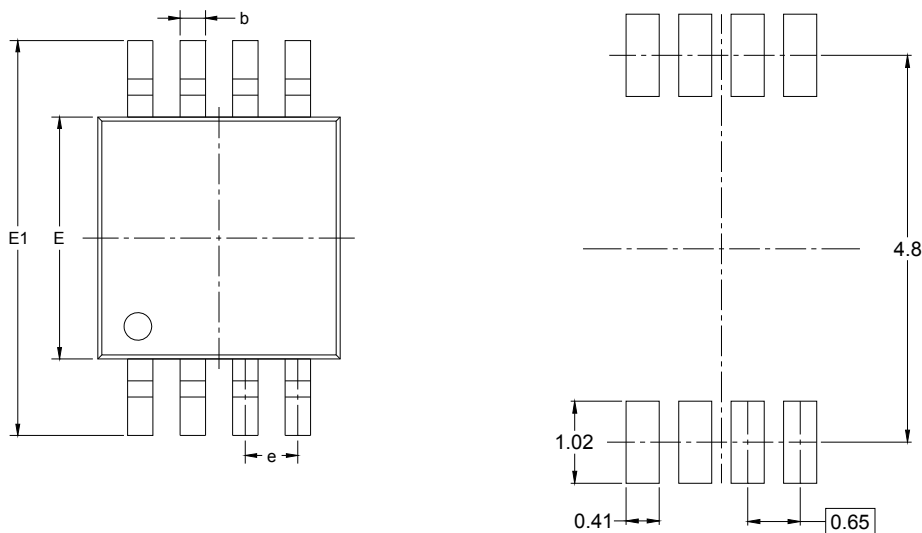

RECOMMENDED LAND PATTERN (Unit: mm)

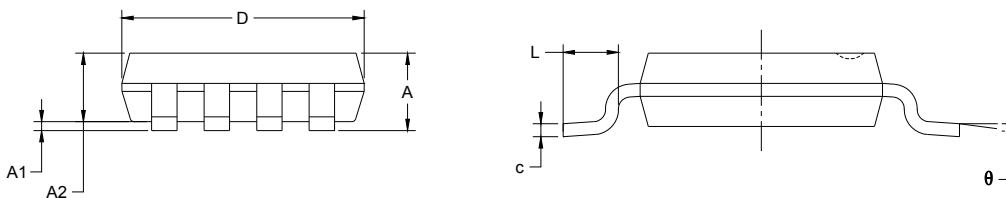

Symbol	Dimensions In Millimeters		Dimensions In Inches	
	MIN	MAX	MIN	MAX
A	0.820	1.100	0.032	0.043
A1	0.020	0.150	0.001	0.006
A2	0.750	0.950	0.030	0.037
b	0.250	0.380	0.010	0.015
c	0.090	0.230	0.004	0.009
D	2.900	3.100	0.114	0.122
E	2.900	3.100	0.114	0.122
E1	4.750	5.050	0.187	0.199
e	0.650 BSC		0.026 BSC	
L	0.400	0.800	0.016	0.031
θ	0°	6°	0°	6°

PACKAGE OUTLINE DIMENSIONS

SOIC-8

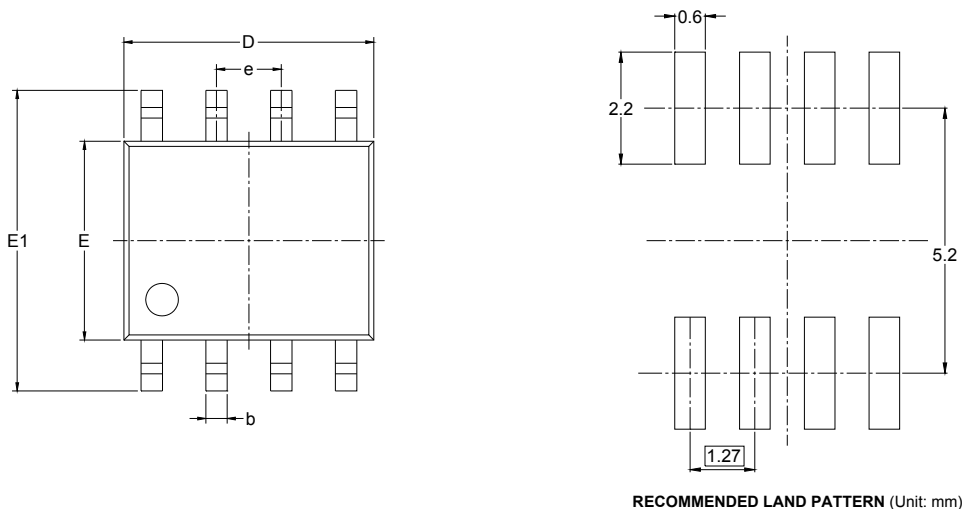

Symbol	Dimensions In Millimeters		Dimensions In Inches	
	MIN	MAX	MIN	MAX
A	1.350	1.750	0.053	0.069
A1	0.100	0.250	0.004	0.010
A2	1.350	1.550	0.053	0.061
b	0.330	0.510	0.013	0.020
c	0.170	0.250	0.006	0.010
D	4.700	5.100	0.185	0.200
E	3.800	4.000	0.150	0.157
E1	5.800	6.200	0.228	0.244
e	1.27 BSC		0.050 BSC	
L	0.400	1.270	0.016	0.050
θ	0°	8°	0°	8°

TAPE AND REEL INFORMATION

REEL DIMENSIONS

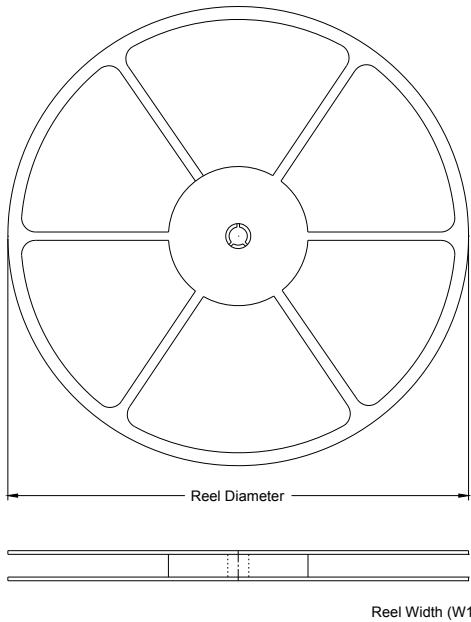

TAPE DIMENSIONS

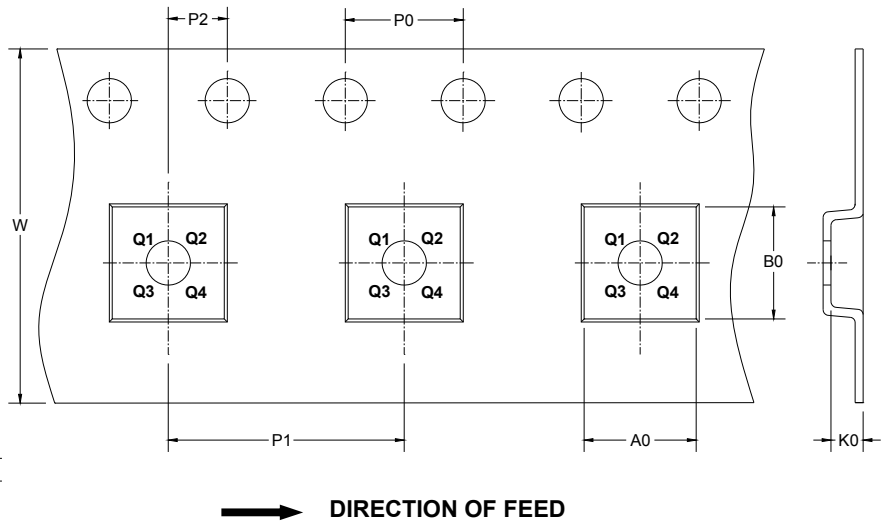

NOTE: The picture is only for reference. Please make the object as the standard.

KEY PARAMETER LIST OF TAPE AND REEL

Package Type	Reel Diameter	Reel Width W1 (mm)	A0 (mm)	B0 (mm)	K0 (mm)	P0 (mm)	P1 (mm)	P2 (mm)	W (mm)	Pin1 Quadrant
SOIC-8	13"	12.4	6.4	5.4	2.1	4.0	8.0	2.0	12.0	Q1
MSOP-8	13"	12.4	5.2	3.3	1.5	4.0	8.0	2.0	12.0	Q1

SGM8552

Single-Supply, Dual Rail-to-Rail I/O Precision Operational Amplifier

CARTON BOX DIMENSIONS

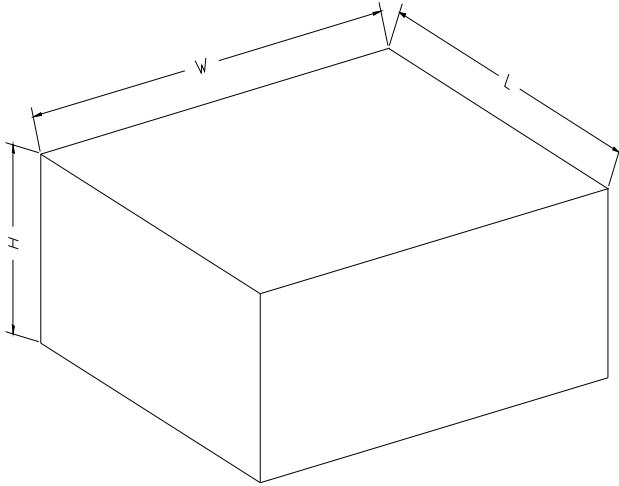

NOTE: The picture is only for reference. Please make the object as the standard.

KEY PARAMETER LIST OF CARTON BOX

Reel Type	Length (mm)	Width (mm)	Height (mm)	Pizza/Carton
13"	386	280	370	5