

30W, Ultra wide input isolated & regulated dual / single output DC/DC converter

FEATURES

- Wide range of input voltage (4:1)
- Efficiency up to 90%
- No-load power consumption as low as 0.14W
- Isolation voltage : 1500VDC
- Input under-voltage protection, output short circuit protection, over-voltage protection, Over-current protection
- Operating temperature range: -40°C to +75°C
- Meet CISPR22/EN55022 CLASS A
- Six-sided metal shielding package
- A2S (wring mounting) and A4S (35mm rail mounting) products featuring anti-reverse connection for input
- IEC60950, UL60950, EN60950 Approval



cULus CB CE Patent Protection RoHS

URB\_LD-30WR3 series are isolated 30W DC-DC products with 4:1 input voltage. They feature efficiency up to 90%, 1500VDC isolation, operating temperature of -40 °C ~+75 °C , Input under-voltage protection, output short circuit protection, over-voltage protection, over-current protection and EMI meets CISPR22/EN55022 CLASS A, which make them widely applied in data transmission device, battery power supply device, tele-communication device, distributed power supply system, remote control system, industrial robot fields. And extension package A2S and A4S also enable them with reverse voltage protection.

Selection Guide

Certification	Part No. ①	Input Voltage (VDC)		Output		Efficiency ③ (%,Min./Typ.) @ Full Load	Max. Capacitive Load(μF)
		Nominal (Range)	Max. ②	Output Voltage (VDC)	Output Current (mA)(Max./Min.)		
UL/CE/CB	URB2403LD-30WR3	24 (9-36)	40	3.3	6000/0	83/85	10000
	URB2405LD-30WR3			5	6000/0	86/88	10000
	URB2409LD-30WR3			9	3333/0	86/88	4700
	URB2412LD-30WR3			12	2500/0	88/90	2700
	URB2415LD-30WR3			15	2000/0	88/90	1680
	URB2424LD-30WR3			24	1250/0	88/90	680
	URB4803LD-30WR3	48 (18-75)	80	3.3	6000/0	85/87	10000
	URB4805LD-30WR3			5	6000/0	86/88	10000
	URB4812LD-30WR3			12	2500/0	87/89	2700
	URB4815LD-30WR3			15	2000/0	87/89	1680
URB4824LD-30WR3	24	1250/0	87/89	680			

Notes: ①Series with suffix "H" are heat sink mounting; series with suffix "A2S" are chassis mounting, with suffix "A4S" are DIN-Rail mounting, for example URB2405LD-30WRH3A2S is chassis mounting of with heat sink,URB2405LD-30WR3A4S is DIN-Rail mounting of without heat sink; If the application has a higher requirement for heat dissipation, you can choose modules with heat sink;  
②Absolute maximum rating without damage on the converter, but it isn't recommended;  
③Efficiency is measured in nominal input voltage and rated output load;A2S (wiring) and A4S (rail) Model due to input reverse polarity protection, minimum efficiency greater than Min.-2 is qualified.

Input Specifications

Item	Operating Conditions		Min.	Typ.	Max.	Unit
Input Current (full load / no-load)	24VDC input	3.3V output	--	970/60	993/80	mA
		5V output	--	1420/60	1453/80	
		Others	--	1388/6	1420/9	
	48VDC input	3.3V output	--	474/20	485/23	
		5V output	--	710/20	726/25	
		Others	--	702/5	718/8	

Reflected Ripple Current		--	40	--	mA
Input impulse Voltage (1sec. max.)	24VDC input	-0.7	--	50	VDC
	48VDC input	-0.7	--	100	
Starting Voltage	24VDC input	--	--	9	
	48VDC input	--	--	18	
Output Short circuit Protection	24VDC input	5.5	6.5	--	
	48VDC input	14.0	15.5	--	
Starting Time	Nominal input & constant resistance load	--	10	--	ms
Input Filter		Pi filter			
Hot Plug		Unavailable			
Ctrl*	Module switch on	Ctrl suspended or connected to TTL high level (3.5-12VDC)			
	Module switch off	Ctrl pin connected to GND or low level (0-1.2VDC)			
	Input current when switched off	--	5	8	mA

Note: \*The voltage of Ctrl pin is relative to input pin GND.

### Output Specifications

Item	Operating Conditions		Min.	Typ.	Max.	Unit
Positive Output Voltage Accuracy			--	±1	±3	%
Line Regulation	Full load, the input voltage is from low voltage to high voltage		--	±0.2	±0.5	
Load Regulation	0% to 100% load		--	±0.5	±1	
Transient Recovery Time			--	300	500	μs
Transient Response Deviation	25% load step change	3.3V/5V output	--	±5	±8	%
		Others	--	±3	±5	
Temperature Drift Coefficient	Full load		--	--	±0.03	%/°C
Ripple & Noise	20MHz bandwidth,5%-100% load		--	50	100	mV p-p
Trim			--	±10	--	%Vo
Over-voltage Protection			110	--	160	
Over-current Protection	Input voltage range		110	--	190	
Short circuit Protection			Hiccup, Continuous, self-recovery			

Note: \*Ripple and noise are measured by "parallel cable" method, please see DC-DC Converter Application Notes for specific operation.  
0%-5% load ripple&Noise is no more than 5%Vo.

### General Specifications

Item	Operating Conditions	Min.	Typ.	Max.	Unit
Insulation Voltage	Input-output, with the test time of 1 minute and the leak current lower than 1mA	1500	--	--	VDC
Insulation Resistance	Input-output, insulation voltage 500VDC	1000	--	--	MΩ
Isolation Capacitance	Input-output, 100KHz/0.1V	--	2000	--	pF
Operating Temperature	see Fig. 1	-40	--	+75	°C
Storage Temperature		-55	--	+125	
Storage Humidity	Non-condensing	+5	--	+95	%RH
Pin Welding Resistance Temperature	Welding spot is 1.5mm away from the casing, 10 seconds	--	--	+300	°C
Vibration		10-55Hz, 10G, 30 Min. along X, Y and Z			
Switching Frequency *	PWM mode	--	300	--	KHz
MTBF	MIL-HDBK-217F@25°C	1000	--	--	K hours

Note:\* This series of products using reduced frequency technology, the switching frequency is test value of full load,When the load is reduced to below 50%, the switching frequency decreases with decreasing load.

Physical Specifications

Casing Material		Aluminum alloy
Package Dimensions	Horizontal package( without heat sink)	50.80*25.40*11.80 mm
	Horizontal package( with heat sink)	50.80*25.40*16.30 mm
Package Dimensions	A2S wiring package ( without heat sink)	76.00*31.50*21.20 mm
	A2S wiring package( with heat sink)	76.00*31.50*25.10 mm
	A4S rail package( without heat sink)	76.00*31.50*25.80 mm
	A4S rail package( with heat sink)	76.00*31.50*29.70 mm
Weight	without heat sink	Horizontal package/A2S wiring package/A4S rail package 26.00g/48.00g/68.00g(Typ.)
	with heat sink	Horizontal package/A2S wiring package/A4S rail package 34.00g/56.00g/76.00g(Typ.)
Cooling Method		Free air convection

EMC Specifications

EMI	CE	CISPR22/EN55022	CLASS A (Bare component)/ CLASS B (see Fig.3-② for recommended circuit)
	RE	CISPR22/EN55022	CLASS A (Bare component)/ CLASS B (see Fig.3-② for recommended circuit)
EMS	ESD	IEC/EN61000-4-2	Contact ±4KV perf. Criteria B
	RS	IEC/EN61000-4-3	10V/m perf. Criteria A
	EFT	IEC/EN61000-4-4	±2KV (see Fig.3-① for recommended circuit) perf. Criteria B
	Surge	IEC/EN61000-4-5	±2KV (see Fig.3-① for recommended circuit) perf. Criteria B
	CS	IEC/EN61000-4-6	3 Vr.m.s perf. Criteria A
	Voltage dips, short interruptions and variations immunity	IEC/EN61000-4-29	0-70% perf. Criteria B

Product Characteristic Curve

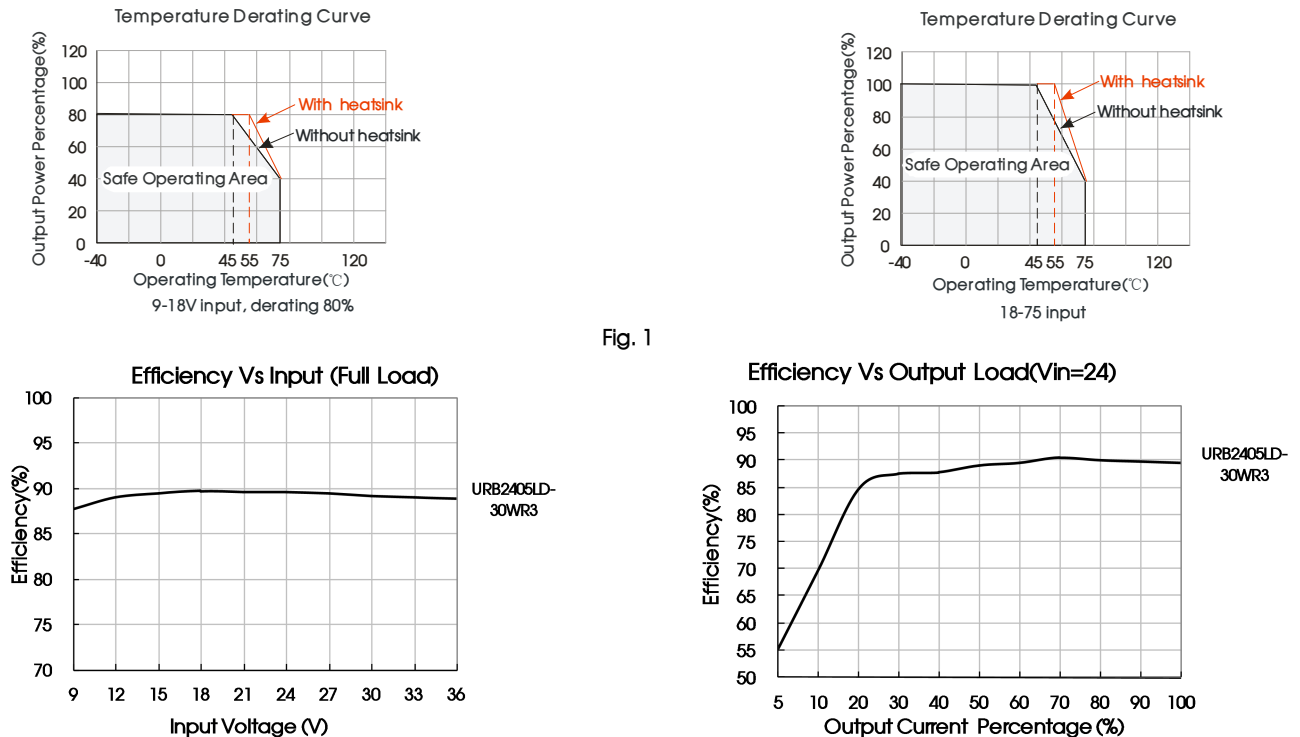

Fig. 1

Design Reference

1. Typical application

All the DC/DC converters of this series are tested according to the recommended circuit (see Fig. 2) before delivery. If it is required to further reduce input and output ripple, properly increase the input & output of additional capacitors Cin and Cout or select capacitors of low equivalent impedance provided that the capacitance is no larger than the max. capacitive load of the product.

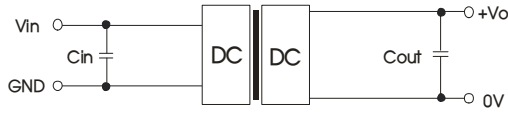

Fig. 2

Vout(VDC)	Cout(μF)	Cin(μF)
3.3/5/9	220	100
12/15/24	100	

2. EMC solution-recommended circuit

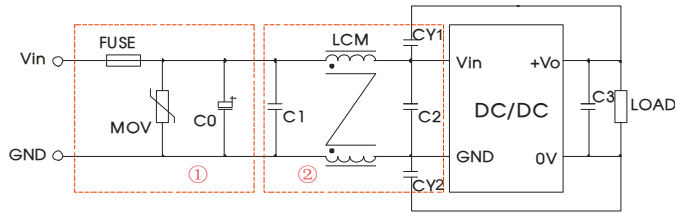

Fig. 3

Notes: Part ① in the Fig. 3 is used for EMS test and part ② for EMI filtering; selected based on needs.

Parameter description

Model	Vin:24V	Vin:48V
FUSE	Choose according to actual input current	
MOV	S14K35	S14K60
C0	330μF/50V	330μF/100V
C, C2	4.7μF/50V	2.2μF/100V
C3	Refer to the Cout in Fig.2	
LCM	1mH	
CY1, CY2	1nF/2KV	

EMC solution-recommended circuit PCB layout

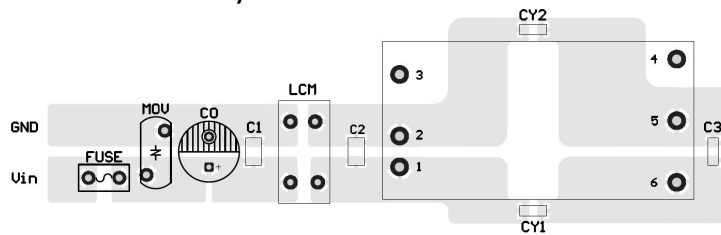
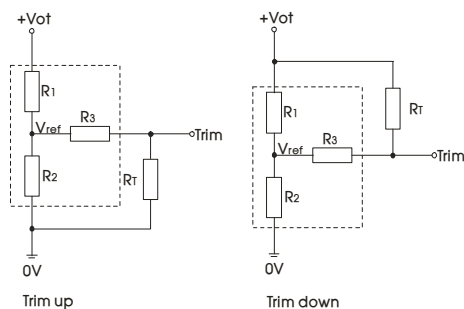

Fig. 4

Note: the min. distance of the bonding pads between input & output isolation capacitors (CY1/CY2) shall be ≥ 2mm.

3. Application of Trim and calculation of Trim resistance



Calculation formula of Trim resistance:

$$\begin{aligned} \text{up: } R_T &= \frac{\alpha R_2}{R_2 - \alpha} - R_3 & \alpha &= \frac{V_{ref}}{V_{o'} - V_{ref}} \cdot R_1 \\ \text{down: } R_T &= \frac{\alpha R_1}{R_1 - \alpha} - R_3 & \alpha &= \frac{V_{o'} - V_{ref}}{V_{ref}} \cdot R_2 \end{aligned}$$

R<sub>T</sub> is Trim resistance  
α is a self-defined parameter, with no real meaning.

Applied circuits of Trim (Part in broken line is the interior of models)

Vout(V)	R1(KΩ)	R2(KΩ)	R3(KΩ)	Vref(V)
3.3	4.801	2.87	12.4	1.25
5	2.883	2.87	10	2.5
9	7.500	2.87	15	2.5
12	11.000	2.87	15	2.5
15	14.494	2.87	15	2.5
24	24.872	2.87	17.8	2.5

4. It is not allowed to connect modules output in parallel to enlarge the power

5. For more information please find DC-DC converter application notes on [www.mornsun-power.com](http://www.mornsun-power.com)

Horizontal Package (without heat sink) Dimensions and Recommended Layout

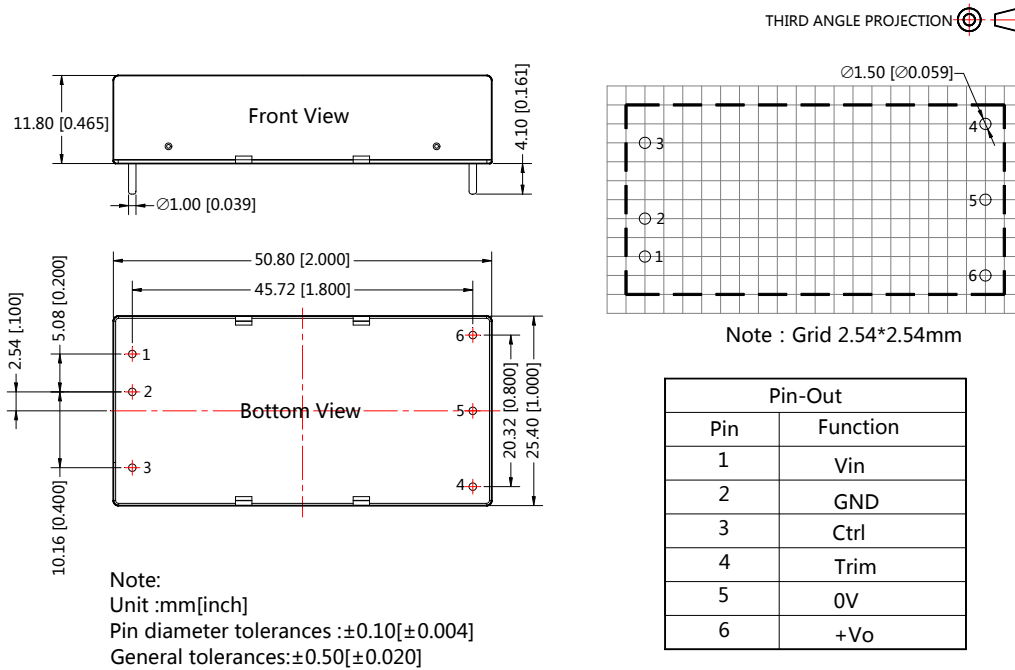

Horizontal Package (with heat sink) Dimensions

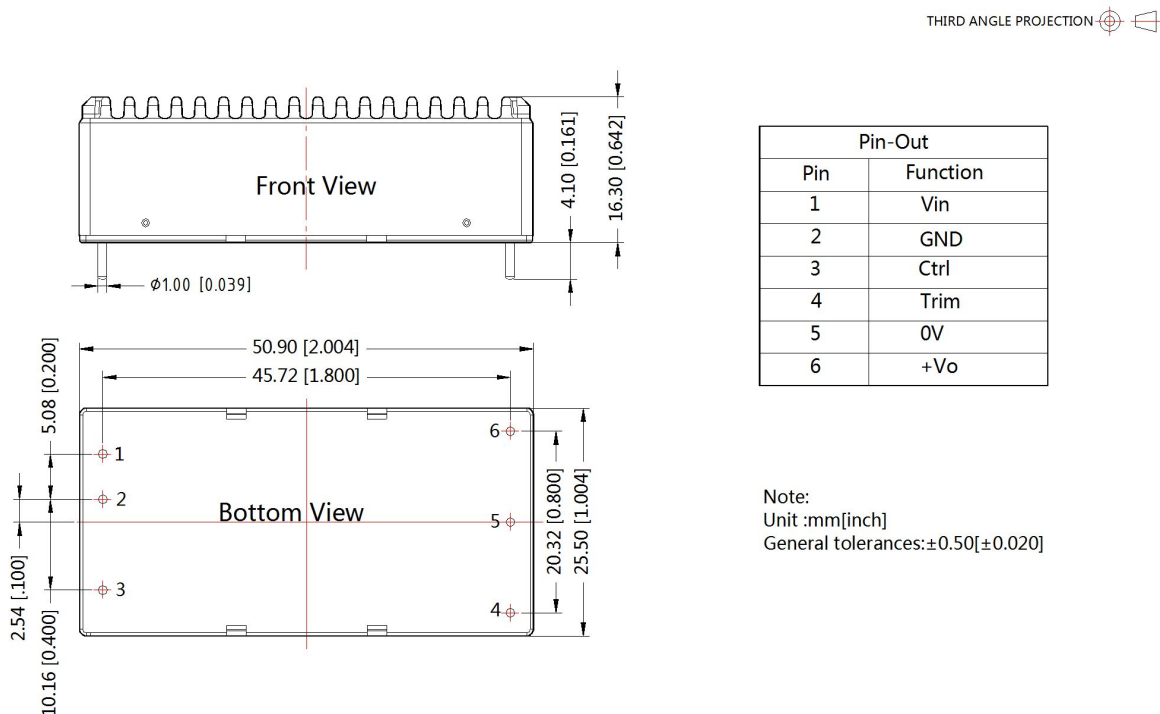

URB\_LD-30WR3A2S(without heat sink) Dimensions

THIRD ANGLE PROJECTION 

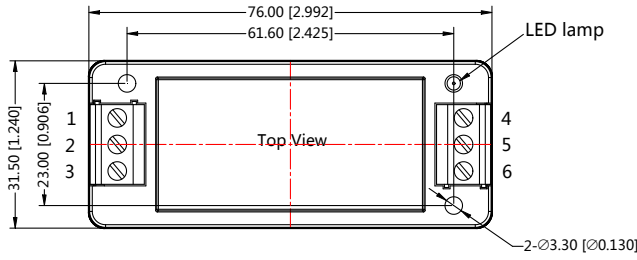

Pin-Out						
Pin	1	2	3	4	5	6
Function	Ctrl	GND	Vin	Trim	0V	+Vo

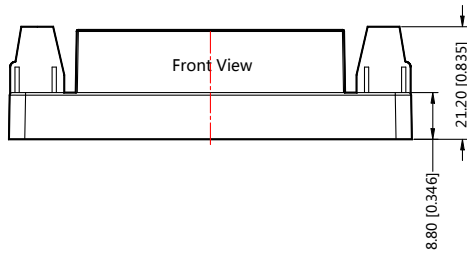

Note:  
Unit:mm[inch]  
Wire range : 24~12 AWG  
General tolerances:±0.50[±0.020]

URB\_LD-30WHR3A2S(with heat sink) Dimensions

THIRD ANGLE PROJECTION 

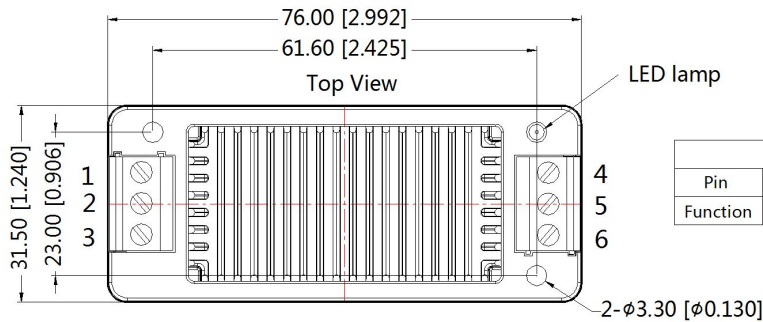

Pin-Out						
Pin	1	2	3	4	5	6
Function	Ctrl	GND	Vin	Trim	0V	+Vo

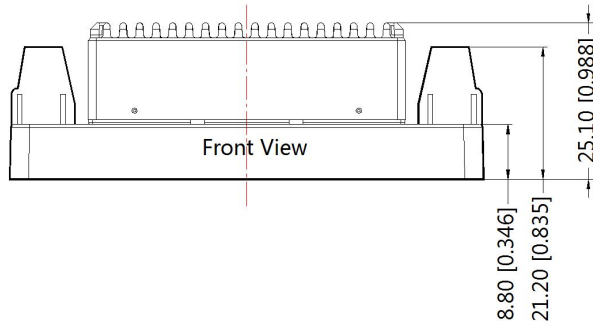

Note:  
Unit:mm[inch]  
Wire range:24~12 AWG  
General tolerances:±0.50[±0.020]

URB\_LD-30WR3A4S(without heat sink) Dimensions

THIRD ANGLE PROJECTION 

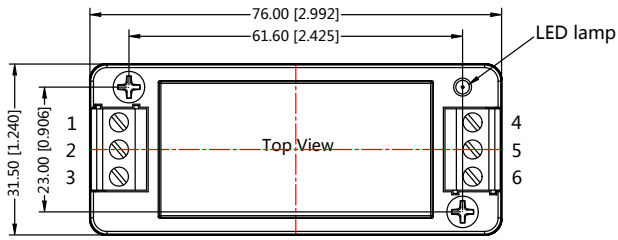

Pin-Out						
Pin	1	2	3	4	5	6
Function	Ctrl	GND	Vin	Trim	0V	+Vo

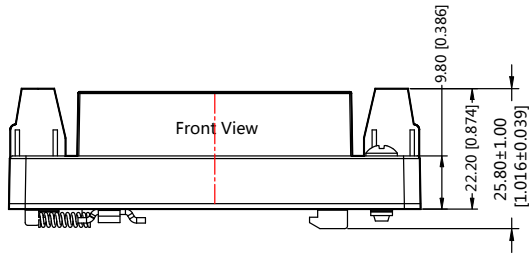

Note:  
Unit:mm[inch]  
Wire range : 24~12 AWG  
General tolerances:±0.50[±0.020]

URB\_LD-30WHR3A4S(with heat sink) Dimensions

THIRD ANGLE PROJECTION 

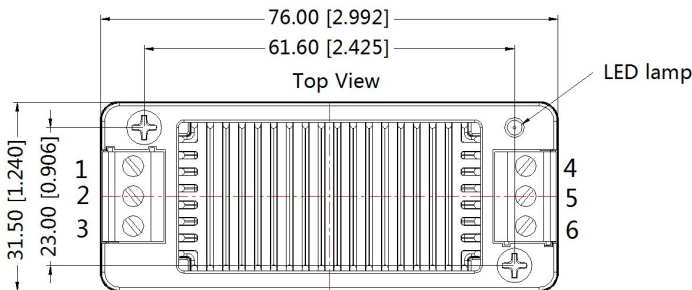

Pin-Out						
Pin	1	2	3	4	5	6
Function	Ctrl	GND	Vin	Trim	0V	+Vo

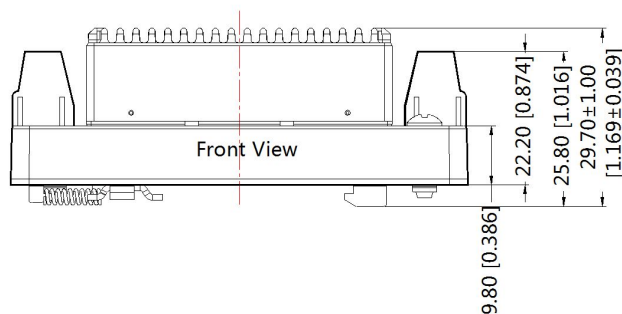

Note:  
Unit:mm[inch]  
Wire range:24~12 AWG  
General tolerances:±0.50[±0.020]

Notes:

1. Packing information please refer to Product Packing Information which can be downloaded from [www.mornsun-power.com](http://www.mornsun-power.com).  
Horizontal Packing Bag Number: 58200035(without heat sink), 58200051(with heat sink), A2S/A4S Packing Bag Number: 58220022;
2. The maximum capacitive load offered were tested at nominal input voltage and full load;
3. Unless otherwise specified, parameters in this datasheet were measured under the conditions of  $T_a=25^{\circ}\text{C}$ , humidity<75% with nominal input voltage and rated output load;
4. All index testing methods in this datasheet are based on our Company's corporate standards;
5. The performance parameters of the product models listed in this manual are as above, but some parameters of non-standard model products may exceed the requirements mentioned above. Please contact our technicians directly for specific information;
6. We can provide product customization service;
7. Specifications are subject to change without prior notice.

## Mornsun Guangzhou Science & Technology Co., Ltd.

Address: No. 5, Kehui St. 1, Kehui Development Center, Science Ave., Guangzhou Science City, Luogang District, Guangzhou, P. R. China  
Tel: 86-20-38601850-8801 Fax: 86-20-38601272 E-mail: [info@mornsun.cn](mailto:info@mornsun.cn)