

### GENERAL DESCRIPTION

This Trench MOSFET has better characteristics, such as fast switching time, low on resistance, low gate charge and excellent avalanche characteristics. It is mainly suitable for load switch and Back light inverter.

### FEATURES

- $V_{DSS}=60V$ ,  $I_D=4.5A$ .
- Drain-Source ON Resistance.  
 $R_{DS(ON)}=56m$  (Max.) @  $V_{GS}=10V$   
 $R_{DS(ON)}=77m$  (Max.) @  $V_{GS}=4.5V$

### MOSFET Maximum Ratings (Ta=25 Unless otherwise noted)

CHARACTERISTIC	SYMBOL	PATING	UNIT
Drain Source Voltage	$V_{DSS}$	60	V
Gate Source Voltage	$V_{GSS}$	$\pm 20$	V
Drain Current	DC@Ta=25	$I_D^*$	4.5 A
	Pulsed	$I_{DP}$	20 A
Drain Source Diode Forward Current	$I_S$	3	A
Drain Power Dissipation	@Ta=25	$P_D^*$	2 W
Maximum Junction Temperature	$T_j$	150	
Storage Temperature Range	$T_{stg}$	-55~150	
Thermal Resistance, Junction to Ambient	$R_{thJA}^*$	62.5	/W

Note> \*Surface Mounted on 1 × 1 FR4 Board, t 10sec.

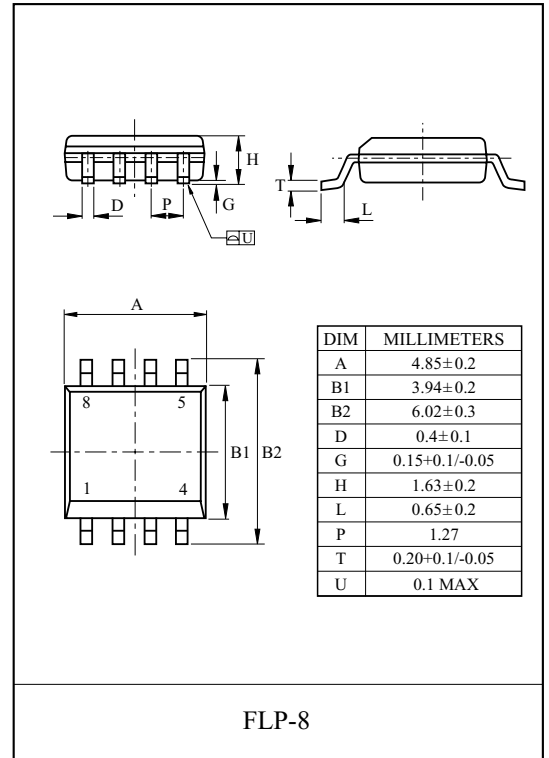

### Marking

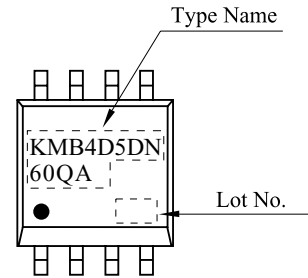

### PIN CONNECTION (TOP VIEW)

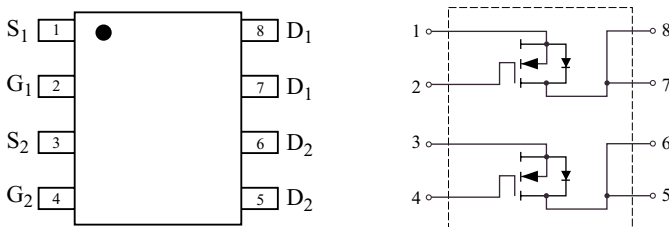

# KMB4D5DN60QA

## ELECTRICAL CHARACTERISTICS (Ta=25 ) UNLESS OTHERWISE NOTED

CHARACTERISTIC	SYMBOL	TEST CONDITION	MIN.	TYP.	MAX.	UNIT		
<b>Static</b>								
Drain-Source Breakdown Voltage	$BV_{DSS}$	$V_{GS}=0V, I_{DS}=250\ \mu A$	60	-	-	V		
Drain Cut-off Current	$I_{DSS}$	$V_{GS}=0V, V_{DS}=48V$	-	-	1	$\mu A$		
Gate Leakage Current	$I_{GSS}$	$V_{GS}=\pm 20V, V_{DS}=0V$	-	-	$\pm 100$	nA		
Gate Threshold Voltage	$V_{th}$	$V_{DS}=V_{GS}, I_D=250\ \mu A$	1.0	-	3.0	V		
Drain-Source ON Resistance	$R_{DS(ON)}^*$	$V_{GS}=10V, I_D=4.5A$	-	46	56	m		
		$V_{GS}=4.5V, I_D=3A$	-	64	77			
Forward Transconductance	$g_{fs}^*$	$V_{DS}=5V, I_D=4.5A$	-	11	-	S		
<b>Dynamic</b>								
Input Capacitance	$C_{iss}^*$	$V_{DS}=30V, V_{GS}=0V, f=1MHz$	-	490	-	pF		
Output Capacitance	$C_{oss}^*$		-	45	-			
Reverse Transfer Capacitance	$C_{rss}^*$		-	25	-			
Total Gate Charge	$V_{GS}=10V$	$V_{DS}=30V, V_{GS}=10V, I_D=4.5A$	$Q_g^*$	-	10.4	-	nC	
	$V_{GS}=4.5V$		$Q_g^*$	-	5.1	-		
Gate-Source Charge	$Q_{gs}^*$		-	2.3	-			
Gate-Drain Charge	$Q_{gd}^*$		-	2.2	-			
Turn-On Delay Time	$t_{d(on)}^*$		$V_{DS}=30V, V_{GS}=10V$ $I_D=4.5A, R_G=3$	-	12.4	-		ns
Turn-On Rise Time	$t_r^*$			-	34.5	-		
Turn-Off Delay Time	$t_{d(off)}^*$	-		30.7	-			
Turn-Off Fall Time	$t_f^*$	-		5.0	-			
<b>Source-Drain Diode Ratings</b>								
Source-Drain Forward Voltage	$V_{SDF}^*$	$V_{GS}=0V, I_S=1A$	-	0.7	1.0	V		
Note> *Pulse Test : Pulse Width 300 $\mu s$ , Duty Cycle 2%								

# KMB4D5DN60QA

Fig1.  $I_D - V_{DS}$

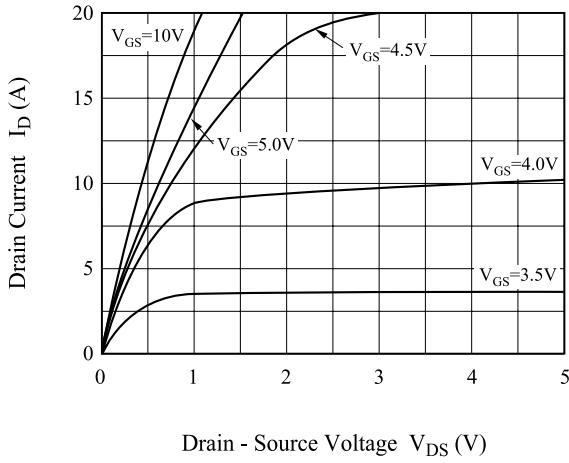

Fig2.  $R_{DS(ON)} - I_D$

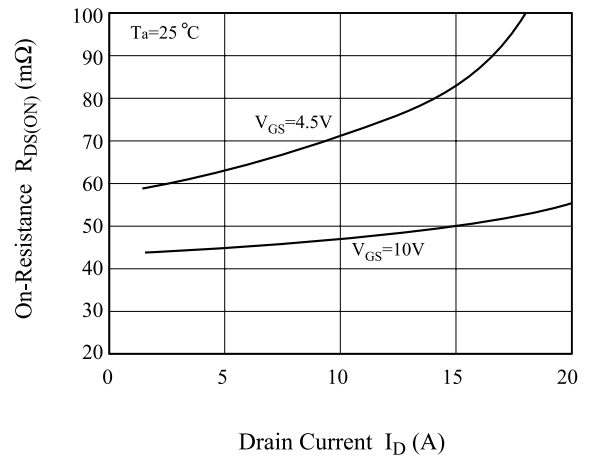

Fig3.  $I_D - V_{GS}$

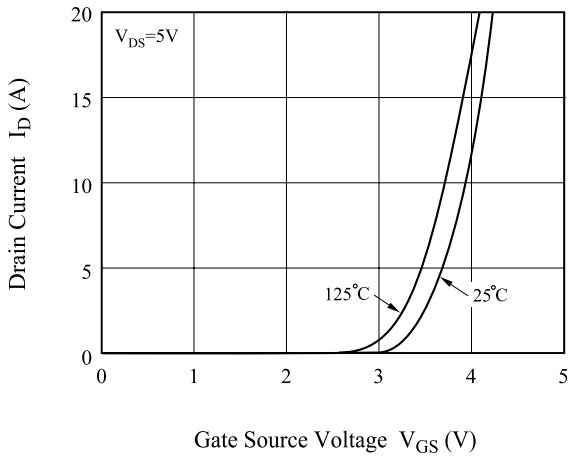

Fig4.  $R_{DS(on)} - T_j$

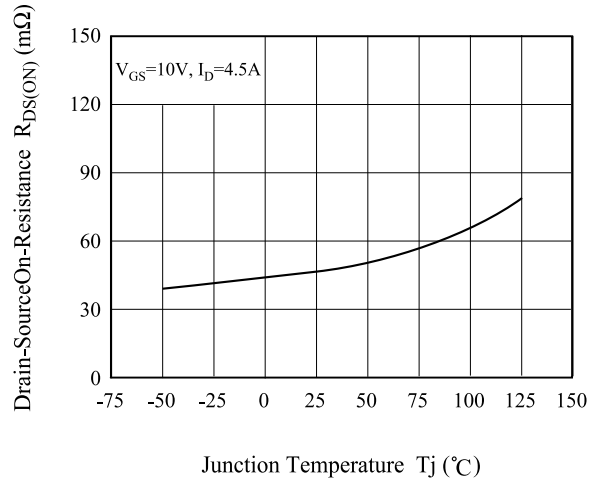

Fig5.  $V_{th} - T_j$

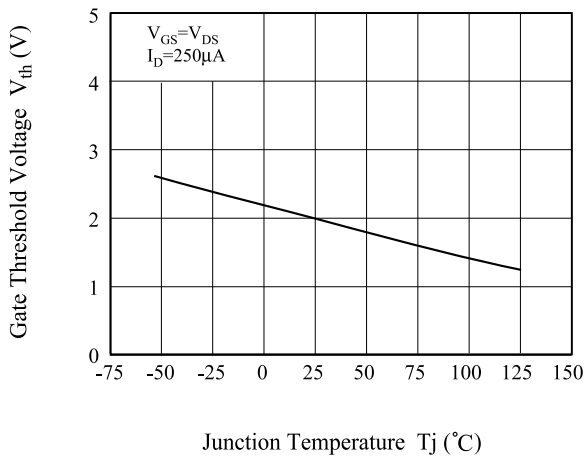
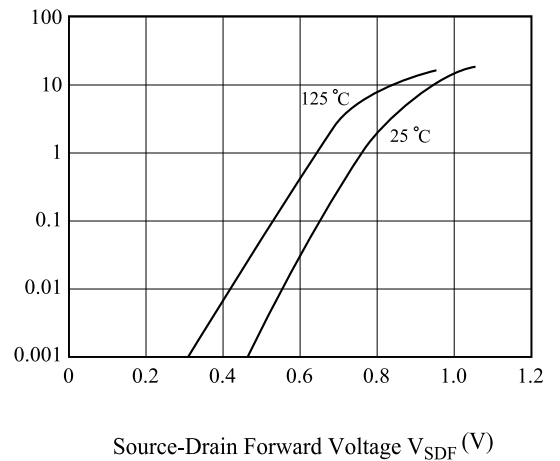

Fig 6.  $I_S - V_{SDF}$



# KMB4D5DN60QA

Fig7.  $V_{GS} - Q_g$

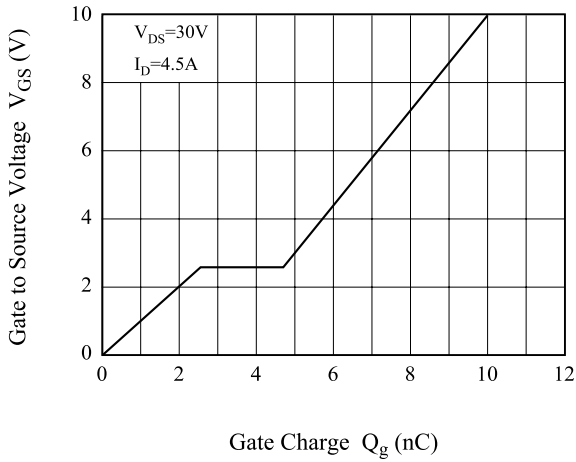

Fig8.  $C - V_{DS}$

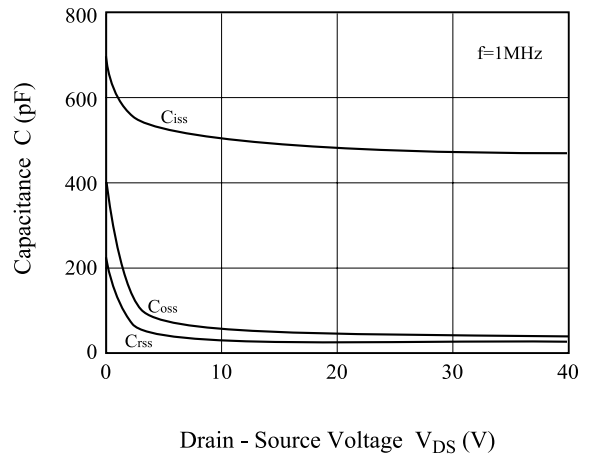

Fig9. Safe Operation Area

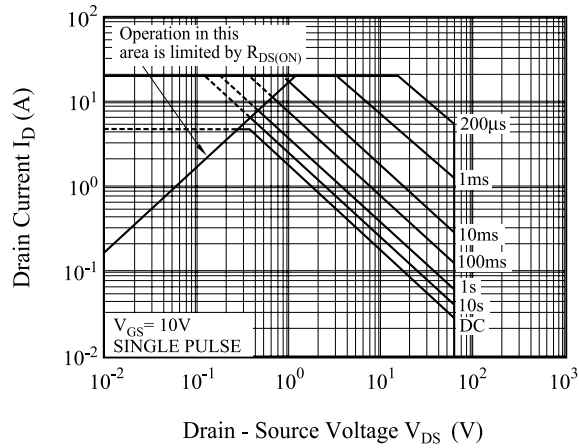

Fig9. Transient Thermal Response Curve

