

DATE	SYM.	DESCRIPTION	DR	CK	REL

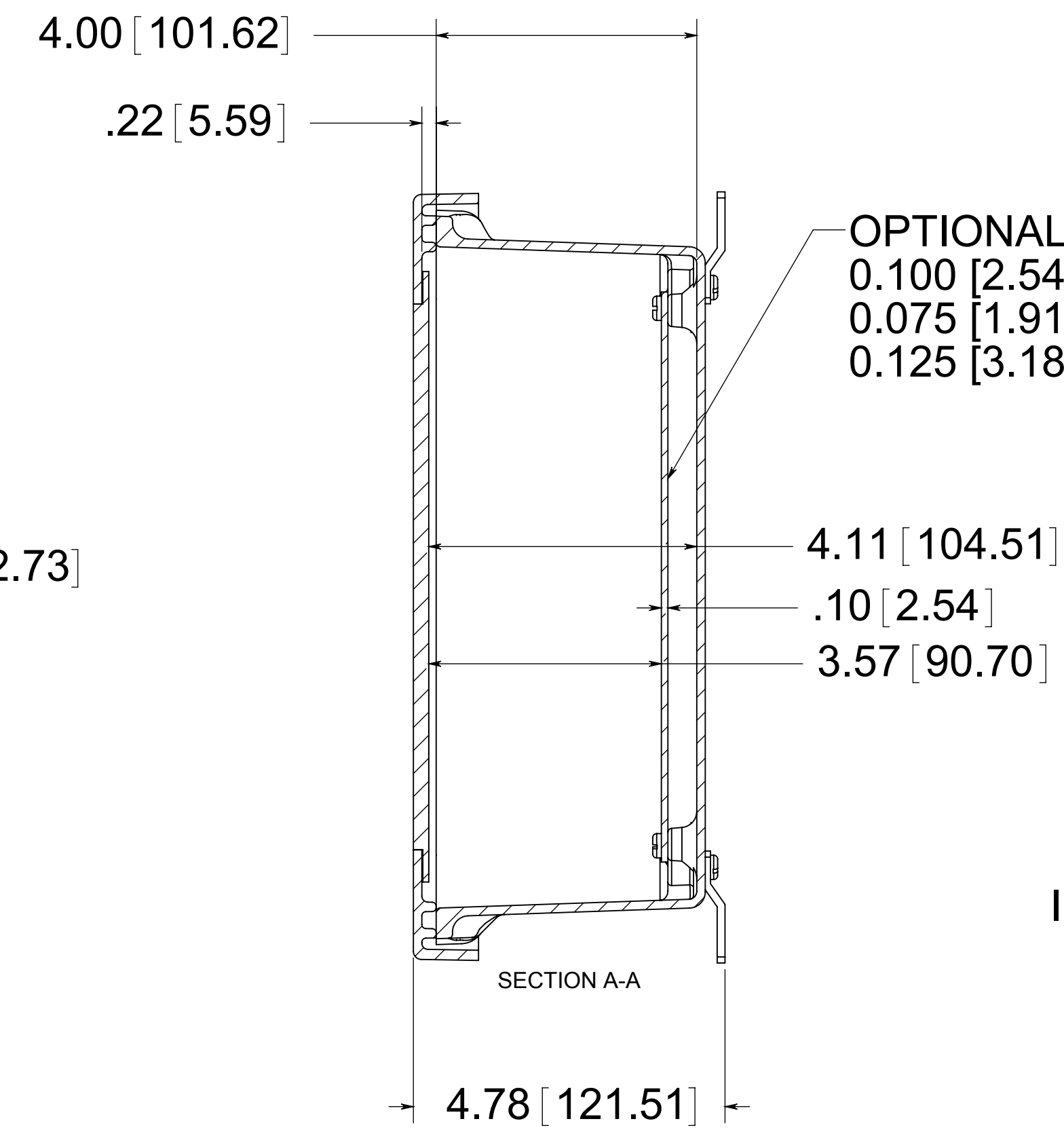
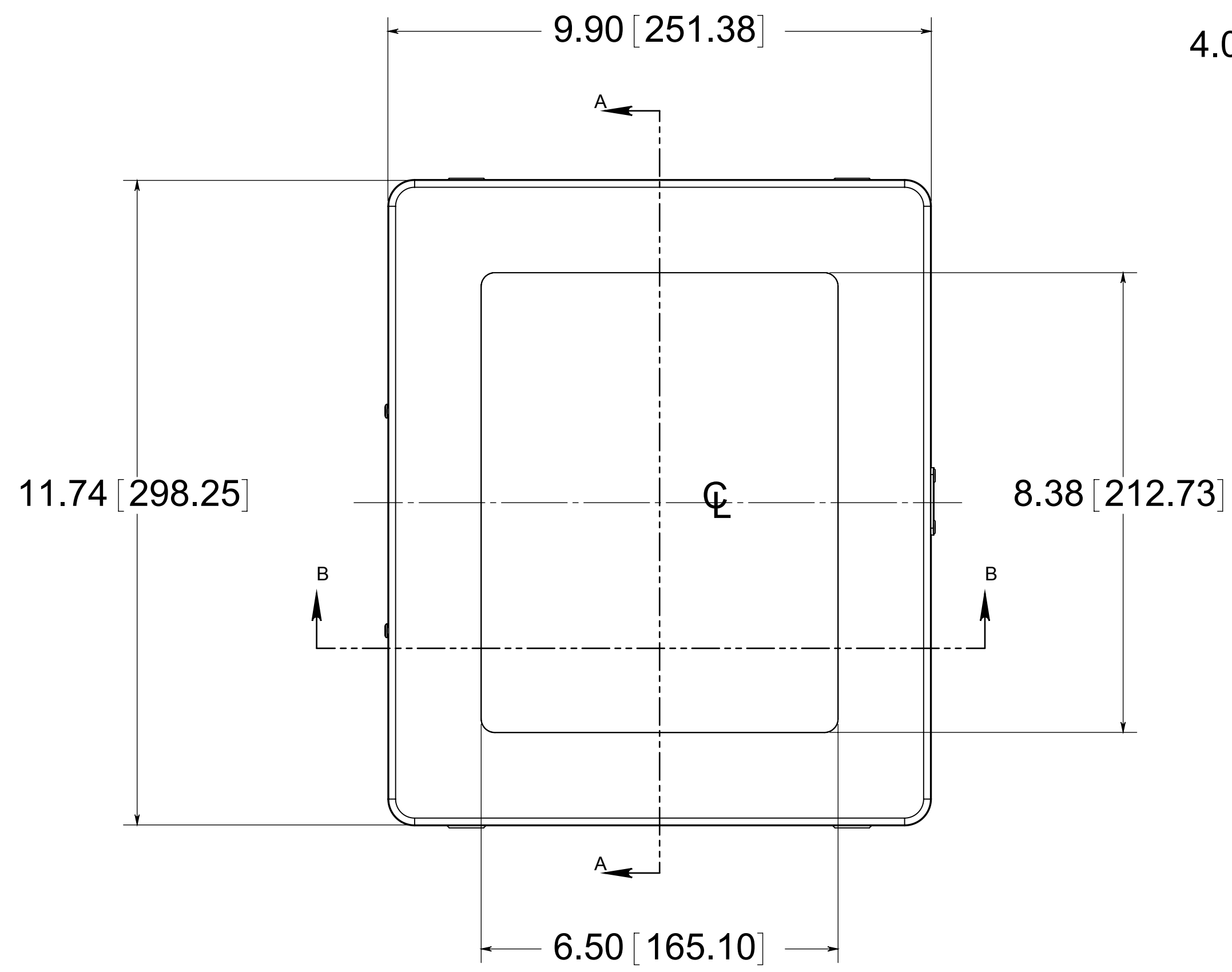

OPTIONAL BACK PANEL
 0.100 [2.54] TH'K- ALUMINUM
 0.075 [1.91] TH'K- WHITE STEEL & GALVANNEALED
 0.125 [3.18] TH'K- FIBERGLASS

(4) STAINLESS STEEL MOUNTING FEET
 (4) EACH #10-32 BRASS INSERTS, AND STAINLESS STEEL FEET SCREWS

(4) ϕ .34 [8.74]

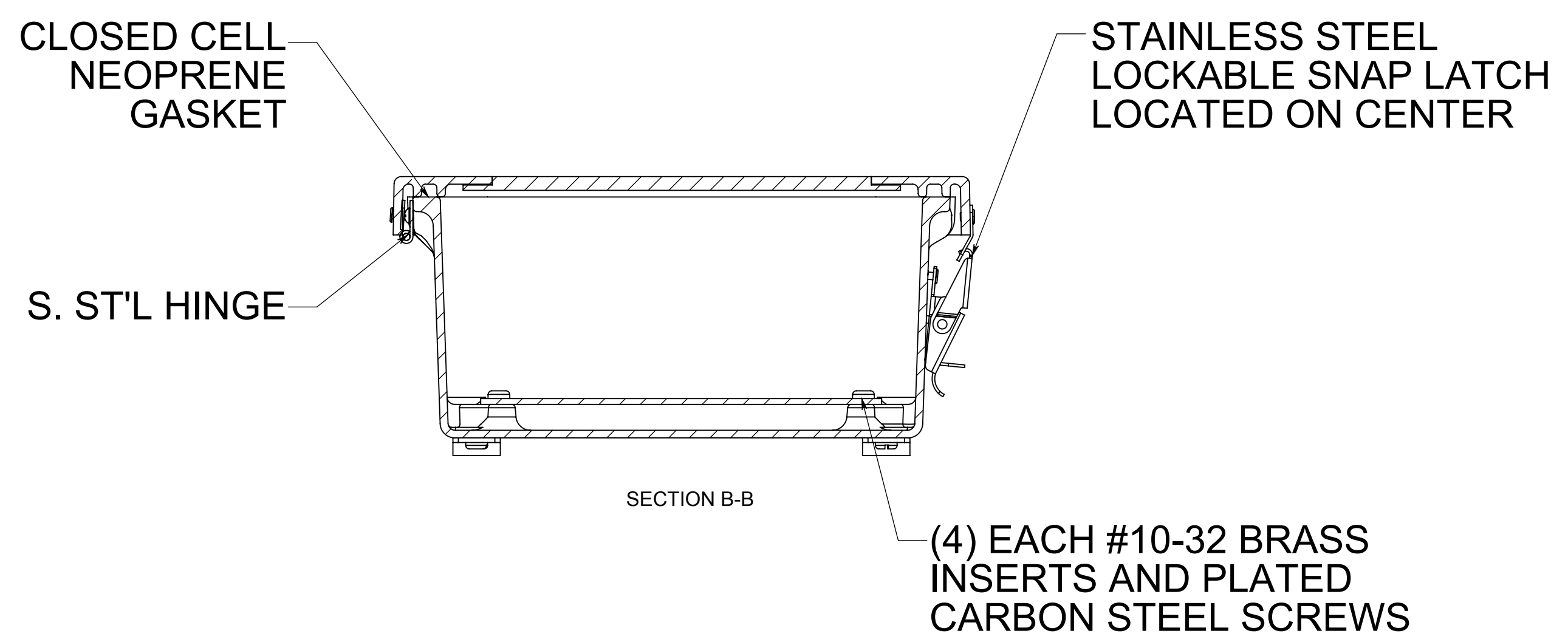
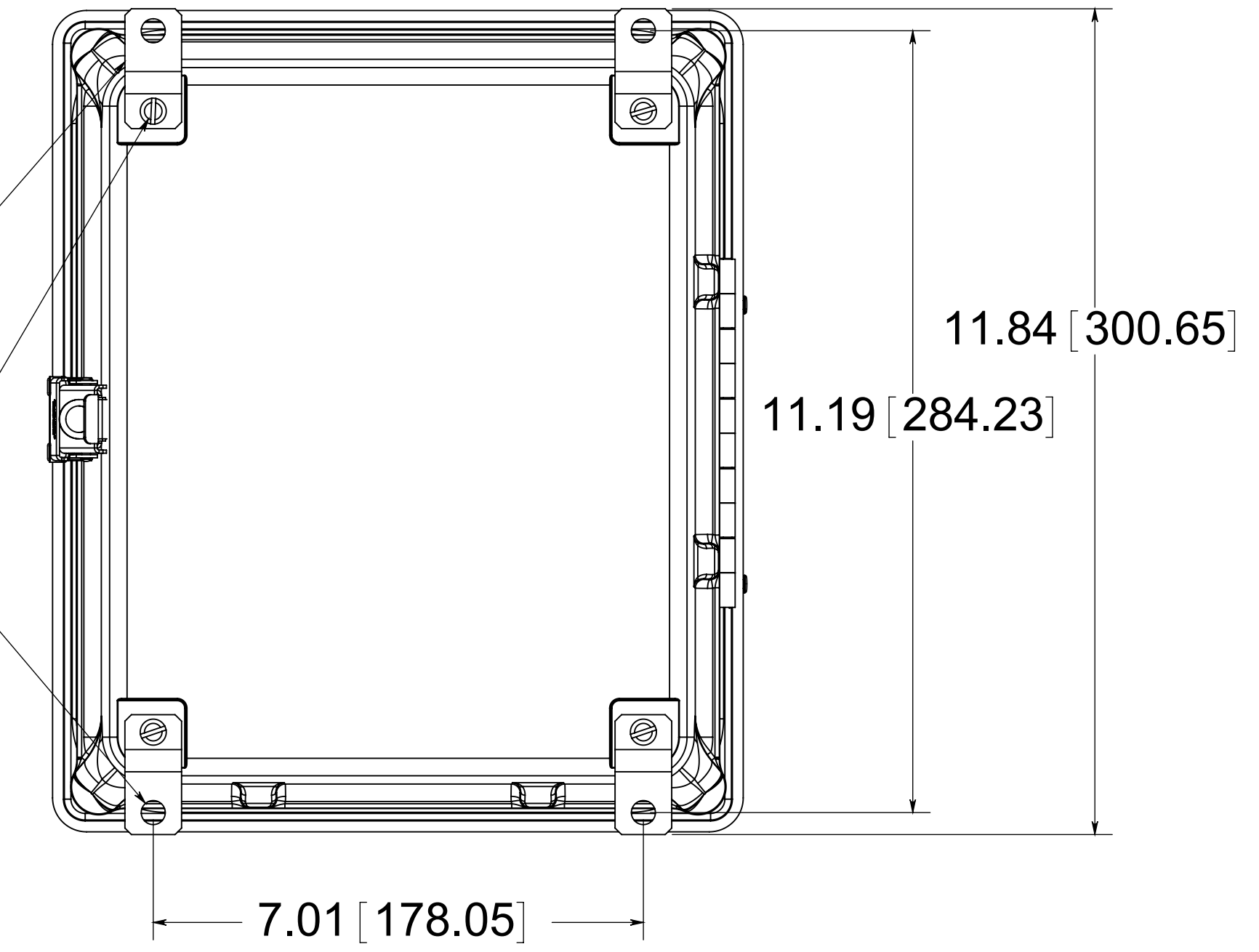

FRONT VIEW WITH COVER REMOVED AND BACK PANEL SHOWN

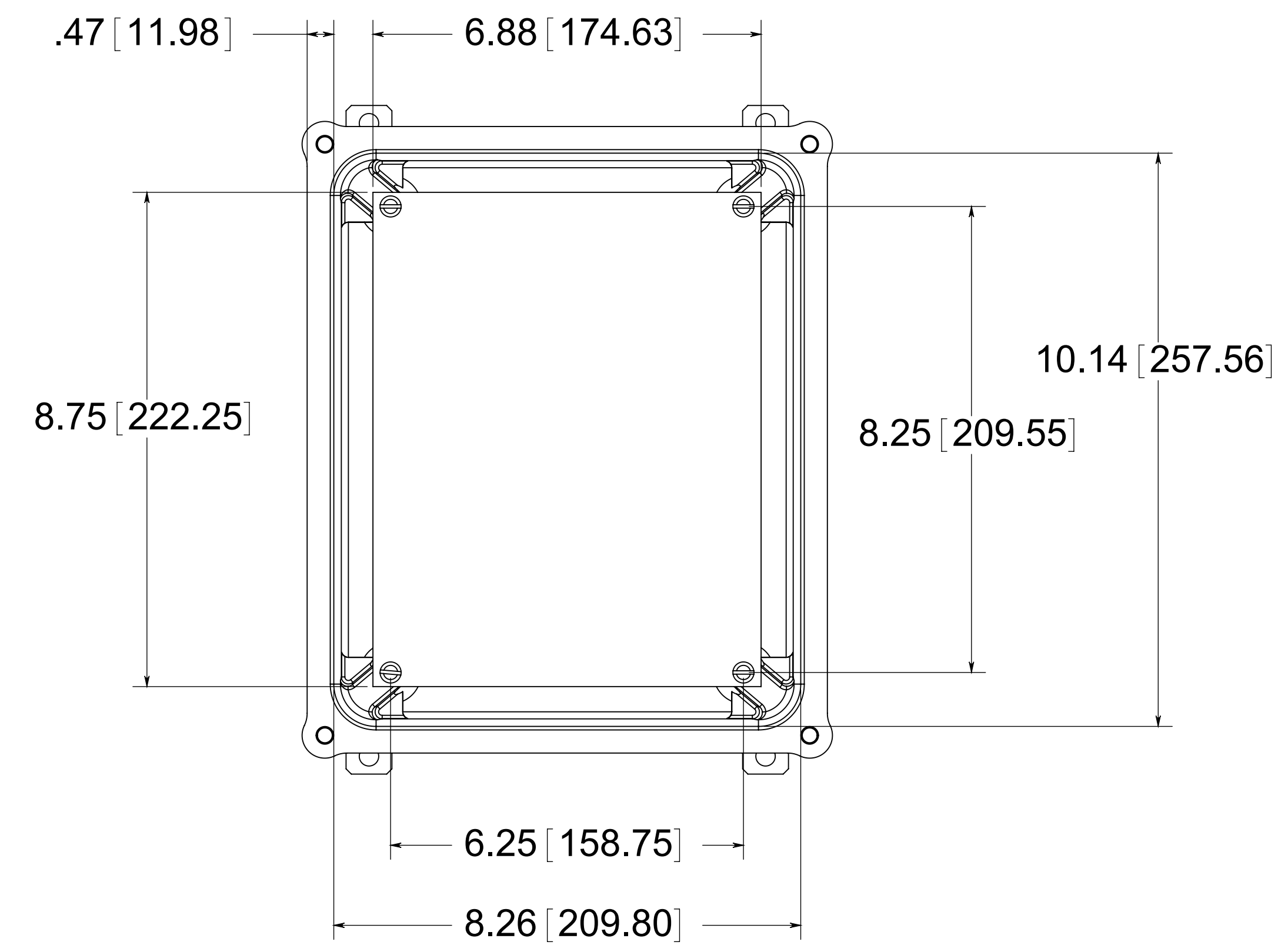

MATERIAL:
 BOX- COMPRESSION MOLDED FIBERGLASS REINFORCED POLYESTER
 COVER- COMPRESSION MOLDED FIBERGLASS REINFORCED POLYESTER
 WINDOWS- POLYCARBONATE

PART No. PJ1084LW
 for more information visit www.hammfg.com
 Data subject to change without notice
 Drawing Not to Scale