

SAW Bandpass Filter F1G5C



Features

- GPS applications
- Usable bandwidth of 2 MHz
- No impedance matching require for operation at 50 Ω
- SMD Package 2.0 mm × 1.6 mm × 0.75 mm
- Single-ended Operation
- RoHS Compliant

Package Dimensions

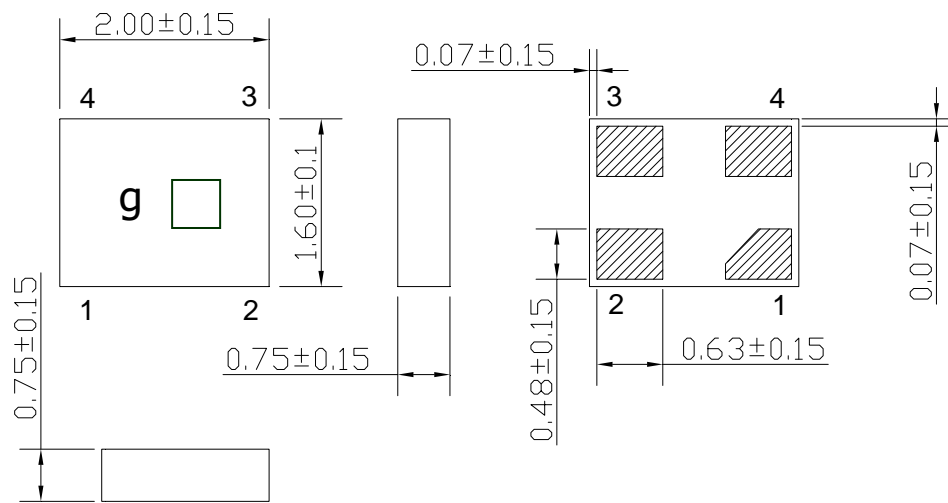

Dimensions shown are nominal in millimeters

Body : Al₂O₃ Ceramic

Lid : Kovar, Ni Plated

Terminations : Au plating 0.3 ~ 1.0 um, Over a 1.27 ~ 8.89 um
Ni Plating

Pin Configurations	
1	Input
3	Output
2, 4	Case ground

Maximum Ratings

Parameters	Unit	Minimum	Typical	Maximum
Operating Temperature Range	℃	-40	25	85
Storage Temperature Range	℃	-40	25	85
Power Handling Capability	dBm	-	-	10

Electrostatics Sensitive Device (ESD)

	ITF Co., Ltd. 102-901, Bucheon Technopark 364, Samjeong-Dong, Ojeong-Gu, Bucheon-City, Gyeonggi-Do, Korea 421-809	Part No.	F1G5C	
		Rev. Date	2011-07-27	
		Rev.	NCMG01-AS01	1/7

SAW Bandpass Filter F1G5C



Specifications

$F_c = 1575.42 \text{ MHz}$

Terminating source impedance : 50Ω

Terminating load impedance : 50Ω

	Minimum	Typical	Maximum	Unit
Center Frequency (F_c)	-	1575.42	-	MHz
Insertion Loss ($F_o \pm 1 \text{ MHz}$)	-	1.2	1.6	dB
Amplitude Ripple ($F_o \pm 1 \text{ MHz}$)	-	0.1	1.0	dBp-p
VSWR ($F_o \pm 1 \text{ MHz}$)	-	1.2	2.0	
Relative Attenuation				
D.C. ~ 1000 MHz	20.0	34.0	-	dB
1500 MHz	33.0	38.0	-	
1625 ~ 1635 MHz	30.0	39.0	-	
1800 ~ 3000 MHz	25.0	32.0	-	
Input/Output Impedance		50		Ohms

Notes :

- 1) All specifications are based on the matching schematic shown below, measured by Agilent Network analyzer and full 2 port calibration.
- 2) Electrical margin has been built into the design to account for the variations due to temperature drift and manufacturing tolerances
- 3) All attenuation measurements are measured relative to insertion loss

 Integrated Technology Future	ITF Co., Ltd. 102-901, Bucheon Technopark 364, Samjeong-Dong, Ojeong-Gu, Bucheon-City, Gyeonggi-Do, Korea 421-809	Part No.	F1G5C	
		Rev. Date	2011-07-27	
		Rev.	NCMG01-AS01	2/7

SAW Bandpass Filter F1G5C



Matching Schematic

(Actual matching values may vary due to PCB layout and parasitics)

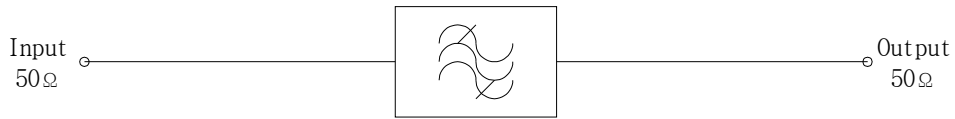

Marking Configuration

g¹⁾ ²⁾

- 1) Marking Number
- 2) Year / Month Code

 <small>Integrated Technology Future</small>	ITF Co., Ltd. 102-901, Bucheon Technopark 364, Samjeong-Dong, Ojeong-Gu, Bucheon-City, Gyeonggi-Do, Korea 421-809	Part No.	F1G5C	
		Rev. Date	2011-07-27	
		Rev.	NCMG01-AS01	3/7

SAW Bandpass Filter F1G5C



Typical Performance (at 25°C)

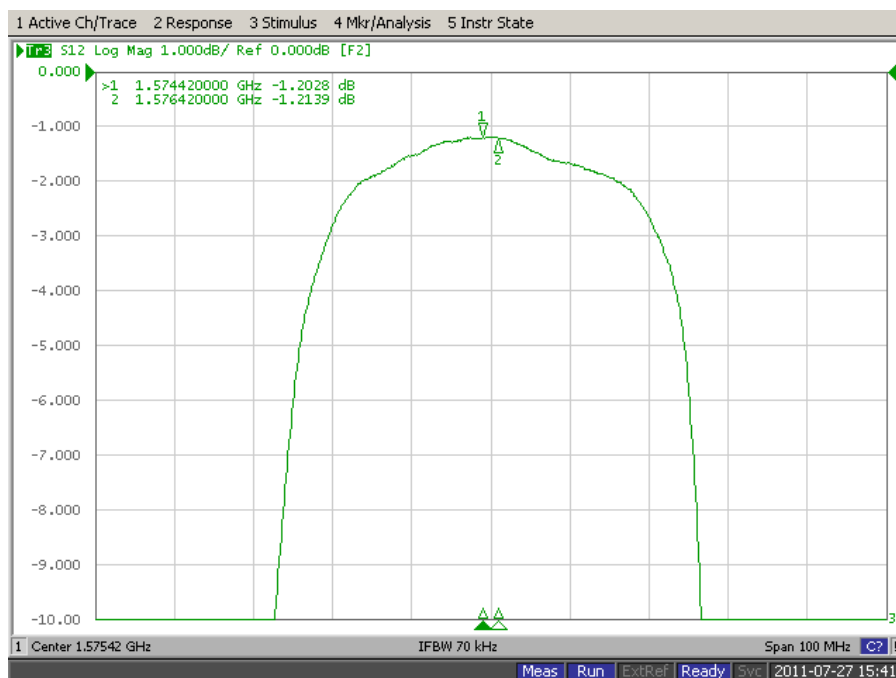
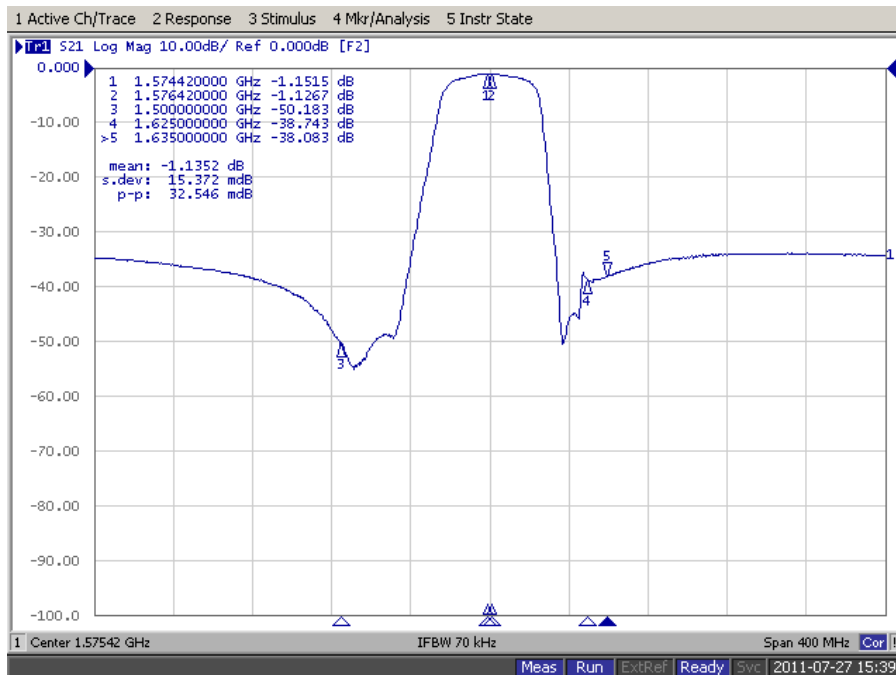

ITF Co., Ltd.
 102-901, Bucheon Technopark 364,
 Samjeong-Dong, Ojeong-Gu, Bucheon-City,
 Gyeonggi-Do, Korea 421-809

Part No.

F1G5C

Rev. Date

2011-07-27

Rev.

NCMG01-AS01

4/7

SAW Bandpass Filter F1G5C



Input / Output VSWR Charts

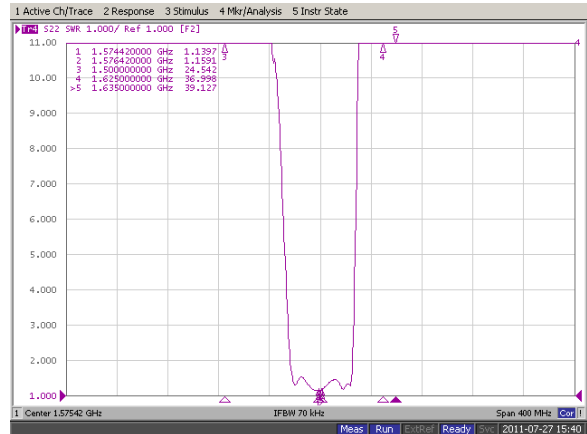
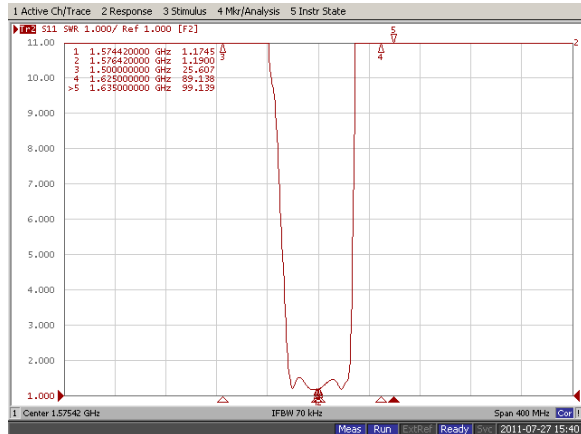

Input / Output Smith Charts

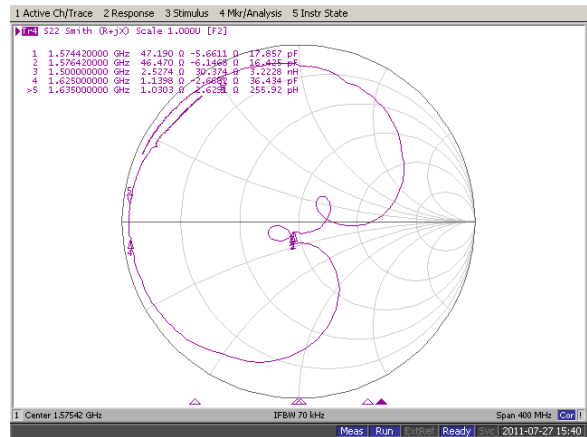
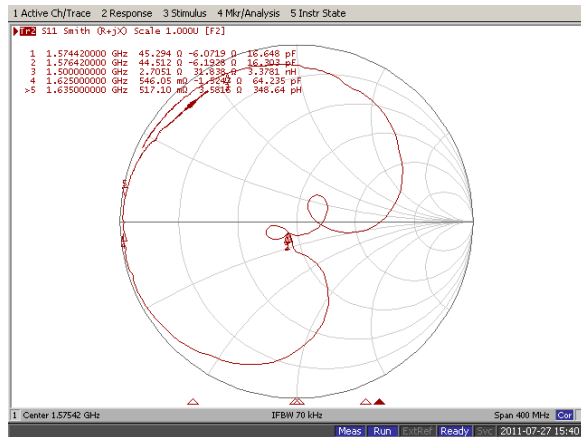

ITF Co., Ltd.
 102-901, Bucheon Technopark 364,
 Samjeong-Dong, Ojeong-Gu, Bucheon-City,
 Gyeonggi-Do, Korea 421-809

Part No.

F1G5C

Rev. Date

2011-07-27

Rev.

NCMG01-AS01

5/7

Packing Specification

1. Reeling Quantity : 3000 pcs / 13" reel (or 1000 pcs / 7" reel)
2. Taping Structure : The tape shall be wound around the reel in the direction shown below.

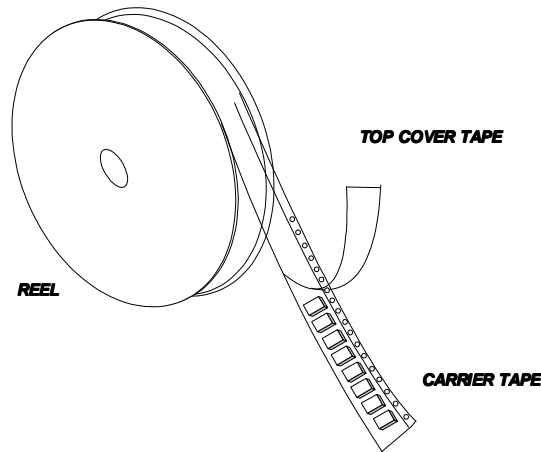

Tape Specification

1. Leader part and vacant position specification

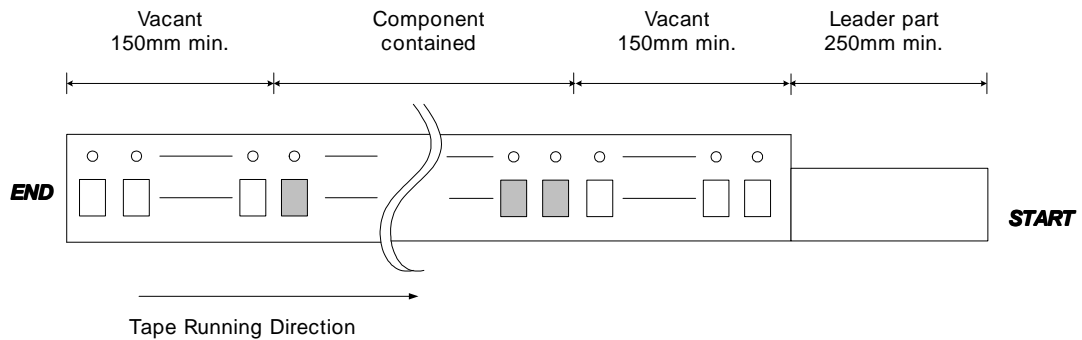

2. Tensile strength of carrier tape

4.4N/mm width

3. Top cover tape adhesion

- 1) pull off angle : 0~15°
- 2) speed : 300mm/min
- 3) force : 20~70g

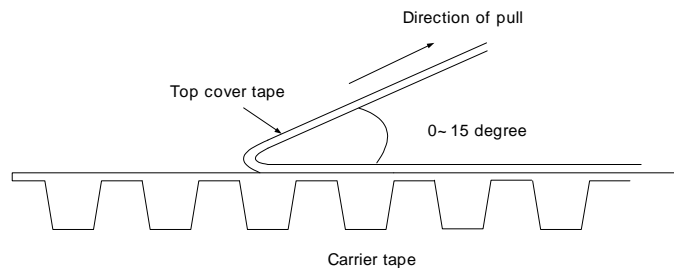

	ITF Co., Ltd. 102-901, Bucheon Technopark 364, Samjeong-Dong, Ojeong-Gu, Bucheon-City, Gyeonggi-Do, Korea 421-809	Part No.	F1G5C	
		Rev. Date	2011-07-27	
		Rev.	NCMG01-AS01	6/7

SAW Bandpass Filter F1G5C



Carrier Tape Dimensions [unit : mm]

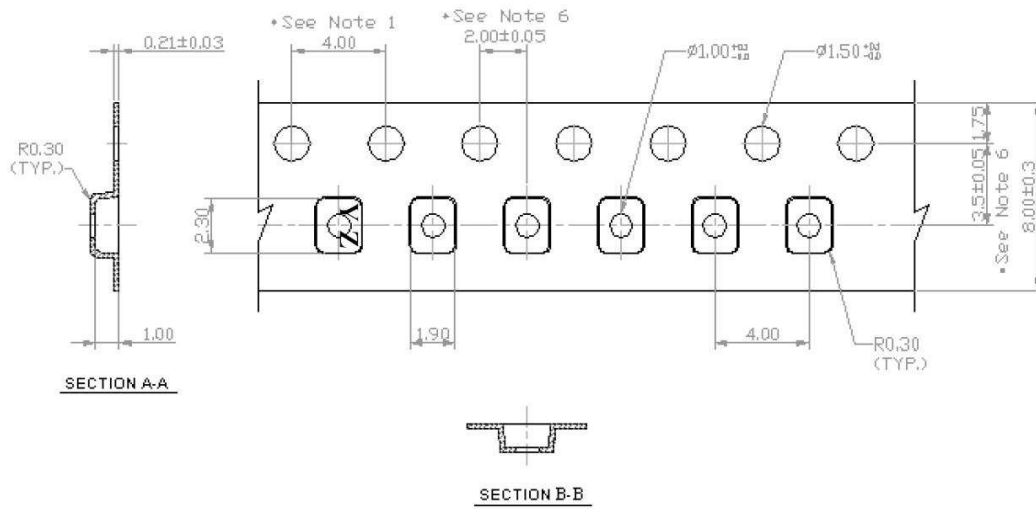

Part Direction

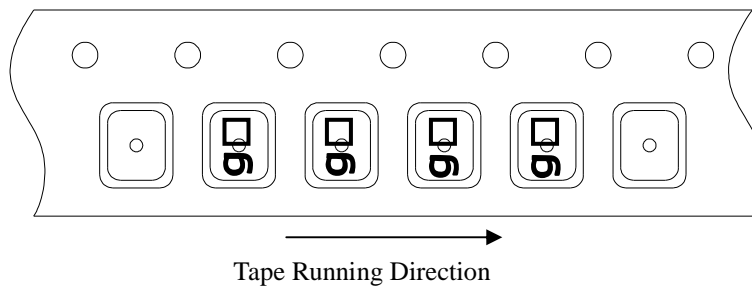

Reel Dimensions [unit : mm]

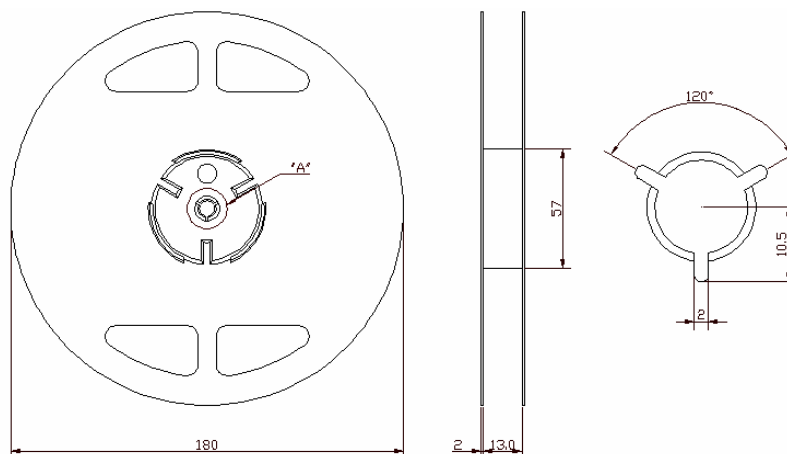

	ITF Co., Ltd. 102-901, Bucheon Technopark 364, Samjeong-Dong, Ojeong-Gu, Bucheon-City, Gyeonggi-Do, Korea 421-809	Part No.	F1G5C	
		Rev. Date	2011-07-27	
		Rev.	NCMG01-AS01	7/7