

Applications

- HFC Nodes
- CATV Line Amplifiers
- Head End Equipment

Product Features

- Excellent High Output Linearity
- High Gain 24dB @ 1000MHz
- 50MHz – 1000MHz Bandwidth
- Ultra-Low CSO/CTB/XMOD
- Low Noise
- Excellent Input/Output Match
- Variable Bias Control
- Compact Size
- High Reliability
- 24V, 445mA

General Description

The TAT9988 is an ultra-linear, packaged GaAs/GaN amplifier intended for output stage amplification in CATV infrastructure applications.

The TAT9988 features a push-pull cascode design which provides flat gain along with ultra-low distortion, making it ideal for use in CATV distribution systems requiring high output power capability.

The TAT9988 draws 445mA from a 24V supply and exceeds the output linearity performance of traditional GaAs-based amplifiers.

The TAT9988 allows users to adjust the bias current and the bias voltage externally in order to optimize output performance.

The TAT9988 is packaged in an industry standard 40 pin 5x7 mm² QFN package.

Standard SOT-115 Hybrid Modules are used as orderable evaluation board assemblies for the TAT9988. Please refer to the ordering information for more details.



40 Pin 5x7 mm QFN Package

Functional Block Diagram

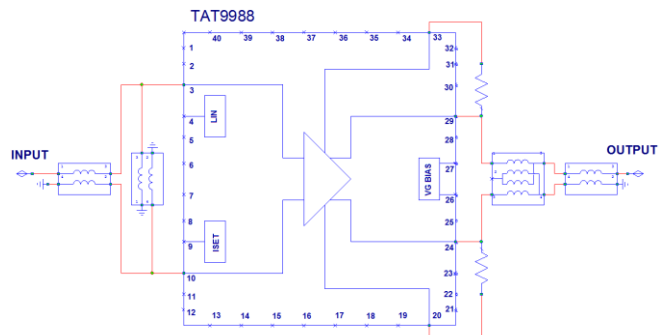

Pin Configuration

Pin No.	Label
3	Non-Inverting Amplifier Input
4	Linearizer Current-Adjust
6,7	Common Source Node
9	Amplifier Current-Adjust
10	Inverting Amplifier Input
20	Feedback to Inverting Input
24	Non-Inverting Amplifier Output
26	Output Device Gate Bias 1
27	Output Device Gate Bias 2
29	Inverting Amplifier Output
33	Feedback to Non-Inverting
1,2,5,8,11-12, 21-23,25, 28, 30-32,	No connect
13-19, 34-40	Ground

Ordering Information

Part No.	Description
TAT9988	CATV GaN Power Doubler MMIC
TAT8888	50-1000 MHz Hybrid Evaluation Board
TAT8888-1200	50-1200 MHz Hybrid Evaluation Board

Standard T/R size =1000 pieces on a 7" reel.

Absolute Maximum Ratings

Parameter	Rating
Storage Temperature	-40 to +100°C
RF Input Power, CW, 75Ω, T=25°C	70 dBmV
Supply Voltage (V _{DD})	+30 V
Supply Current (I _{DD})	600 mA

Operation of this device outside the parameter ranges given above may cause permanent damage.

Recommended Operating Conditions

Parameter	Min	Typ	Max	Units
Supply Voltage (V _{DD})		24		V
Case Temperature	-30		+100	°C
Junction Temperature, T _j			155	°C

Electrical specifications are measured at specified test conditions. Specifications are not guaranteed over all recommended operating conditions.

Typical Performance – Push-Pull Configuration ⁽¹⁾

Test conditions unless otherwise noted: V_{DD}=+24 V, 75 Ω System, Base Temp=+35°C.

Parameter	Conditions	Min	Typ	Max	Units
Operating Frequency		50		1000	MHz
Gain	Tested at 1000 MHz	23	23.5	24.25	dB
Gain Slope	45 to 1003 MHz	0.25		1.5	dB
Gain Flatness	Relative to Slope Line		±0.5	±0.8	dB
Input Return Loss ⁽²⁾			18		dB
Output Return Loss ⁽²⁾			19		dB
CSO	79 channels NTSC 75 channels QAM, -6dB offset, 60 dBmV virtual output, 18dB Tilt		-69	-65	dBc
CTB			-75	-69	dBc
XMOD			-65		dBc
CCN		55	59		dBm
Output IP3	P _{out} = 19 dBm/tone, at 500 MHz Δf = 6 MHz		53		dB
Noise Figure			3.5		dB
Supply Current, I _{DD}		410	445	470	mA
Thermal Resistance, θ _{jc}	Junction to case		5		°C/W

Notes:

1. Includes balun, board, and connector losses.
2. Return losses dependent on balun and transformer selection.

EVB Information – TAT8888 Hybrid Evaluation Board Assembly



SOT-115 Hybrid Module

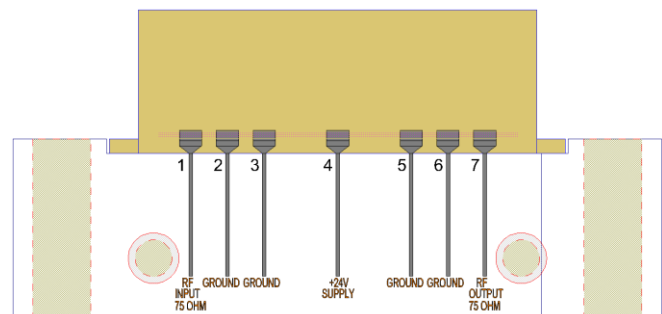

EVB Information – TAT8888 Hybrid Evaluation Board PCB

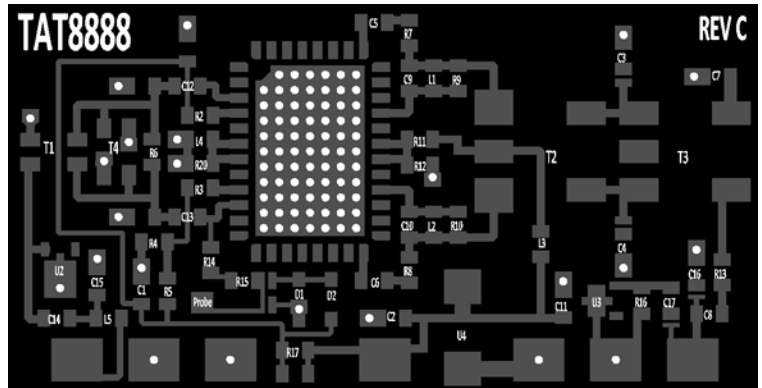
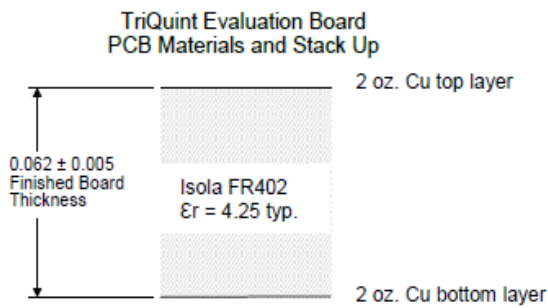

Application Schematic – TAT8888 Hybrid Evaluation Board

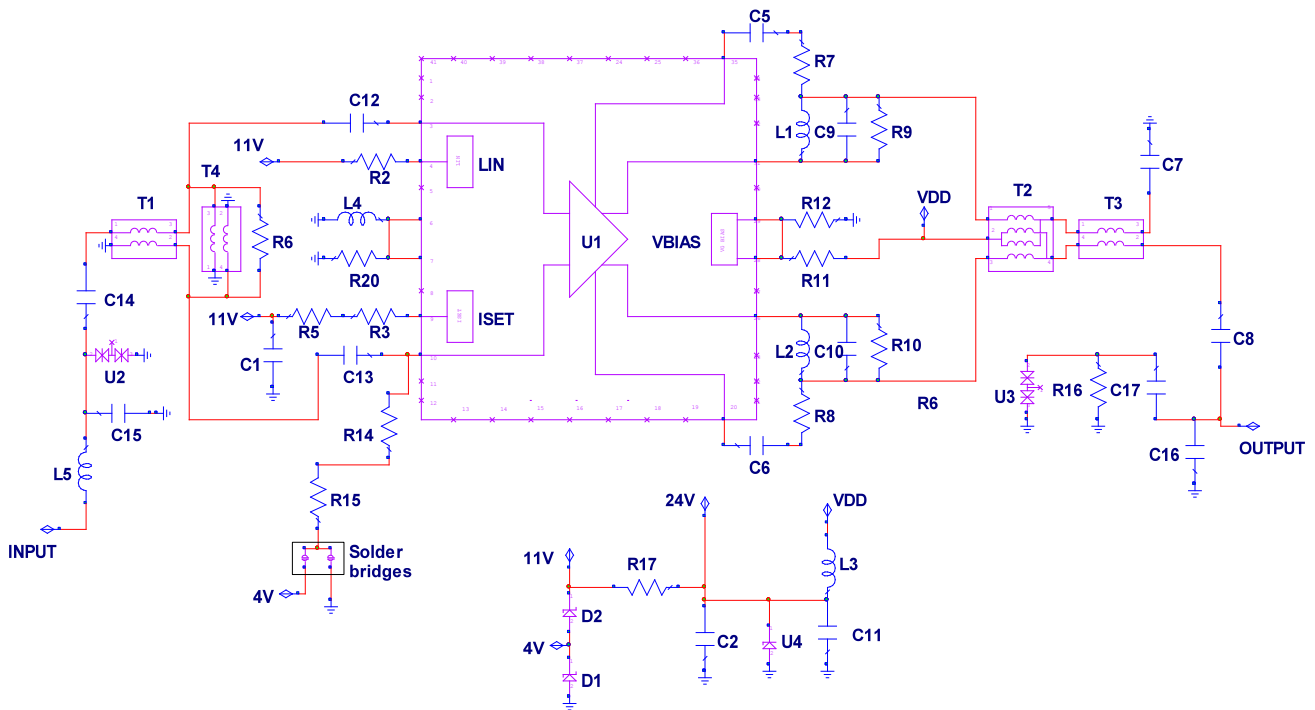

Notes:

1. See Evaluation Board PCB Information section for PCB material and stack-up.
2. Components are 0402 unless specified otherwise.

Bill of Material – TAT8888 Hybrid Evaluation Board

Reference Des.	Value	Description	Manuf.	Part Number
U1		CATV GaN Power Doubler Module	TriQuint	TAT9988
C1, C2, C5, C6, C7, C8, C11, C14, C17	0.01 uF	Cap, Chip, 0402, X7R, 50V, 10%	Various	
C9, C10, C16	0.5 pF	Cap, Chip, 0402, COG, 50V, ± 0.1 pF	Various	
C12, C13	270 pF	Cap, Chip, 0402, NPO, 50V, 5%	Various	
C15	0.3 pF	Cap, Chip, 0402, COG, 50V, ± 0.1 pF	Various	
L1, L2	9.1 nH	Ind, Chip, 0402, 540mA, 5.5GHz, 5%	Murata	LQP15AN9N1J00D
L3, L4	220 Ω	Bead, Chip, 0402, 700mA, 25%	Murata	BLM15EG221SN1D
L5	0 Ω	Res, Chip, 0402, 0.1W, 1%	Various	
R2, R12	2.40 kΩ	Res, Chip, 0402, 0.1W, 1%	Various	
R3	1.60 kΩ	Res, Chip, 0402, 0.1W, 1%	Various	
R5	390 Ω	Res, Chip, 0402, 0.1W, 1%	Various	
R6, R7, R8	1.10 kΩ	Res, Chip, 0402, 0.1W, 1%	Various	
R9, R10	750 Ω	Res, Chip, 0402, 0.1W, 1%	Various	
R11, R14, R16	15.0 kΩ	Res, Chip, 0402, 0.1W, 1%	Various	
R13	0 Ω	Res, Chip, 0402, 0.1W, 1%	Various	
R15	10.0 kΩ	Res, Chip, 0402, 0.1W, 1%	Various	
R17	2.0 kΩ	Res, Chip, 0402, 0.1W, 1%	Various	
R20	10.0 Ω	Res, Chip, 0402, 0.1W, 1%	Various	
T1, T4	1:1	Balun	Murata	DXW21BN7511SL
T2	2.6:1	Transformer	Mintronix	MRF20003
T3	1:1	Balun	Mintronix or MACOM	MRF20001 MABACT0059
U2, U3	N/A	ESD protection , IC	TriQuint	TQP200002
U4	28V	Transient Suppressor, 28V, SOD123W	NXP	PTVS28VS1UR
D1	4.7V	Zener Diode, 4.7V, 2%, SOD523	OnSemi	MM5Z4V7ST1G
D2	6.2V	Zener diode, 6.2V, 2%, SOD523	OnSemi	MM5Z6V2ST1G

Performance Plots – TAT8888 Hybrid Evaluation Board

Test conditions unless otherwise noted: $V_{DD}=+24$ V, 75 Ω System, Base Temp= $+35^{\circ}$ C.

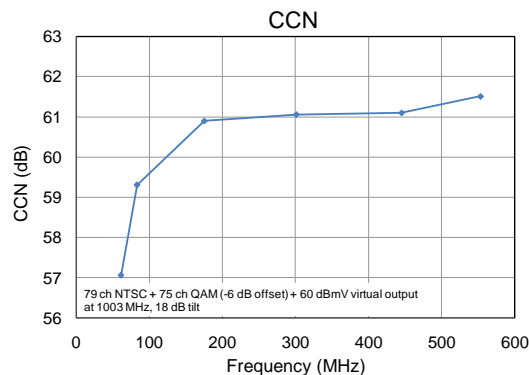
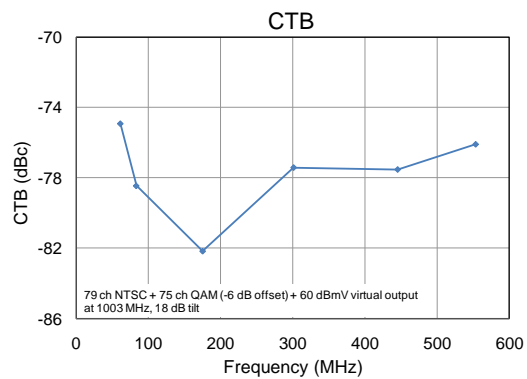
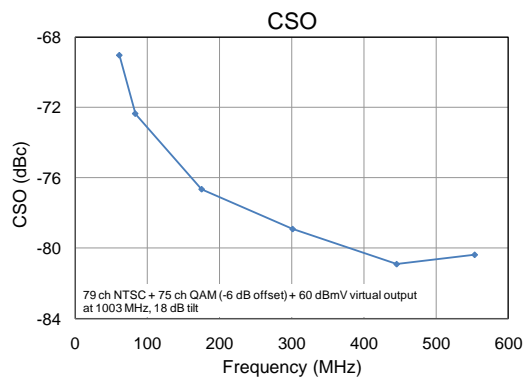
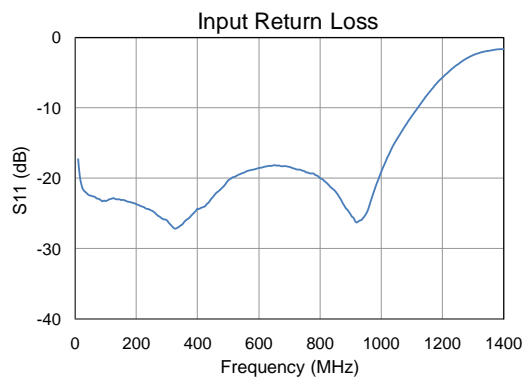
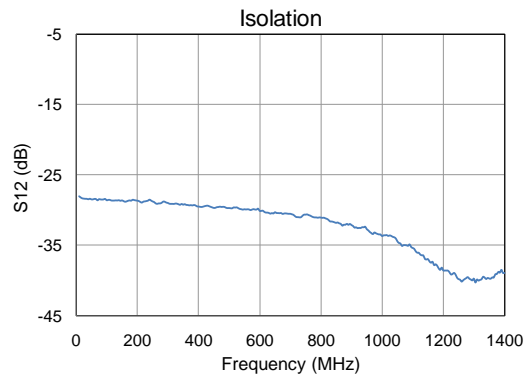
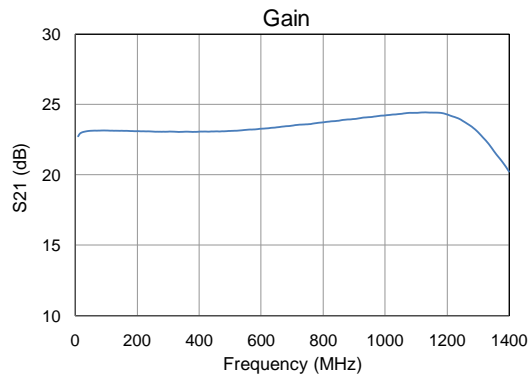

Bill of Material – TAT8888-1200 (50-1200 MHz Hybrid Evaluation Board)

Reference Des.	Value	Description	Manuf.	Part Number
U1		CATV GaN Power Doubler Module	TriQuint	TAT9988
C1, C2, C5, C6, C7, C8, C11, C14, C17	0.01 uF	Cap, Chip, 0402, X7R, 50V, 10%	Various	
C9, C10	0.2 pF	Cap, Chip, 0402, COG, 50V, ± 0.1 pF	Various	
C16	0.5 pF	Cap, Chip, 0402, COG, 50V, ± 0.1 pF	Various	
C12, C13	270 pF	Cap, Chip, 0402, NPO, 50V, 5%	Various	
C15	0.5 pF	Cap, Chip, 0402, COG, 50V, ± 0.1 pF	Various	
L1, L2	9.1 nH	Ind, Chip, 0402, 540mA, 5.5GHz, 5%	Murata	LQP15AN9N1J00D
L3, L4	220 Ω	Bead, Chip, 0402, 700mA, 25%	Murata	BLM15EG221SN1D
L5	8.2 nH	Ind, Chip, 0402, 540mA, 5.5GHz, 5%	Murata	LQP15AN8N2J00D
R2, R12	2.40 kΩ	Res, Chip, 0402, 0.1W, 1%	Various	
R3	1.60 kΩ	Res, Chip, 0402, 0.1W, 1%	Various	
R5	390 Ω	Res, Chip, 0402, 0.1W, 1%	Various	
R6, R7, R8	1.10 kΩ	Res, Chip, 0402, 0.1W, 1%	Various	
R9, R10	750 Ω	Res, Chip, 0402, 0.1W, 1%	Various	
R11, R14, R16	15.0 kΩ	Res, Chip, 0402, 0.1W, 1%	Various	
R13	0 Ω	Res, Chip, 0402, 0.1W, 1%	Various	
R15	10.0 kΩ	Res, Chip, 0402, 0.1W, 1%	Various	
R17	2.0 kΩ	Res, Chip, 0402, 0.1W, 1%	Various	
R20	10.0 Ω	Res, Chip, 0402, 0.1W, 1%	Various	
T1, T4	1:1	Balun	Murata	DXW21BN7511SL
T2	2.6:1	Transformer	Mintronix	MRF20003
T3	1:1	Balun	Mintronix or MACOM	MRF20001 MABACT0059
U2, U3	N/A	ESD protection , IC	TriQuint	TQP200002
U4	28V	Transient Suppressor, 28V, SOD123W	NXP	PTVS28VS1UR
D1	4.7V	Zener Diode, 4.7V, 2%, SOD523	OnSemi	MM5Z4V7ST1G
D2	6.2V	Zener diode, 6.2V, 2%, SOD523	OnSemi	MM5Z6V2ST1G

Performance Plots – TAT8888-1200 (50-1200 MHz Hybrid Evaluation Board)

Test conditions unless otherwise noted: $V_{DD}=+24$ V, 75 Ω System, Base Temp= $+35^{\circ}\text{C}$.

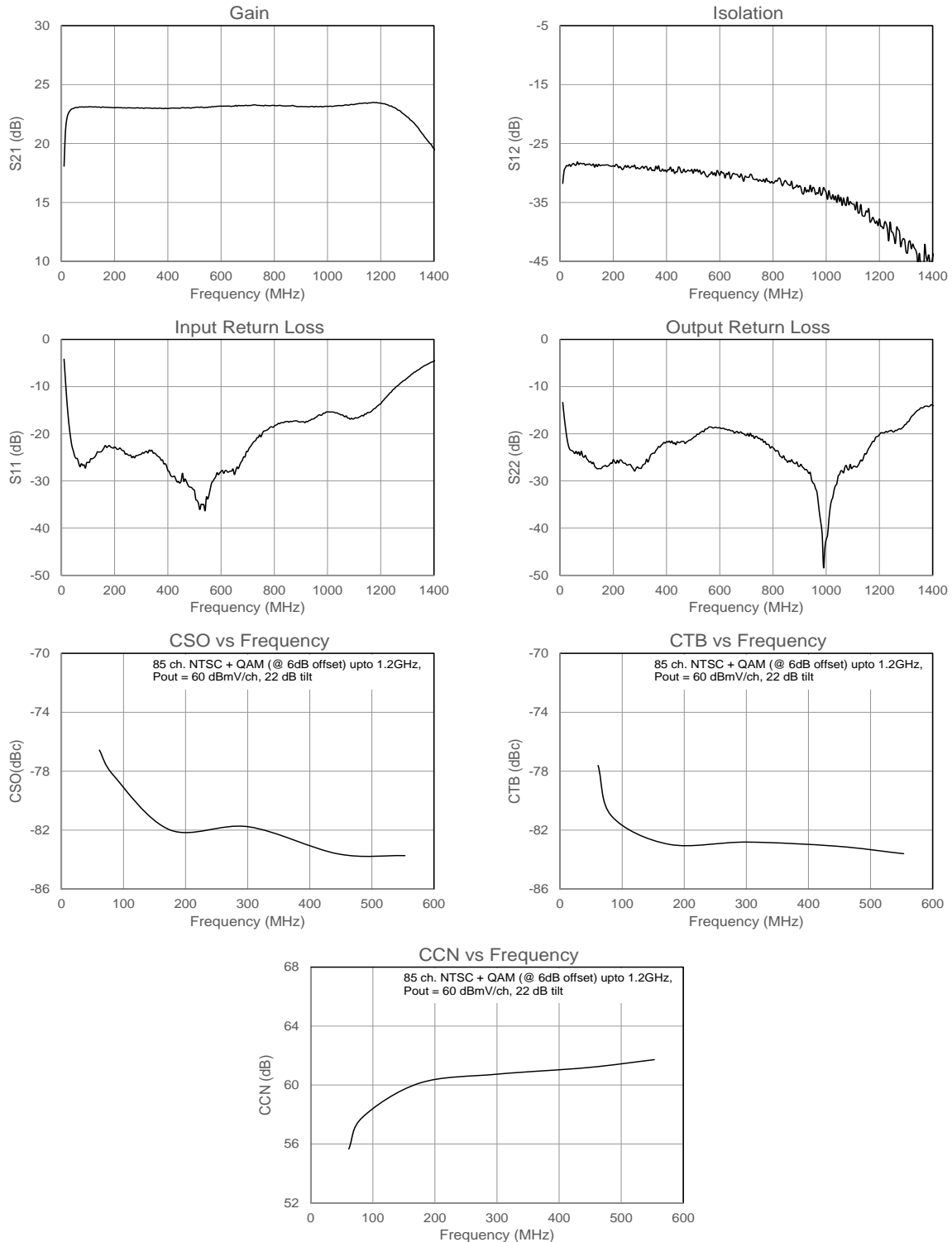

Pin Configuration and Description

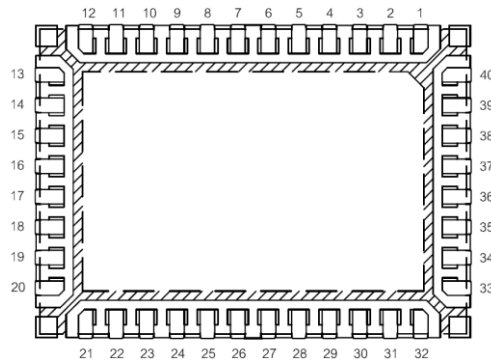

Pin No.	Function	Description
3	Non-Inverting Amplifier Input	Requires AC coupling from input balun
4	Linearizer Current-Adjust	Connect to VDD through resistors R4 and R8
6,7	Common Source Node	DC GND. DC resistance to be minimized from this node to GND.
9	Amplifier Current-Adjust	Connect to VDD through resistor R3.
10	Inverting Amplifier Input	Requires AC coupling from input balun
20	Feedback to Inverting Input	Connects to non-inverting output (Pin 24). Path is layout sensitive and should be kept as short as possible.
24	Non-Inverting Amplifier Output	RF choke required to VDD through output transformer center tap.
26	Output Device Gate Bias 1	Set to 3.25V using resistive divider network between VDD and GND.
27	Output Device Gate Bias 2	Set to 3.25V using resistive divider network between VDD and GND.
29	Inverting Amplifier Output	RF choke required to VDD through output transformer center tap.
33	Feedback to Non-Inverting Input	Connects to inverting output (Pin 29). Path is layout sensitive and should be kept as short as possible.
Backside Paddle	RF/DC GND	Very low DC, RF and thermal resistance required from this node to the heatsink. Recommended via pattern should be followed to minimize thermal resistance.

Package Marking and Dimensions

- Marking: Line 1: TriQuint Logo –
 Line 2: TAT9988 = Product code
 Line 3: YYWW CCCC = Date code, country code
 Line 4: AaXXXX = Aa = vendor code, Lot #

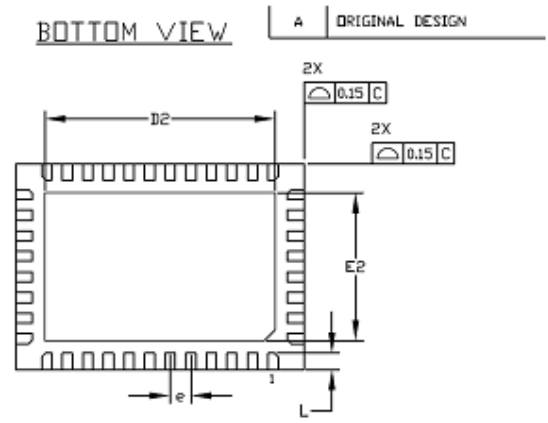
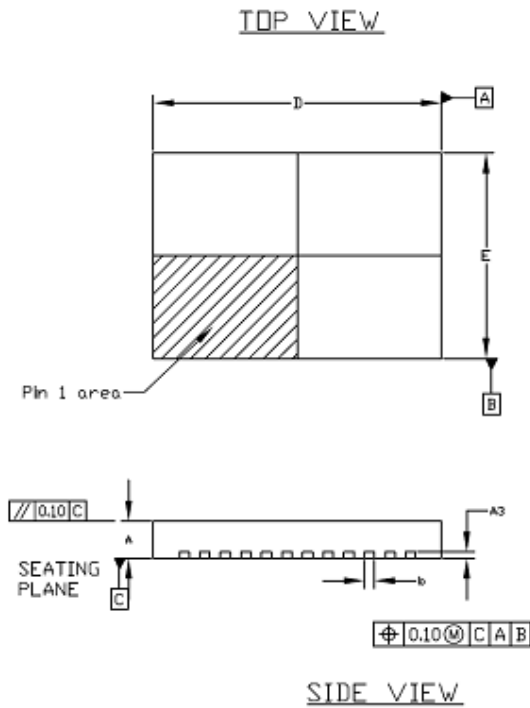

SYMBOL	COMMON					
	DIMENSIONS MILLIMETER			DIMENSIONS INCH		
	MIN.	NOM.	MAX.	MIN.	NOM.	MAX.
A	0.85	0.90	0.95	0.034	0.036	0.038
A3	0.203 REF			0.008 REF		
b	0.20	0.25	0.30	0.008	0.010	0.012
D	6.85	7.00	7.15	0.269	0.275	0.281
D2	5.50	5.60	5.70	0.216	0.220	0.224
E	4.85	5.00	5.15	0.190	0.196	0.202
E2	3.50	3.60	3.70	0.137	0.141	0.145
e	0.50 REF			0.020 REF		
L	0.30	0.40	0.50	0.012	0.016	0.020

Recommended Reflow Solder Profile

The following solder reflow profile is for a typical SAC305 no-lead solder paste application and assumes that industry standard PCB layout rules have been followed. Solder paste manufacturers will recommend a "typical" solder reflow profile depending on their particular solder paste's flux and metal composition. PCB size & composition, component density & position and reflow equipment are some of the factors that will impact and dictate the optimum reflow profile in specific manufacturing scenarios.

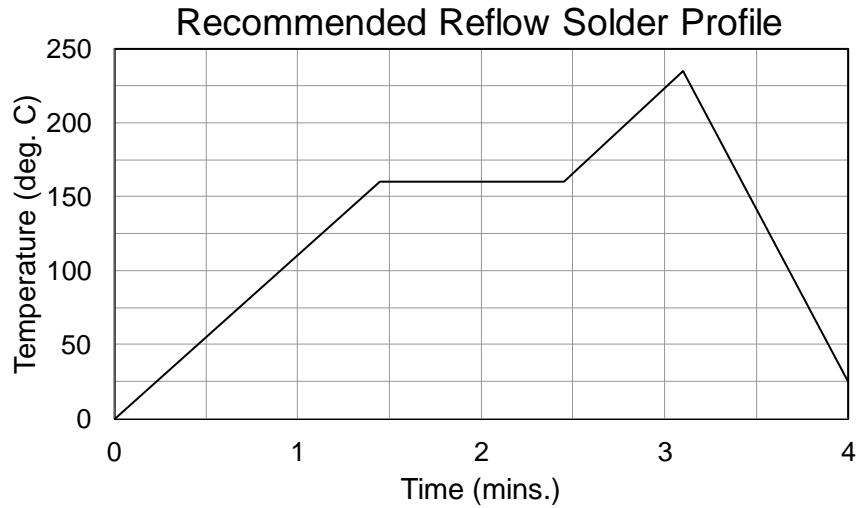

Product Compliance Information

ESD Sensitivity Ratings



Caution! ESD-Sensitive Device

ESD Rating: Class 0
Value: <250 Volts
Test: Human Body Model (HBM)
Standard: JEDEC Standard JESD22-C101

ESD Rating: Class III
Value: 500 to 1000 Volts
Test: Charged Device Model (CDM)
Standard: JEDEC Standard JESD22-C101

MSL Rating

MSL Rating: Level 3
Test: 260°C convection reflow
Standard: JEDEC Standard IPC/JEDEC J-STD-020

Solderability

Compatible with both lead-free (260°C maximum reflow temperature) and tin/lead (245°C maximum reflow temperature) soldering processes.

Contact plating: NiPdAu

RoHs Compliance

This part is compliant with EU 2002/95/EC RoHS directive (Restrictions on the Use of Certain Hazardous Substances in Electrical and Electronic Equipment).

This product also has the following attributes:

- Lead Free
- Halogen Free (Chlorine, Bromine)
- Antimony Free
- TBBP-A (C₁₅H₁₂Br₄O₂) Free
- PFOS Free
- SVHC Free

Contact Information

For the latest specifications, additional product information, worldwide sales and distribution locations, and information about TriQuint:

Web: www.triquint.com
Email: info-sales@tqs.com

Tel: +1.503.615.9000
Fax: +1.503.615.8902

For technical questions and application information: Email: sjapplications.engineering@tqs.com

Important Notice

The information contained herein is believed to be reliable. TriQuint makes no warranties regarding the information contained herein. TriQuint assumes no responsibility or liability whatsoever for any of the information contained herein. TriQuint assumes no responsibility or liability whatsoever for the use of the information contained herein. The information contained herein is provided "AS IS, WHERE IS" and with all faults, and the entire risk associated with such information is entirely with the user. All information contained herein is subject to change without notice. Customers should obtain and verify the latest relevant information before placing orders for TriQuint products. The information contained herein or any use of such information does not grant, explicitly or implicitly, to any party any patent rights, licenses, or any other intellectual property rights, whether with regard to such information itself or anything described by such information.

TriQuint products are not warranted or authorized for use as critical components in medical, life-saving, or life-sustaining applications, or other applications where a failure would reasonably be expected to cause severe personal injury or death.