

## Spec Sheet

High-Q Multilayer Chip Inductors for High Frequency Applications (HK series Q type / AQ series)

# HKQ0603W3N0C-T

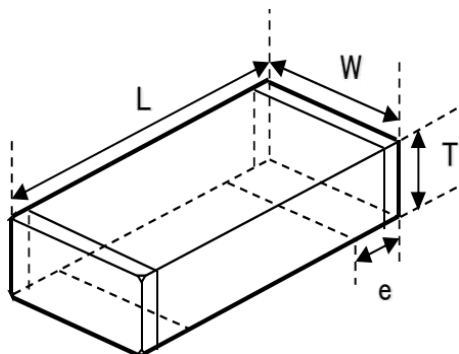

### ■ Features

- Item Summary  
3.0nH(-0.2nH to +0.2nH), 500mA, 15, 0201
- Lifecycle Stage  
Mass Production
- Standard packaging quantity (minimum)  
Taping 15000pcs

### ■ Products characteristics table

CaseSize (EIA/JIS)	0201/0603
Inductance	3.0nH(-0.2nH to +0.2nH)
Inductance Measuring Frequency	500MHz
Rated Current	500mA -
DC Resistance (max)	0.2Ω
Self-resonant Frequency (min)	8500MHz
Q (max)	15min
Q Measuring Frequency	500MHz
RoHS Compliance	Yes
Halogen Free	Yes
Soldering Method	Reflow

### ■ External Dimensions

L	0.6mm ±0.03
W	0.3mm ±0.03
H	0.3mm ±0.03
e	0.15mm ±0.05

2015.04.13

The data is reference only. Electrical characteristics vary depending on environment or measurement condition.  
TAIYO YUDEN reserves the right to make change to the Date at any time without notice.  
Before making final selection, please check product specification.