

Silicon NPN Power Transistors

2SC3336

DESCRIPTION

- With TO-3P(I) package
- High voltage,high speed

APPLICATIONS

- For high voltage ; high speed and high power switching applications

PINNING

PIN	DESCRIPTION
1	Base
2	Collector;connected to mounting base
3	Emitter

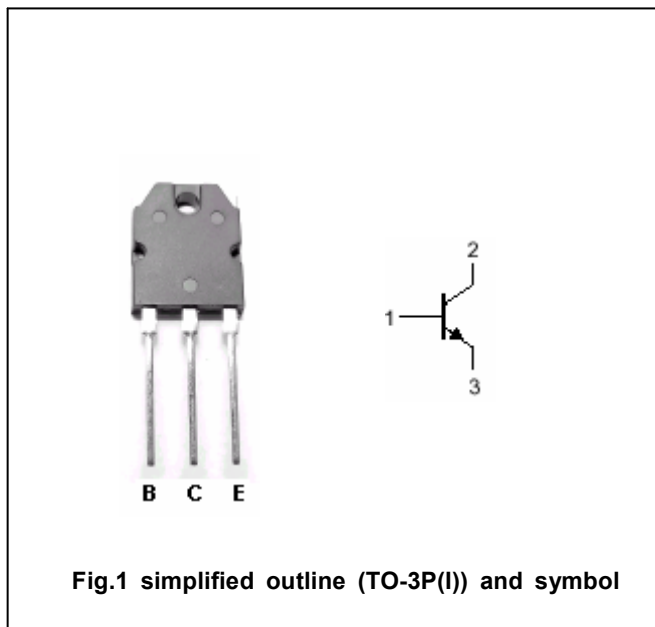

Absolute maximum ratings(Ta=25°C)

SYMBOL	PARAMETER	CONDITIONS	VALUE	UNIT
V _{CBO}	Collector-base voltage	Open emitter	500	V
V _{CEO}	Collector-emitter voltage	Open base	400	V
V _{EBO}	Emitter-base voltage	Open collector	10	V
I _C	Collector current		15	A
I _{CM}	Collector current-peak		25	A
I _B	Base current		7.5	A
P _T	Total power dissipation	T _C =25°C	100	W
T _j	Junction temperature		150	°C
T _{stg}	Storage temperature		-55~150	°C

Silicon NPN Power Transistors

2SC3336

CHARACTERISTICS

T_j=25 °C unless otherwise specified

SYMBOL	PARAMETER	CONDITIONS	MIN	TYP.	MAX	UNIT
V _{CEO(SUS)}	Collector-emitter sustaining voltage	I _C =0.2A, R _{BE} =∞; L=100mH	400			V
V _{(BR)EBO}	Emitter-base breakdown voltage	I _E =10mA; I _C =0	10			V
V _{CEsat}	Collector-emitter saturation voltage	I _C =7.5A; I _B =1.5A			1.0	V
V _{BE sat}	Base-emitter saturation voltage	I _C =7.5A; I _B =1.5A			1.5	V
I _{CBO}	Collector cut-off current	V _{CB} =400V; I _E =0			50	μA
I _{CEO}	Collector cut-off current	V _{CE} =350V; R _{BE} =∞			50	μA
h _{FE-1}	DC current gain	I _C =7.5A; V _{CE} =5V	12			
h _{FE-2}	DC current gain	I _C =15A; V _{CE} =5V	5			

Switching times

t _{on}	Turn-on time	I _C =15A; V _{CC} =150V I _B =-I _B =3.0A			0.5	μs
t _{stg}	Storage time				1.5	μs
t _f	Fall time				0.5	μs

Silicon NPN Power Transistors

2SC3336

PACKAGE OUTLINE

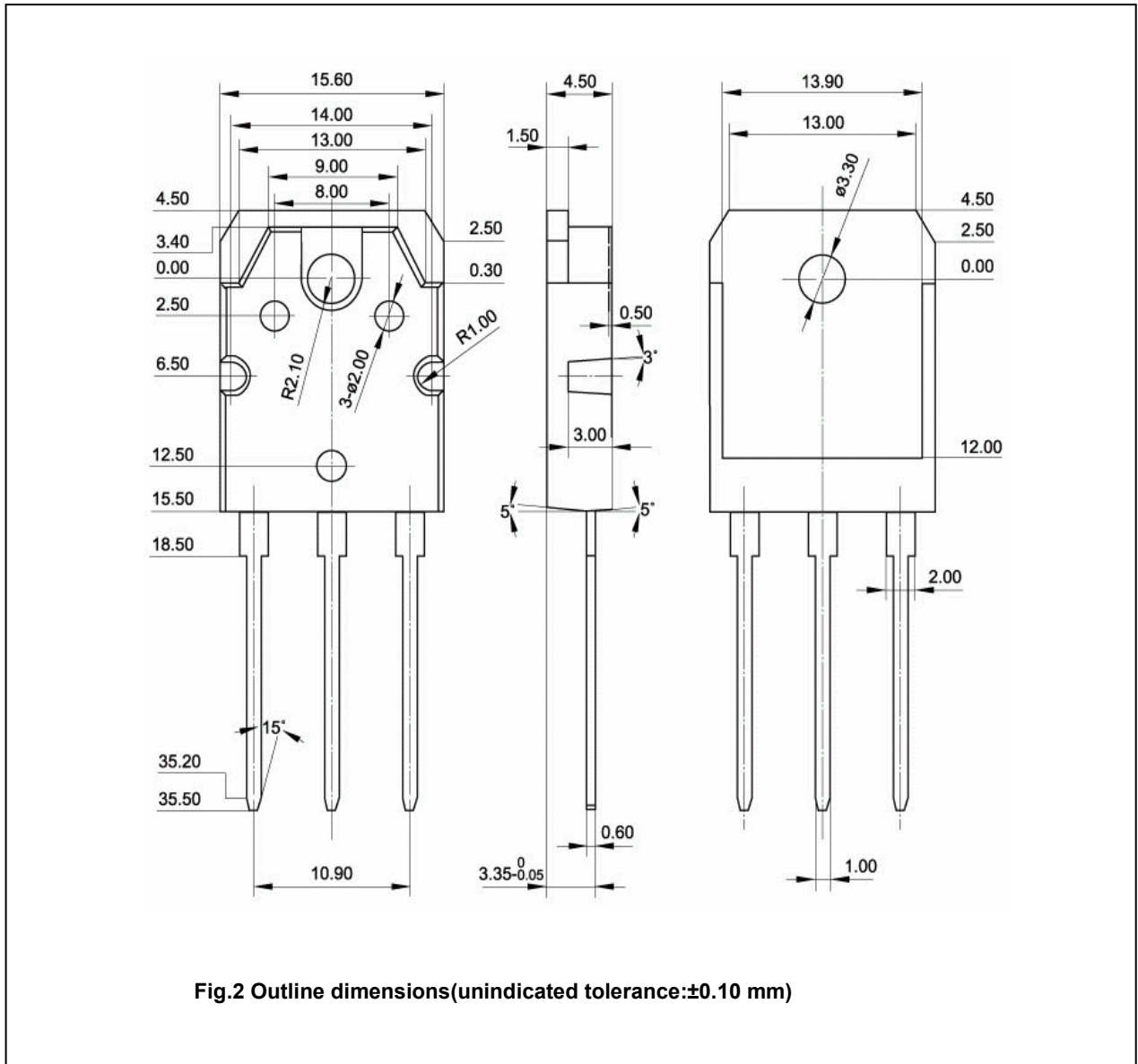

Fig.2 Outline dimensions(unindicated tolerance: ± 0.10 mm)

Silicon NPN Power Transistors

2SC3336

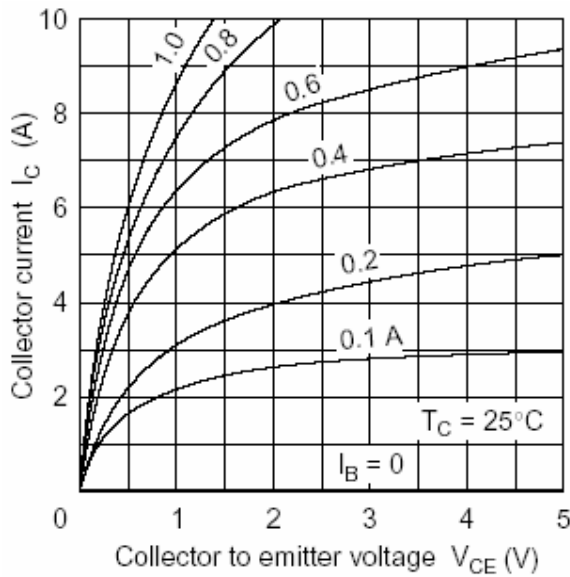

Fig.3 Static Characteristic

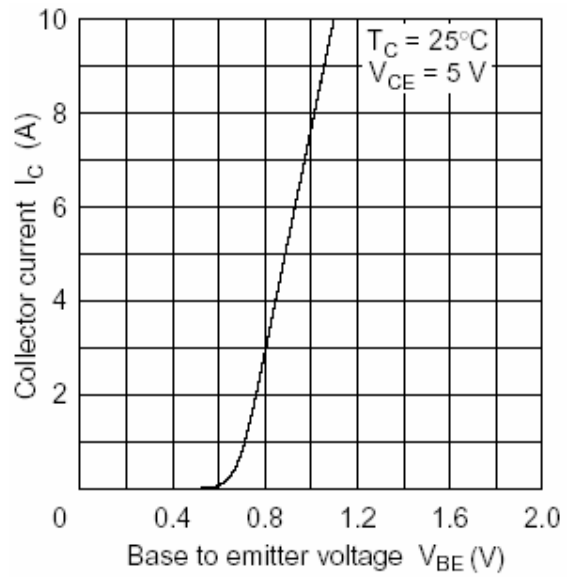

Fig.4 $I_C - V_{BE}$

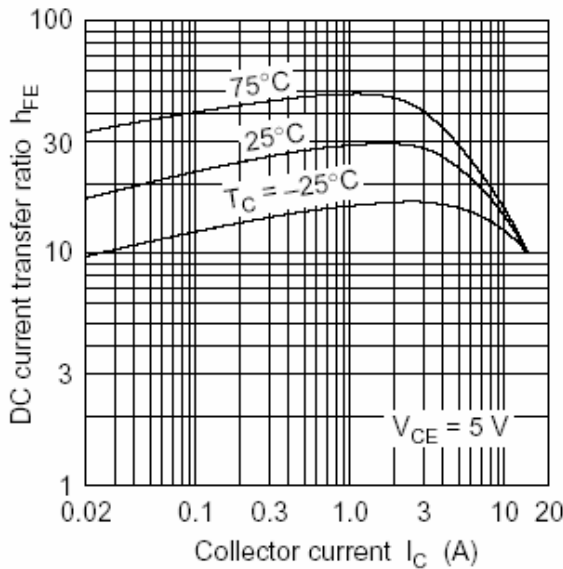

Fig.5 DC current Gain

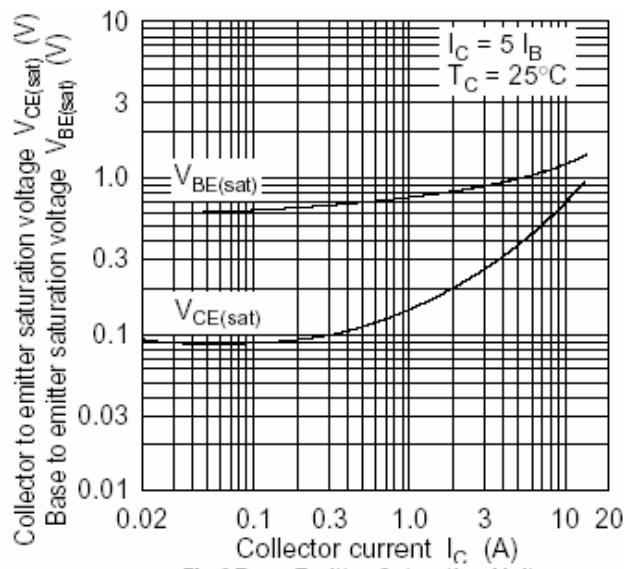

Fig.6 Base-Emitter Saturation Voltage
Collector-Emitter Saturation Voltage

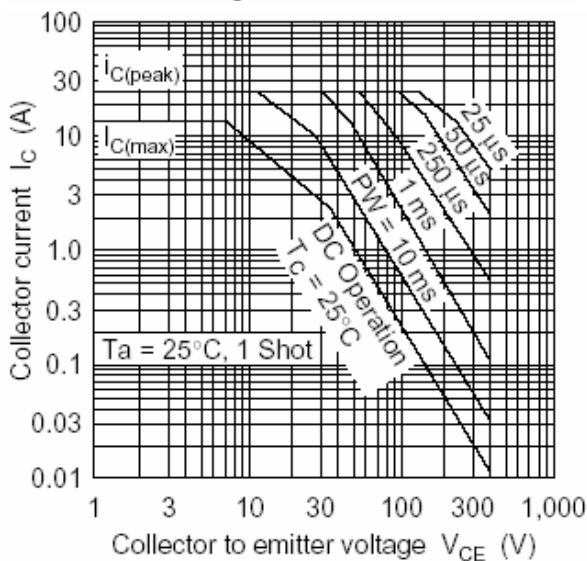

Fig.7 Safe Operating Area