



IQS253 Datasheet - Configurable 3 Channel DYCAL™ Capacitive Sensor with Automatic Compensation for Sensitivity Reducing Objects

Unparalleled Features:

- DYCAL™: Intelligent Hysteresis
- Internal Capacitor Implementation (ICI) - Reference capacitor on-chip
- Automatic Tuning Implementation (ATI) - Automatic adjustment for optimal sensor performance

The IQS253 ProxSense[®] IC is a fully integrated capacitive sensor implementing Dynamic Calibration (DYCAL™) technology: intelligent hysteresis to allow for sensor drift even during sensor activation.

Main features:

- Self or Projected Technology sensors
- 3 Channels configurable as DYCAL™ /Normal output
- Self: Boolean direct output configurable through I²C
- Supply voltage: 1.8 V to 3.6 V
- Internal voltage regulator
- Advanced on-chip digital signal processing
- I²C adjustable settings
 - DYCAL™ settings
 - Control over filter operation
 - Time-out for stuck key
 - Proximity and Touch sensitivity selections
 - Low Power options
 - Event Mode possible (only communicates if an event is detected)

Applications:

- Occupancy sensors
- SAR compliant sensors for Tablet PC's
- On-ear detection for mobile phones
- 3D glasses
- Personal Media Players
- Remote Control Sleep implementation
- Gaming Controllers
- Proximity activated backlighting

- Any applications where a touch and proximity condition can exist for a extended period of time

Advantages:

- Allows for sensor drift in periods of activation and non-activation
- Improved digital filtering to reduce external noise
- Highly adjustable I²C device which only interrupts (Event Mode) when an event is detected

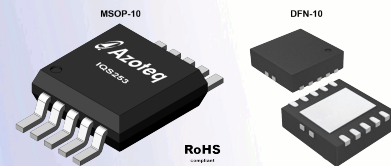



Contents

List of Figures	4
List of Tables	4
Revision History	4
List of Symbols	5
1 Functional Overview	6
1.1 Applicability	6
2 Analogue Functionality	6
3 Digital Functionality	7
4 Packaging and Pin-Out	8
4.1 IQS253 Self Capacitance	8
4.2 IQS253 Projected	9
4.3 Power Supply and PCB Layout	10
4.4 Design Rules for Harsh EMC Environments	11
5 DYCAL	12
5.1 Operating Principle	13
6 ProxSense Module	14
6.1 Charge Transfer Concepts	14
7 Prox Module Setup	14
7.1 Self or Projected Capacitance	14
7.2 Rate of Charge Cycles	15
7.3 Report Rate	16
7.4 Active Channels	16
7.5 DYCAL™ or Direct Output	16
7.6 Report Order (Channel Numbers)	16
7.7 Transfer Frequency (f_{cx})	16
7.8 Counts	16
7.9 Long Term Average (LTA)	16
7.10 Determine Touch or Prox	18
7.11 ATI	18
8 DYCAL™	19
8.1 DYCAL™ channels enable	20
8.2 DYCAL™ on TOUCH/PROX	20
8.3 LTA Adapt rates (IN and OUT)	20
8.4 Block Channel	20
8.5 DYCAL™ Release Threshold	20
8.6 DYCAL™ dynamic touch threshold	20
8.7 10s_ATI_BLOCK	20
8.8 250ms_DELAY_TM (t_{DYCAL})	21
8.9 Turbo Mode	21



9	Communication	22
9.1	IC Setup Window	22
9.2	Event Mode	22
9.3	I ² C Specific Commands	22
9.4	I ² C Read and Write specifics	22
10	Boolean Output	24
10.1	Channels for Boolean operation	24
10.2	Boolean NOT	24
10.3	Boolean AND/OR	24
10.4	Order of Boolean operation:	24
11	RF Noise	24
11.1	Noise Immunity	24
12	Electrical Specifications	26
12.1	General Characteristics (Measured at 25 °C)	26
12.2	Timing Characteristics	27
13	Mechanical Dimensions	29
14	Device Marking	31
15	Ordering Information	31
16	Device Revision History	32
17	Errata	32
18	Contact Information	33
A	Appendix A	34
B	Appendix B	36
B.1	IQS253 Memory Map	36
B.2	General Implementation Hints	52
B.3	Startup Procedure	52
B.4	General I ² C Hints	52
	References	53

List of Figures

4.1	IQS253 Pin Out.	8
4.2	Self Reference Design.	9
4.3	Projected Reference Design.	10
4.4	EMC Design Choices.	11
5.1	DYCAL Overview.	12
7.1	Boost power as on CX/CRXx.	15
7.2	Charge cycles as charged in LP modes.	15
9.1	IC Setup Window.	22
13.1	MSOP10 Package	29
13.2	MSOP10 Footprint.	29
13.3	MSOP10 Silk Screen.	29



13.4 DFN-10 Package.	29
13.5 DFN Side View.	30
13.6 DFN Footprint.	30
A.1 DYCAL output selected on proximity.	34
A.2 DYCAL output selected on touch.	34
A.3 Filter halt upon Touch Mode Entry.	35

List of Tables

4.1 IQS253 Self Capacitive Pin-out	8
4.2 IQS253 Projected Capacitive Pin-out	9
7.1 LTA halting in non-TM.	18
12.1 IQS253 General Operating Conditions - Projected Capacitive Sensor.	26
12.2 IQS253 General Operating Conditions - Self Capacitive Sensor.	26
12.3 Start-up and shut-down slope Characteristics	27
12.4 Debounce employed on IQS253.	27
12.5 General Timing Characteristics for $1.80V \leq VDDHI \leq 3.60V$	27
12.6 IQS253 charging times	28
12.7 IQS253 DYCAL (OUTPUT_ON_TOUCH = 0) /Proximity Response Times	28
13.1 MSOP10 Package Dimensions.	29
13.2 MSOP-10 Footprint Dimensions	29
13.3 MSOP-10 Silk Screen Dimensions	29
13.4 DFN-10 Package Dimensions.	30
13.5 DFN-10 Side View Dimensions.	30
13.6 DFN-10 Footprint Dimensions	30

Revision History

Rev	Description	Date
1.0.1	Preliminary	Sept 2011
1.00	First Release	Jan 2012
1.01	Update HC description	March 2012
1.02	Update DFN-10 Footprint	April 2012
1.03	Include the Memory Map in the Datasheet	April 2012
1.04	Update Self Reference Schematic with pull-up on Boolean Output	June 2012



List of Symbols

ATI	Automatic Tuning Implementation	6
BP	Boost Power Mode	15
CS	Count(s)	13
CX	Sensor Electrode	8
EMI	Electromagnetic Interference	10
ESD	Electro-Static Discharge	10
FTB/EFT	(Electrical) Fast Transient Bursts	10
GND	Ground	8
HC	Halt Charge	15
LP	Low Power Mode	15
LTA	Long Term Average	13
ND	Noise Detect	8
NTM	Non Touch Mode	13
P	Proximity	13
RDY	Ready	8
SCL	I ² C Clock	8
SDA	I ² C Data	8
t	Time	15
T	Touch	13
THR	Threshold	13
TM	Touch Mode	6
TVS	Transient Voltage Suppression diode - ESD protection	6
VDDHI	Supply (input) Voltage	6
VREG	Internal Regulator Output	8
WDT	Watch-dog Timer	6



1 Functional Overview

The IQS253 is a fully integrated three channel capacitive sensor implementing the DYCAL™ functionality. Dynamic Calibration (DYCAL™) is an intelligent hysteresis to allow for sensor drift even during sensor activation. All channels can be either configured as a DYCAL™ channel or as a normal direct output channel. The device has an internal voltage regulator and reference capacitor. The regulator is used as reference for the charge transfer circuitry. Both circuits reduce the external component count needed. The device automatically tracks slow varying environmental changes via various signal processing algorithms and has an Automatic Tuning (ATI) algorithm to calibrate the device to the sense electrode. The charge transfer method of capacitive sensing is employed on the IQS253. (The charge transfer principle is thoroughly described in the application note: "AZD004 - Azoteq Capacitive Sensing".) The IQS253 can be configured as either a self capacitance sensor, where it has a Boolean output pin available. With the sensor configured as a projected capacitance sensor, this pin is configured as the transmitter electrode. DYCAL™ settings are highly configurable via I²C. These settings include:

- DYCAL™ activation with either Touch or Proximity detection
- Release threshold
- Touch mode (TM) entry speed
- Downward filter adaptation rate when in TM
- Upward filter adaptation rate when in TM
- ATI block after exiting activation
- Boolean output configuration

The above mentioned configuration settings do not include regular ProxSense® settings adjustable via I²C. Regular settings include:

- Proximity / Touch Thresholds
- Power Modes
- Adaptation rate when not in TM

- Noise detection activation
- ATI setup (control over sensitivity and when ATI should occur)
- Redo ATI
- Control over the LTA filters
- WDT enable / disable
- AC Filter enable / disable
- Proximity debounce
- Charge transfer frequency
- Block channel
- Event mode enable / disable
- Setup to wake communication with a particular event

1.1 Applicability

All specifications, except where specifically mentioned otherwise, provided by this datasheet are applicable to the following ranges:

- Temperature –40 °C to +85 °C
- Supply voltage (VDDHI) 1.8 V to 3.3 V

2 Analogue Functionality

The analogue circuitry measures the capacitance of the sense electrodes attached to the Cx pins through a charge transfer process that is periodically initiated by the digital circuitry. The measuring process is referred to as a conversion and consists of the discharging of Cs and Cx, the charging of Cx and then a series of charge transfers from Cx to Cs until a trip voltage is reached. The number of charge transfers required to reach the trip voltage is referred to as counts (Cs). The capacitance measurement circuitry makes use of an internal reference capacitor and voltage reference (VREG). The analogue circuitry further provides functionality for:



- Power on reset (POR) detection.
- Brown out detection (BOD).

3 Digital Functionality

The digital processing functionality is responsible for:

- Management of BOD and WDT events.
- Initiation of conversions at the selected rate.
- Processing of CS and execution of algorithms.
- Monitoring and automatic execution of the ATI algorithm.
- Signal processing and digital filtering.
- Detection of PROX and TOUCH events.
- Managing outputs of the device.
- Managing serial communications.
- Manage programming of OTP options.



4 Packaging and Pin-Out

The IQS253 IC is available in the MSOP-10 and DFN-10 package. The pin-outs of the self and projected setup differ with the transmitter (CTX) on the projected configuration being configured as a Boolean output (B_OUT) on the self configuration.

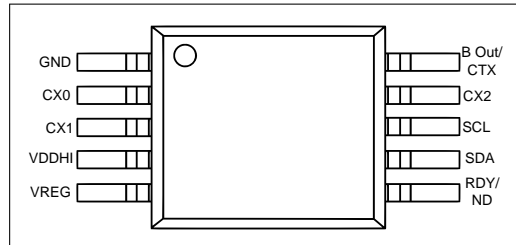

Figure 4.1: IQS253 Pin Out.

4.1 IQS253 Self Capacitance

4.1.1 Pin-out

Table 4.1: IQS253 Self Capacitive Pin-out

Pin	Name	Type	Function
1	GND	Supply Input	Ground Reference
2	CX0	Analogue	Sense Electrode 0
3	CX1	Analogue	Sense Electrode 1
4	VDDHI	Supply Input	Supply Voltage Input
5	VREG	Analogue Output	Internal Regulator Pin (Connect 1 μ F bypass capacitor)
6	RDY/ND	Digital Out / Analogue In	I ² C: RDY Data indication Output / ND pin
7	SDA	Digital I/O	I ² C: Data Input / Output
8	SCL	Digital Input	I ² C: Clock Input
9	CX2	Analogue	Sense Electrode 2
10	B_OUT	Digital Output	Boolean Output (Open Drain - Requires pull-up resistor)



4.1.2 Schematic

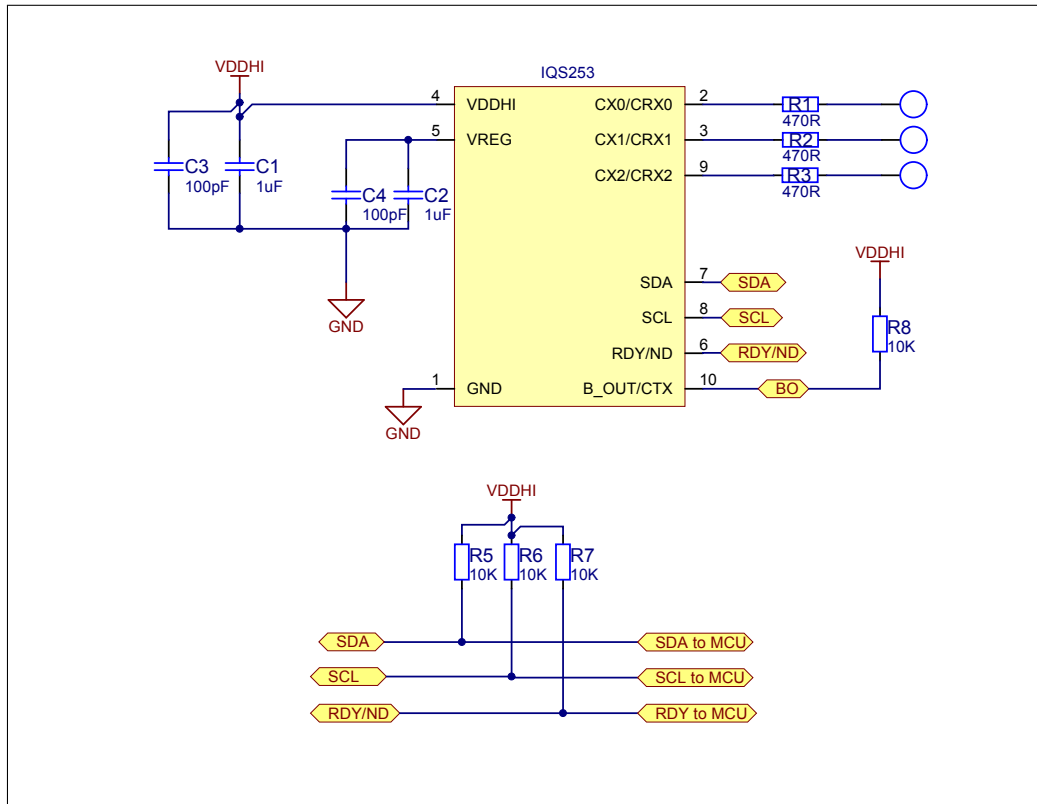

Figure 4.2: Typical application schematic of IQS253 self capacitive configuration.

4.2 IQS253 Projected

Table 4.2: IQS253 Projected Capacitive Pin-out

Pin	Name	Type	Function
1	GND	Supply Input	Ground Reference
2	CX0	Analogue	Projected Charge Receiver 0
3	CX1	Analogue	Projected Charge Receiver 1
4	VDDHI	Supply Input	Supply Voltage Input
5	VREG	Analogue Output	Internal Regulator Pin (Connect 1 μ F bypass capacitor)
6	RDY/ND	Digital Out / Analogue In	I ² C: RDY Data indication Output / ND pin
7	SDA	Digital I/O	I ² C: Data Input / Output
8	SCL	Digital Input	I ² C: Clock Input
9	CX2	Analogue	Projected Charge Receiver 2
10	CTX	Analogue	Charge Transmitter

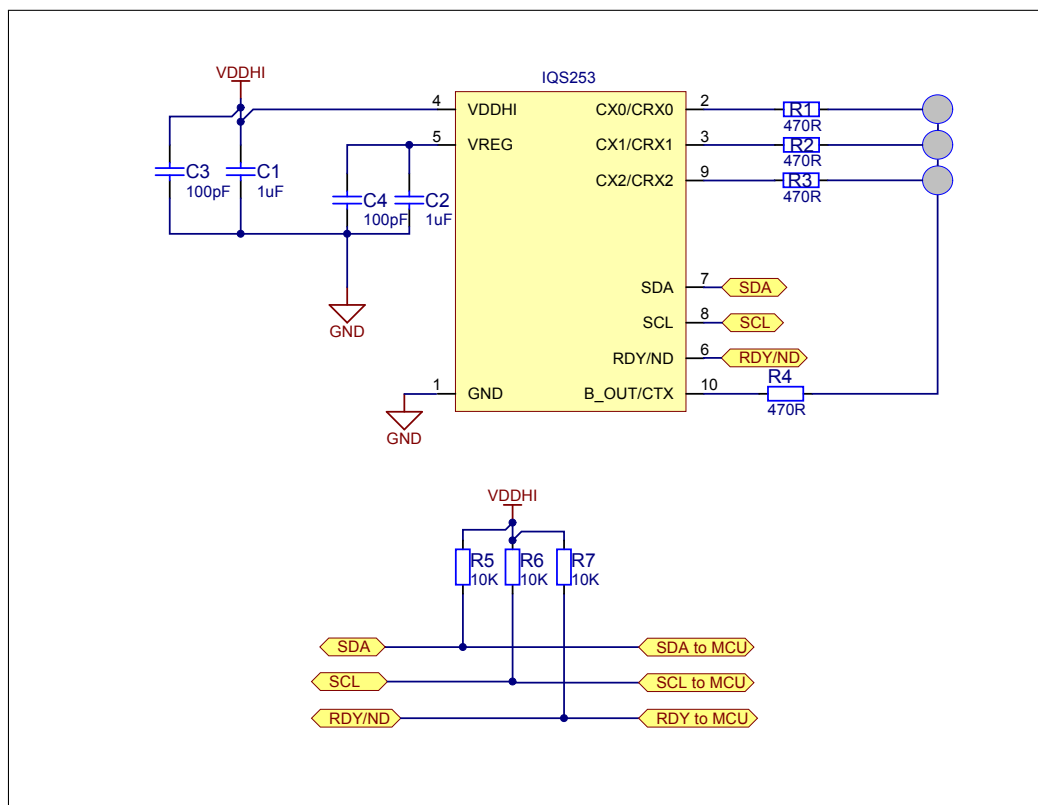

Figure 4.3: Typical application schematic of IQS253 projected capacitive configuration. Refer to the application note for layout guideline [1]

4.3 Power Supply and PCB Layout

Azoteq IC's provide a high level of on-chip hardware and software noise filtering and ESD protection (refer to Section 12). Designing PCB's with better noise immunity against EMI, FTB and ESD in mind, it is always advisable to keep the critical noise suppression components like the de-coupling capacitors and series resistors in Figure 4.2 as close as possible to the IC. Always maintain a good ground connection and ground pour underneath the IC. For more guidelines please refer to the relevant application notes as mentioned in Section 4.4.



4.4 Design Rules for Harsh EMC Environments

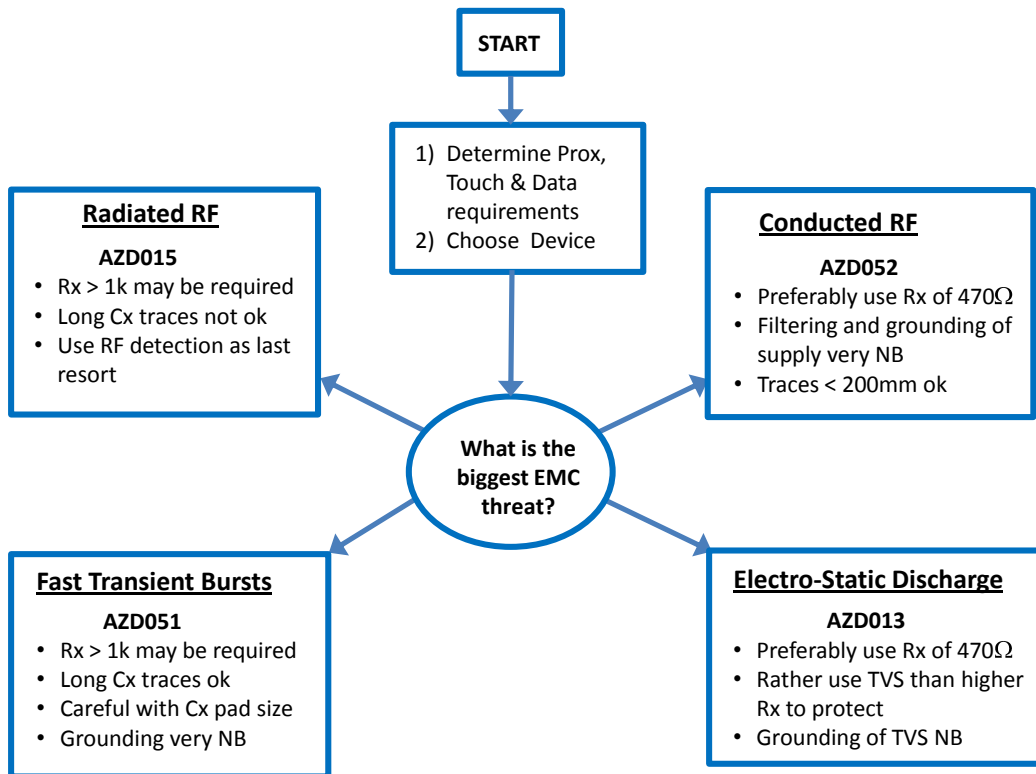

Figure 4.4: EMC Design Choices. Applicable application notes: [2], [3], [4], [5]

5 DYCAL

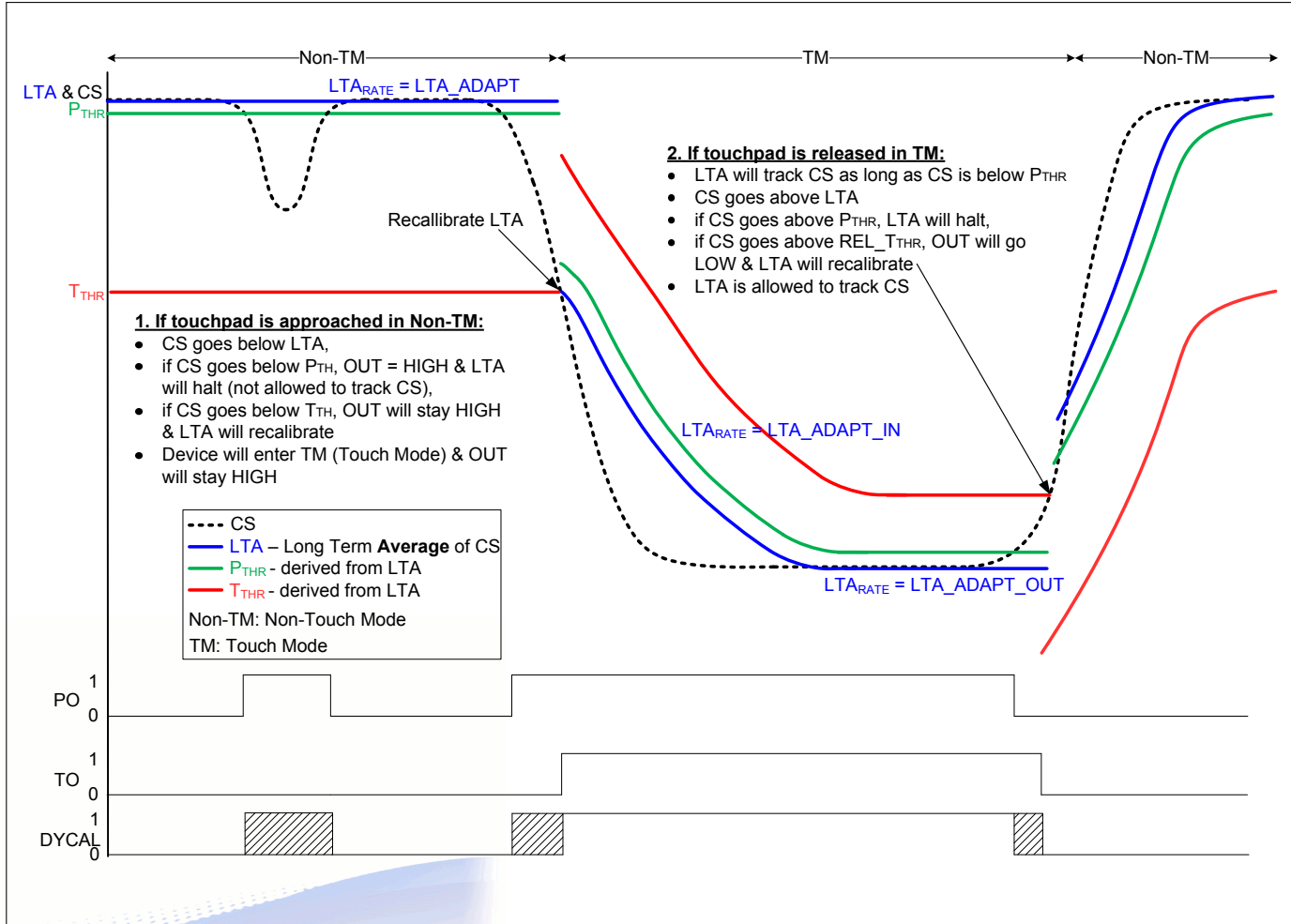

Figure 5.1: DYCAL Overview.



5.1 Operating Principle

Figure 5.1 is a visual representation of the DYCAL™ functionality. The DYCAL output is used to indicate the status of a DYCAL™ event (both a proximity and a touch event). The DYCAL™ functionality is summarised below.

Non-Touch Mode

The DYCAL output is activated on the successful detection of a proximity event and will remain activated for the duration of the proximity event, permitting that this event is not longer than the filter halt timings. The LTA will be halted in this time. As soon as a touch condition is detected (CS below T_{THR}), the controller will dynamically re-calibrate its LTA to the halted LTA - T_{THR} . The IC is now in Touch Mode (TM).

Touch Mode

After the re-calibration of the LTA, it will follow the CS and be allowed to track slow varying environmental changes. If the CS were to exceed the LTA by a release threshold (REL_T_{THR}) the touch detection will stop and the DYCAL output will return to its original state.



6 ProxSense Module

The IQS253 contains a ProxSense® module that uses patented technology to provide detection of PROX/TOUCH on numerous sensing lines. The ProxSense® module is a combination of hardware and software, based on the principles of charge transfer. A measurement is taken and used for calculating appropriate outputs.

6.1 Charge Transfer Concepts

Capacitance measurements are taken with a charge transfer process that is periodically initiated. Self capacitive sensing measures the capacitance between the sense electrode (Cx) relative to ground. Projected capacitance sensing measures the capacitance between 2 electrodes referred to as the transmitter (CTX) and receiver (CRX). The measuring process is referred to as a charge transfer cycle and consists of the following:

- ❑ Discharging of an internal sampling capacitor (Cs) and the electrode capacitors (self: Cx or projected: CTX & CRX) on a channel.
- ❑ charging of Cx's / CTX's connected to the channel
- ❑ and then a series of charge transfers from the Cx's / CRX's to the internal sampling capacitors (Cs), until the trip voltage is reached.

The number of charge transfers required to reach the trip voltage on a channel is referred to as Counts (CS). The device continuously repeats charge transfers on the sense electrode connected to the Cx pin. For each channel a Long Term Average (LTA) is calculated (12 bit unsigned integer values). The counts (12 bit unsigned integer values) are processed and compared to the LTA to detect DYCAL, TOUCH and PROX events. For more information regarding capacitive sensing, refer to the application note "AZD004 - Azoteq Capacitive Sensing". **Please note: Attaching a probe to the**

CTX/CTX/CRX pin will influence the capacitance of the sense electrodes and therefore CS. This will have an immediate influence on CS.

7 Prox Module Setup

7.1 Self or Projected Capacitance

The IC can be used in either self or projected capacitance mode. The IC is default in self capacitance mode. This can be changed to projected capacitance mode through either a FG (one time programmable option) bit or in the first communication window with start-up (**use the setup window to set the IC to Projected mode**). The user should set the PROJ bit (bit 7) in the PROX_SETTINGS1 [0xD2H] register (refer to the Device Settings the Memory Map, available in Appendix B) to enable projected capacitance technology. The technology enabled on the IC will be reported in the SYSFLAGS [0x10H] register. Refer to the IQS253 communication interface application note for more details on the 'Setup Window'. This setting can only be sent to the IQS253 in the setup-communication-window. Please see the Section 9.1 for more information regarding this. Note that this Setup-Window is only available once after power-ON.

The IQS253 will always start-up in Event Mode (default after POR). Thus, after the initial Setup-Window, there will only be communication windows available upon Events (ATI, proximity, etc. Refer to the Event_Mask [0xD9H] register). Therefore, if the device is not set to continuous streaming mode (bit 2 in the PROX_SETTINGS2 [0xD3H] register) during the Setup-Window, the master controller will have to pull the RDY line low to force a communication window to setup additional settings. Please refer to application note [6] for guidelines

on setting up the IQS253.

When using more than one IQS253 device on the same I²C bus (especially when sharing a input pin on the master for the RDY lines), it is recommended to use the FG options to set the sensing technology (Self OR Projected) and the individual sub-addresses.

7.2 Rate of Charge Cycles

7.2.1 Boost Power rate

With all 3 channels active and the IQS253 in Boost Power (BP) mode, the Counts (CS) are charged at a fixed sampling frequency (f_{SAMPLE}) per channel. This is done to ensure regular samples for processing of results. It is calculated as each channel having a time ($t_{CHANNEL}$ = charge period (t_{CHARGE}) + computation time) of 9 ms, thus the time between consecutive samples on a channel (t_{SAMPLE}) will optimally be 27 ms (or 37 Hz).

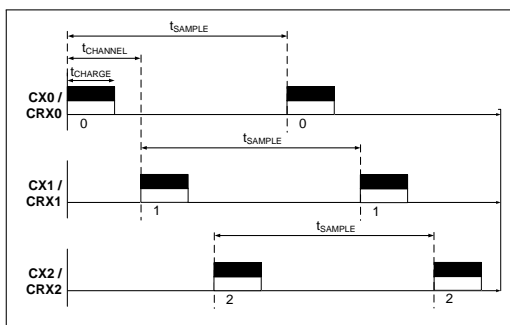

Figure 7.1: Boost power as on CX / CRXx.

For every channel disabled, the sampling rate on a channel will reduce with approximately 9ms.

7.2.2 Low Power Rates

Low current consumption charging modes are available. In any Low Power (LP) mode, there will be a t_{LP} low power time applicable. This is determined by the LOW_POWER register.

The value written into this register multiplied by 16ms will yield the LP time (t_{LP}). Please note that this time is only applicable from value 03 H and higher loaded into the LOW_POWER register. The values 01 H and 02 H will have a different time. See Table 12.6 for all timings. With the detection of an undebounced proximity event the IC will zoom to BP mode, allowing a very fast reaction time for further possible DYCAL /touch /proximity events. All active channels will be consecutively charged every T_{LP} . This succession of charge cycles are succeeded by the charging of CX2 /CRX2 as a dummy charge cycle. If a LP rate is selected through register LOW_POWER and charging is not in the zoomed in state (BP mode), the LP bit (SYSFLAGS register) will be set.

7.2.3 Halt Charge (HC)

Setting the HC bit will immediately cause the IC to stop doing conversions (stop measuring capacitance), set the RDY line as an input and enter a sleep mode. To wake up the IQS253, and let it continue with conversions, the RDY line should be pulled low for at least 1.6ms. The RDY line should thereafter be monitored again for communication windows. The HC bit in the memory map will automatically be cleared.

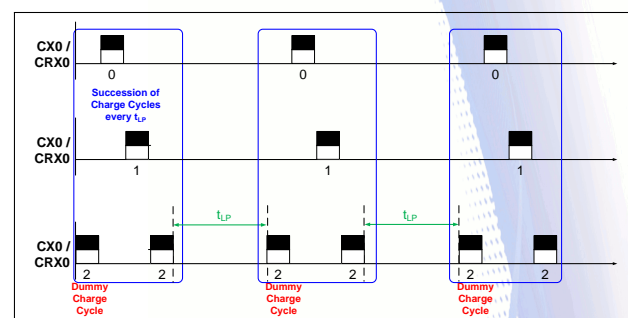

Figure 7.2: Charge cycles as charged in LP modes.



7.3 Report Rate

The report rate of the device depends on the charge transfer frequency, the number of channels enabled and the length of communications performed by the master device.

7.4 Active Channels

The user has the option to disable channels. This can be done in the ACTIVE_CHAN register. All 3 channels are enabled by default.

7.5 DYCAL™ or Direct Output

Each channel can be configured to either give a DYCAL™ (default) or a direct-output through the DYCAL_CHANS register. Configuring a channel as a direct-output channel will yield that the touch and prox indication bits will actively indicate whether a channel detects either of these events. The DYCAL™ function will not be applied to direct-channels and any combination of DYCAL™ or direct-output channels can be used.

7.6 Report Order (Channel Numbers)

The data is reported in the sequence; Ch0, Ch1, Ch2, Ch0, Ch1, Ch2, Ch0, etc. The channel number (CHAN_NUM) is used to indicate to which channel the rest of the data in the dataset belongs.

7.7 Transfer Frequency (f_{cx})

The frequency of the charge transfers can be selected adjusting the XFER_FREQx bits. An optimal transfer frequency must be selected for a specific application.

7.8 Counts

Capacitive measurements are available in these registers. The data has an AC noise filter applied, which helps the device to work in very noisy environments. The filter is default enabled.

7.8.1 Disabling AC Noise Filter

The AC noise filter can be disabled by setting bit ACF_DISABLE in the PROX_SETTINGS2 register. This will increase response times, at the expense of noise immunity.

7.9 Long Term Average (LTA)

The LTA filter can be seen as the baseline or reference value. The LTA is calculated to continuously adapt to any environmental drift. The LTA filter is calculated from the CS value for each channel. The LTA filter allows the device to adapt to environmental (slow moving) drift. Actuation (DYCAL, Touch or Prox) decisions are made by comparing the CS value with the LTA reference value. The 12bit LTA value is contained in the LTA_H and LTA_L registers.

7.9.1 Filter Adaptation Rates

The LTA will adapt with different rates depending in which state the IC is in. Calculating a new LTA value is a function of the old LTA and the newly measured CS. The percentage of CS used in this LTA calculation is specified as the filter adaptation rate. 100% specifies that there are no filtering and $LTA = CS$. A lower percentage value for the adaptation rate will yield a slower adaptation rate. The IQS253 contains 3 user adjustable adaptation rates.

Filter adaptation rate in non-TM

The LTA filter will adapt according to the LTA_ADAPT rate if the IQS253 is in non-TM and



no proximity event is detected. See Figure 5.1 for a visual representation.

Filter adaptation rate in TM

The LTA will adapt according to the LTA_ADAPT_IN rate if IC is IN Touch Mode (TM) and the LTA is adjusting towards CS. This rate will apply until LTA has reached CS. See Figure 5.1 for a visual representation.

Filter Halt in non-TM if $|LTA-CS| > 16$

The LTA will adapt according to the LTA_ADAPT_OUT rate if IC is in Touch Mode (TM), has reached the CS and

- Self: $CS < LTA + 16$

- Projected: $CS > LTA - 16$

This is the rate at which LTA adapts before CS is on its way OUT of TM. See Figure 5.1 for a visual representation.

7.9.2 Filter Reseed

Setting the RESEED bit in the PROX_SETTINGS0 register, will reseed LTA to:

- Self: 8 above CS

- Projected: 8 below CS

The IC will stay in the state in which it was before the command was issued. Thus, either non-TM or TM. The bit will automatically be cleared by the IC as soon as the command has been executed.

7.9.3 Filter Halting

LTA halt status The status of currently halted channels is displayed in this byte. With the IC in non-TM, it will only show that a channel is halted if it detected a proximity condition. Once a touch is detected the halting bit for that channel will be cleared. With the IC in TM, it will show halting bits of channels where:

Self: $CS > LTA + 16$ Projected: $CS < LTA - 16$ Force halt

Setting the FORCE_HALT bit will cause all LTA values to stop adapting to CS. This bit should be cleared for the IC to start adapting to the environment again. If the FORCE_HALT command was issued while a channel was in non-TM and a touch is made on that channel, it will cause the LTA to stay halted but decrease with the Touch Threshold for that channel.

Automatic LTA halting in non-TM

With the IC in non-TM, a proximity event will cause halting of the LTA. The halting options are:

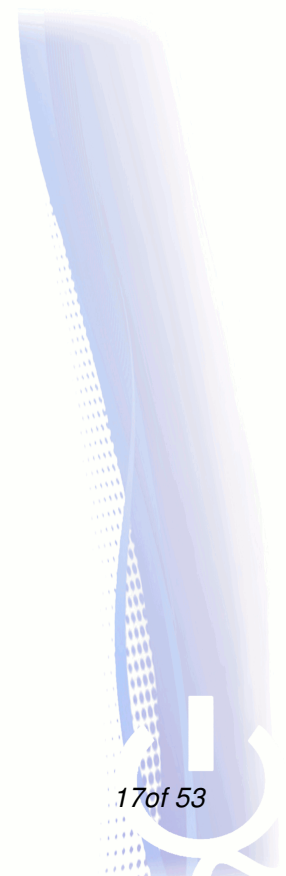



Table 7.1: LTA halting in non-TM.

HALT1:HALT0	t _{HALT}	Filter
0	Short (default)	During PROX, filter halts for 20s, then reseeds
1	Long	During PROX, filter halts for 40s, then reseeds
10	Never	Filter NEVER halts
11	Always	Filter is ALWAYS halted during a PROX detection

The halt times given in Table 7.1 will be extended when disabling channels. If the halt times in Table 7.1 are required while using less than 3 channels, the reseed command should be used from the master device.

Automatic LTA halting in TM

With the IC in TM and LTA within 16 counts of CS, no halting will occur. Halting will occur once:

- Self: LTA + Release threshold < CS > LTA + 16
- Projected: LTA - Release Threshold < CS < LTA - 16

ALWAYS_HALT_DYCAL = 0: The LTA will halt with the same conditions as stated in Table 7.1.

ALWAYS_HALT_DYCAL = 1: The LTA will always halt if above conditions apply.

The ALWAYS_HALT_DYCAL bit gives the designer more freedom, allowing different halting conditions for when the IC is in non-TM and in TM.

7.10 Determine Touch or Prox

An event is determined by comparing the CS with the LTA. Since the CS reacts differently when comparing the self with the projected capacitance technology, the user should consider only the conditions for the technology used.

- Self: CS < LTA - Threshold
- Projected: CS > LTA + Threshold

Threshold can be either a Proximity or Touch threshold.

7.10.1 Proximity

Thresholds:

Proximity thresholds can be adjusted individually for each channel and can be any integer values between 1 and 254.

Status:

The proximity status of the channels are indicated in the PROX register. The indication bits in this register should only be used if the applicable channel is configured into direct mode, otherwise the DYCAL status bits should be considered.

Debouncing:

By default, 6 consecutive samples should satisfy a proximity detection condition. This debounce can be adjusted to 4 through the PROX_DEBOUNCE bit in the PROX_SETTINGS3 register.

7.10.2 Touch Threshold and Status

Touch thresholds can be adjusted individually for each channel and are calculated as a function of the LTA.

$$TouchThreshold = (value / 256 * LTA) \quad (7.1)$$

where value can be any integer value between 1 and 254.

The proximity status of the channels are indicated in the TOUCH register. (The indication bits in this register should only be used if the applicable channel is configured into direct mode, otherwise the DYCAL status bits should be considered)

7.11 ATI

The Auto Tuning Implementation (ATI) is a sophisticated technology implemented in



ProxSense® devices. It allows optimal performance of the devices for a wide range of sensing electrode capacitances, without modification or addition of external components. The ATI allows the tuning of two parameters, an ATI Multiplier and an ATI Compensation, to adjust the sample value for an attached sensing electrode. ATI allows the designer to optimise a specific design by adjusting the sensitivity and stability of each channel through the adjustment of the ATI parameters. Partial ATI lets the designer specify the MULTIPLIER parameters instead of an actual base value. See Section 7.11.3. The IQS253 has an automated ATI function. The auto-ATI function is by default enabled, but can be disabled by setting the ATI_OFF bit. The ATI bit in the SYSFLAGS register will be set while an ATI event is busy.

7.11.1 ATI Sensitivity

The designer can specify the BASE values for each channel and a global TARGET value for all channels. A rough estimation of sensitivity can be calculated as:

$$\text{Sensitivity} = \text{TARGET} / \text{BASE} \quad (7.2)$$

As can be seen from this equation, the sensitivity can be increased by either increasing the TARGET or decreasing the BASE value. It should, however, be noted that a higher sensitivity will yield a higher noise susceptibility.

7.11.2 ATI Target

The target is reached by adjusting the COMPENSATION bits for each channel. The target value is written into the ATI_TARGET register. The value written into this register (0 to 255) multiplied by 8 will yield the new target value.

7.11.3 ATI Base (MULTIPLIER)

The following parameters will influence the base value:

- ❑ CS_SIZE : Size of sampling capacitor.
- ❑ PROJ_BIAS bits: Adjusts the biasing of some analogue parameters in the pro-

jected IC. (Only applicable in projected mode.)

- ❑ MULTIPLIER bits.

The base value used for the ATI function can be implemented in 2 ways:

1. ATI_PARTIAL = 0. ATI automatically adjusts MULTIPLIER bits to reach a selected base value. Base values are available in the CHx_ATI_BASE registers. By using the ALT_BASE bit, an extended list of base values are available.
2. ATI_PARTIAL = 1. The designer can specify the multiplier settings. These settings will give a custom base value from where the compensation bits will be automatically implemented to reach the required target value. The base value is determined by two sets of multiplier bits. **Sensitivity Multipliers** which will also scale the compensation to normalise the sensitivity and **Compensation Multipliers** to adjust the gain. Refer to the Memory Map where the multipliers bits can be set in registers CH0_ATI_BASE (0xC8) to CH2_ATI_BASE (0xCA).

7.11.4 Re-ATI

An automatic re-ATI event will occur if the CS is outside its re-ATI limits. The re-ATI limit is calculated as the target value divided by 8. For example: Target = 1024 Re-ATI will occur if CS is outside 1024 ±128. A re-ATI event can also be issued by the master by setting the REDO_ATI bit. It will clear automatically after the ATI event was started.

8 DYCAL™

The DYCAL™ technique is explained in Section 5. DYCAL™ detections are displayed in the DY-



CAL_OUT register. The IQS253 will also display whether each channel is in TM in the DYCAL_TM register. Important factors to consider when designing the DYCAL™ functionality are:

8.1 DYCAL™ channels enable

Explained in Section 7.5.

8.2 DYCAL™ on TOUCH/PROX

The DYCAL™ output bits can either be indicated when a proximity (default) or touch is detected by configuring the OUTPUT_ON_TOUCH bit.

8.3 LTA Adapt rates (IN and OUT)

Explained in Section 7.9.1.

8.4 Block Channel

A Touch on channel 1 can be used to block (and clear) the other channels' outputs. This is useful in Event Mode as the MCU can remain uninterrupted from the IQS253 while a touch is present on CH1.

- ❑ DYCAL_OUT if a channel is in DYCAL™ mode
- ❑ TOUCH if a channel is in direct-output mode

by setting bit BLOCK_ON_CH1_ENABLE. It should be noted that, if another channel had a DYCAL™ detection and channel 1 detects a touch event, it will clear the other channels' DYCAL™ outputs.

8.5 DYCAL™ Release Threshold

The release threshold is relevant for when a channel is released after it was in TM. It is dependent on the selected touch
Copyright © Azoteq

threshold and the setting chosen with bits REL_THR1:REL_THR0. (NOTE: the touch threshold can either be the user selected touch threshold or the dynamic touch threshold, whichever is larger)

Example:

Technology: Self Capacitive

$LTA_{NTM} = 1024$ (IC in NTM, before detection)

$LTA_{TM} = 850$ (IC in TM, after detection)

$Touch_{THR} = LTA_{NTM} * 30 / 256$

$Rel_{THR} = 75\% * Touch_{THR}$

Answer:

- ❑ The IQS253 detects a touch condition if: $CS < LTA_{NTM} - Touch_{THR}$, where $Touch_{THR} = 1024 * 30 / 256 = 120$. Thus if CS goes below $1024 - 120 = 904$. Channel is in TM.
- ❑ The IC will exit TM and clear the DYCAL_OUT bit if:
 $CS > LTA_{TM} + 0.75 * 120$ Thus if CS exceeds $850 + 90 = 940$ IC will exit TM and clear DYCAL_OUT.

8.6 DYCAL™ dynamic touch threshold

The IQS253 calculates a dynamic touch threshold. This dynamic threshold enables the IC to calculate more accurately when a user releases a button. The LTA will reseed to $[LTA - Touch_{THR}]$ once a touch is made. Using self capacitance as example; the CS will probably go much lower than the value to which the LTA reseeded. The IQS253 will only calculate the dynamic touch threshold once the LTA is within 16 counts of the CS.

8.7 10s_ATI_BLOCK

After a touch is released and the LTA is reseeded towards the CS, it is highly probable that the LTA will be outside the re-ATI boundaries of the IC. This feature helps the channels



to block the re-ATI function for 10 seconds after an actuation has been released. It is also applicable if a channel is configured in direct-output mode. The 10seconds block of re-ATI after an actuation can be disabled by setting the 10s_ATI_BLOCK bit.

8.8 250ms_DELAY_TM (t_{DYCAL})

By default, the LTA will only reseed to [LTA - Touch_{THR}] after t_{DYCAL} , when entering TM. An option exists to disable this delay, thus the LTA will reseed to [LTA - TouchThr] immediately with the detection of a touch.

8.9 Turbo Mode

The channels are charged in sequence and have a fixed period. By setting the Turbo_Mode bit, this period will be shortened to the fastest possible period, negating any dead-time. The AC filter will also be disabled for transfers to complete as fast as possible. If DYCAL is enabled, the Turbo_Mode bit will also allow the IC to enter Touch Mode as fast as possible upon an event.



9 Communication

The IQS253 can communicate on the I²C compatible bus structure. It uses the 2 wire serial interface bus which is I²C compatible and an optional RDY pin is available which indicates the communication window. The IQS253 has four available sub addresses, 44H (default) to 47H that is selected upon purchase of the IC. The maximum I²C compatible communication speed for the IQS253 is 400kbit/s. Please refer to AZD062 - IQS253 Communication Interface Guidelines [6] and the Memory Map in Appendix B for more details.

9.1 IC Setup Window

The IQS253 has a 'Setup Window' in which the user has the option to write some start-up settings before any conversions are done. For example, the 'Setup Window' can be used to change the IC from Self (default) to Projected sensing mode.

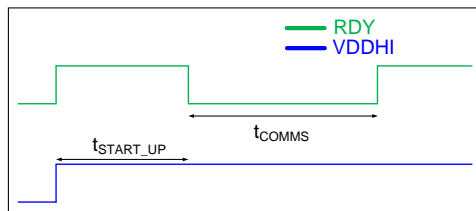

Figure 9.1: IC Setup Window.

T_{START_UP} after VDDHI was powered, RDY will go low for this 'Setup Window'. After addressing the IC, the required settings should be updated and only thereafter should a STOP bit be issued. The IC will then start with its conversions. If the 'Setup Window' is not serviced within t_{COMMS} , the RDY will go HIGH again (according to Section 9.3.3). Most settings can be updated at any time on the IC, except switching between Self and Projected capacitance technology, which can only be done in the 'Setup Window'. This setting can also be configured with a FG which would then not require setting up this function via I²C commands. As the Setup Window is only available once after POR, applications which do not have control over the IQS253 supply, or have more than one IQS253 on the bus should use the FG option to select

between Self or Projected capacitance.

9.2 Event Mode

IQS253 will in default be configured to only communicate with the master if a change in an event occurs (except for the Setup Window after POR). For this reason, it would be highly recommended to use the RDY line when communicating with the IQS253. These communication requests are referred to as EVENT Mode (only change of events are reported). Event mode can be disabled by setting the EVENT_MODE_DISABLE bit. The events responsible for resuming communication can be chosen through the EVENT_MASK register. By default all events are enabled. The master has the capability to force a communication window at any time, by pulling the RDY line low. The communication window will open directly following the current conversion.

9.3 I²C Specific Commands

9.3.1 Reset Indication

SHOW_RESET can be read to determine whether a reset occurred on the device. This bit will be a '1' after a reset. The value of SHOW_RESET can be cleared to '0' by writing a '1' in the ACK_RESET bit.

9.3.2 WDT

The WDT is used to reset the IC if a problem (for example a voltage spike) occur during communication. The WDT will time-out after T_{WDT} if no valid communication occur for this time.

9.3.3 Time-out

If no communication is initiated from the master within the first t_{COMMS} of the RDY line indicating that data is ready, the IC will resume with the next channel's charge transfers. This time-out can be disabled by setting the TIME_OUT_DISABLE bit.

9.4 I²C Read and Write specifics

Please refer to the Memory Map and Sample Code Document for the I²C read and write



specifics as implemented on most ProxSense[®] devices.





10 Boolean Output

Boolean arithmetic can be applied to one or a combination of channels to get a result. This result is available in the BOOLEAN_OUTPUT bit in the TOUCH register. For the self capacitive IQS253 version, a digital signal output pin (B_OUT) exists, which corresponds to the Boolean output bit. This output pin is to be used for level detection on a master controller, or to be used with a FET for LED driving. The pin is not rated to sink or source current. In both the self and projected configuration, the "Event Mode" communication could be triggered on a Boolean based result. The Boolean output will be calculated using:

- ❑ DYCAL_OUT if channel is in DYCAL™ mode
- ❑ TOUCH output if channel is in direct-output mode

10.1 Channels for Boolean operation

The channels that should be used to compute the Boolean output bit is chosen in the BOOLEAN_SETTINGS register.

10.2 Boolean NOT

A Boolean NOT can be applied to any or all channels.

10.3 Boolean AND/OR

The Boolean AND operation will be applied to the chosen channels. The OR operation can alternatively be applied if the BOOLEAN_AND_OR bit is set.

10.4 Order of Boolean operation:

1. Choose channels for Boolean operation
2. Should NOT be applied to a channel?

3. AND/OR operation?

11 RF Noise

11.1 Noise Immunity

The IQS253 has advanced immunity to RF noise sources such as GSM cellular telephones, DECT, Bluetooth and WIFI devices. Design guidelines should however be followed to ensure the best noise immunity. The design of capacitive sensing applications can encompass a large range of situations but as a summary the following should be noted to improve a design:

- ❑ A ground plane should be placed under the IC, except under the Cx line.
- ❑ All the tracks on the PCB must be kept as short as possible.
- ❑ The capacitor between VDDHI and VSS as well as between VREG and VSS, must be placed as close as possible to the IC.
- ❑ A 100 pF capacitor can be placed in parallel with the 1uF capacitor between VDDHI and VSS. Another 100 pF capacitor can be placed in parallel with the 1uF capacitor between VREG and VSS.
- ❑ When the device is too sensitive for a specific application a parasitic capacitor (max 5pF) can be added between the Cx line and ground.
- ❑ Proper sense electrode and button design principles must be followed.
- ❑ Unintentional coupling of sense electrode to ground and other circuitry must be limited by increasing the distance to these sources or making use of the driven shield.
- ❑ In some instances a ground plane some distance from the device and sense electrode may provide significant shielding from undesired interference.



When the capacitance between the sense electrode and ground becomes too large the sensitivity of the device may be influenced.

11.1.1 RF Detection

In cases of extreme RF interference, the on-chip RF detection is suggested. This detector can be enabled by setting the ND bit in the PROX_SETTINGS1 register. By connecting a suitable antenna to the RF pin, it allows the device to detect RF noise and notify the master of possible corrupt data. Noise affected samples are not allowed to influence the LTA filter, and also do not contribute to DYCAL, PROX or TOUCH detection. With the detection of noise, the NOISE bit in SYSFLAGS will be set.

11.1.2 RF detector sensitivity

The sensitivity of the RF detector can be selected by setting an appropriate RF detection voltage through the ND_TRIM bits. Please see AZD015 for further details regarding this.





12 Electrical Specifications

Absolute Maximum Specifications

The following absolute maximum parameters are specified for the device: Exceeding these maximum specifications may cause damage to the device.

<input type="checkbox"/> Operating temperature	−40 °C to +85 °C
<input type="checkbox"/> Supply Voltage (VDDHI - GND)	3.6 V
<input type="checkbox"/> Maximum pin voltage	VDDHI + 0.5 V
<input type="checkbox"/> Maximum continuous current (for specific Pins)	2 mA
<input type="checkbox"/> Minimum pin voltage	GND - 0.5 V
<input type="checkbox"/> Minimum power-on slope	100 V /s
<input type="checkbox"/> ESD protection (HBM)	±4 kV
<input type="checkbox"/> Moisture Sensitivity Level MSOP-10	MSL 1
<input type="checkbox"/> Moisture Sensitivity Level DFN-10	MSL 3

12.1 General Characteristics (Measured at 25 °C)

Table 12.1: IQS253 General Operating Conditions - Projected Capacitive Sensor.

DESCRIPTION	Conditions	PARAMETER	MIN	TYP	MAX	UNIT
Supply voltage		VDDHI	1.8	3.3	3.6	V
Internal regulator output	$1.8 \leq VDDHI \leq 3.3$	VREG	1.62	1.7	1.79	V
Boost Power operating current	$1.8 \leq VDDHI \leq 3.3$ LOW_POWER = 00h	I_{BP}		180	<250	μA
Low power 32 operating current	$1.8 \leq VDDHI \leq 3.3$ LOW_POWER = 20h	I_{LP32}		13	<20	μA
Low power 255 operating current	$1.8 \leq VDDHI \leq 3.3$ LOW_POWER = FFh	I_{LP255}		4.5	<8	μA

Table 12.2: IQS253 General Operating Conditions - Self Capacitive Sensor.

DESCRIPTION	Conditions	PARAMETER	MIN	TYP	MAX	UNIT
Supply voltage		VDDHI	1.8	3.3	3.6	V
Internal regulator output	$1.8 \leq VDDHI \leq 3.3$	VREG	1.62	1.7	1.79	V
Boost Power operating current	$1.8 \leq VDDHI \leq 3.3$ LOW_POWER = 00h	I_{BP}		150	<200	μA
Low power 32 operating current	$1.8 \leq VDDHI \leq 3.3$ LOW_POWER = 20h	I_{LP32}		11	<15	μA
Low power 255 operating current	$1.8 \leq VDDHI \leq 3.3$ LOW_POWER = FFh	I_{LP255}		3.5	<6	μA





Table 12.3: Start-up and shut-down slope Characteristics

Description	Condition	Parameter	MIN	MAX	Unit
POR	VDDHI Slope ≥ 100 V/s	POR	1.2	1.6	V
BOD		BOD	1.15	1.55	V

Table 12.4: Debounce employed on IQS253.

DESCRIPTION	Conditions	Value
Proximity debounce value	PROX_DEBOUNCE = 0	6
	PROX_DEBOUNCE = 1	4
Touch debounce value	-	2

12.2 Timing Characteristics

Table 12.5: General Timing Characteristics for $1.80\text{V} \leq \text{VDDHI} \leq 3.60\text{V}$

SYMBOL	DESCRIPTION	TYP	UNIT
$t_{\text{START-UP}}$	Start-up time before the Setup Window is initiated by the IQS253	15	ms
t_{COMMS}	Time after which communication window will terminate, if not addressed	22	ms
f_{CX}	IC transfer frequency	See XFER_FREQ in IQS253 Memory Map	MHz
t_{CHARGE}	Charge time of channel	$\text{CS} * (1/f_{\text{CX}})$	ms
t_{CHANNEL}	Charge time interval	9.01ms	
t_{SAMPLE}	Sample time of channel	Active channels * t_{CHANNEL}	ms
t_{BP}	Channel sampling period in BP and Turbo_Mode = OFF	t_{SAMPLE}	ms
$t_{\text{BP_TURBO}}$	Channel sampling period in BP and Turbo_Mode = OFF	Active channels * t_{CHARGE}	ms
t_{LP}	Low Power Charging time	$\text{CS} * (1/f_{\text{CX}}) + t_{\text{CHARGE}}$	
t_{WDT}	WDT time-out while communicating	160	ms
t_{DYCAL}	Time before switching to TM in DYCAL TM operation	$225 \leq 250 \leq 275$	ms



Table 12.6: IQS253 charging times

Power Mode	Typical (ms)
Boost Power Mode with Turbo_Mode ON	4
Boost Power Mode	9
Low Power Mode 4	64
Low Power Mode 8	128
Low Power Mode 16	256
Low Power Mode 32	512
Low Power Mode 64	1024
Low Power Mode 255	4080

Table 12.7: IQS253 DYCAL (OUTPUT_ON_TOUCH = 0) /Proximity Response Times

Power Mode	Conditions	Min**	Unit
Boost Power Mode with Turbo_Mode ON ¹	Detection with small CS change (prox) and ACF OFF	135	ms
	Detection with large CS change (touch) and ACF OFF	81	
	Release time with ACF OFF	81	ms
Boost Power Mode ²	Detection with large CS change (touch) and ACF OFF	331	ms
	Release time with ACF OFF	81	ms
Power Modes ³	See example	See example	ms
	See example (take 250ms off total time)		ms

****Note:** Minimum bit set times are dependent on the size of the change in CS caused by the user actuation because the minimum time is a function of the debounce of either the touch / proximity caused. The setting of indication bits are delayed by a charge transfer cycle. With ACF = ON, detection and release times will dramatically increase due to the CS having to go through a filtering process adding a delay

LP Response time Example:

LOW_POWER = 34h (52D): $t_{LP} = 16ms \times 52 = 832ms$

Channels active = 2: $t_{SAMPLE} = 18ms + 9ms$ for extra Channel 2 sampling

ACF = OFF: Fast response on CS

Large CS change: Touch debounce = 2

DetectionTimeLP52 = $27 + 832 + (2 + 1) \times 27 + 250 = 1.19seconds$

¹Minimum Detection and Release times = (debounce + 1) x t_{SAMPLE}

²Boost Power Detection and Release times = (debounce + 1) x $t_{SAMPLE} + 250ms$

³LP Modes = $t_{SAMPLE} + t_{LP} + (debounce + 1) \times t_{SAMPLE} + 250m$



13 Mechanical Dimensions

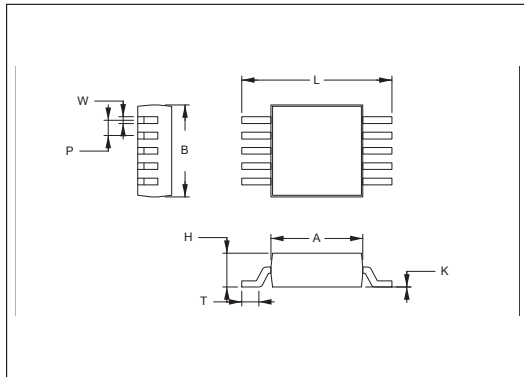

Figure 13.1: MSOP10 Package.

Table 13.1: MSOP10 Package Dimensions.

Dimension	[mm]
A_{min}	2.90
A_{max}	3.10
B_{min}	2.90
B_{max}	3.10
H_{max}	1.1
L_{min}	4.75
L_{max}	5.05
T_{min}	0.40
T_{max}	0.80
Pitch	0.50
W_{min}	0.17
W_{max}	0.27

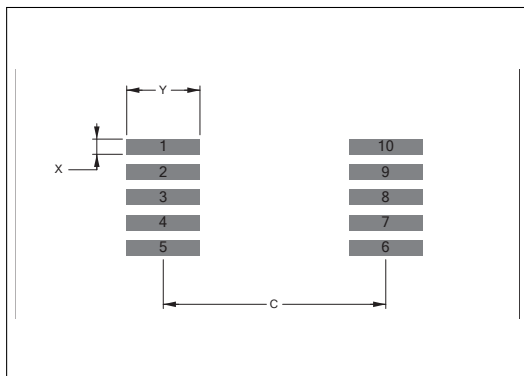

Figure 13.2: MSOP10 Footprint.

Table 13.2: MSOP-10 Footprint Dimensions

Dimension	mm
Pitch	0.50
C	4.40
Y	1.45
X	0.30

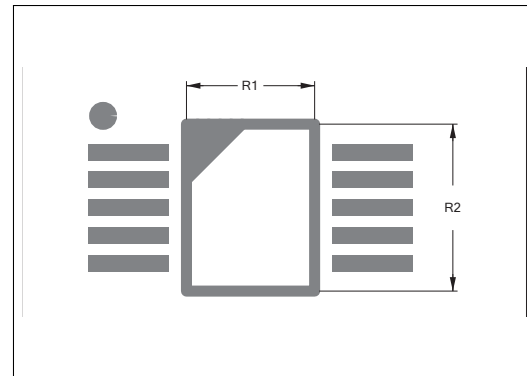

Figure 13.3: MSOP10 Silk Screen.

Table 13.3: MSOP-10 Silk Screen Dimensions

Dimension	mm
R1	2.30
R2	3.00

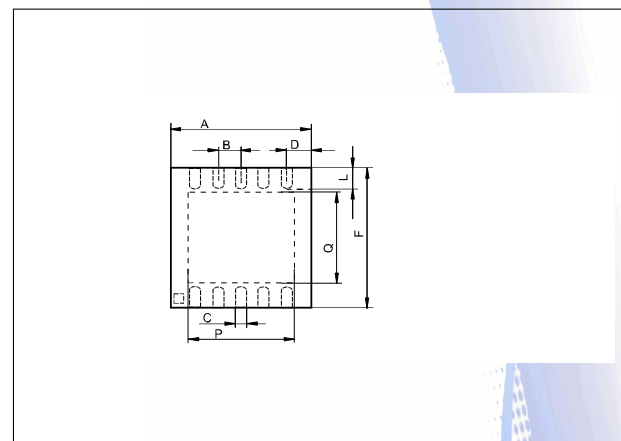

Figure 13.4: DFN-10 Package Dimensions.

Table 13.4: DFN-10 Package Dimensions.

Dimension	[mm]
A	3 ± 0.1
B	0.5
C	0.25
D	
F	3 ± 0.1
L	0.4
P	2.4
Q	1.65

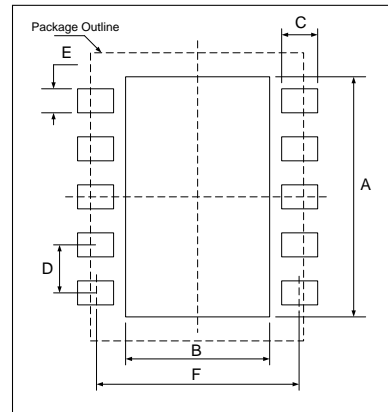

Figure 13.6: DFN-10 Footprint.

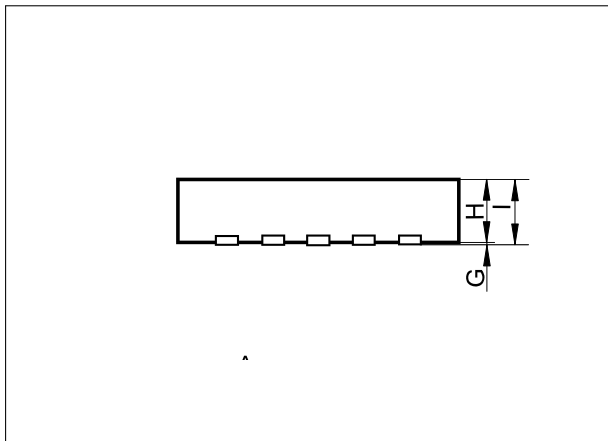

Figure 13.5: DFN-10 package Side View.

Table 13.6: DFN-10 Footprint Dimensions

Dimension	mm
A	2.38
B	1.64
C	0.60
D	0.50
E	0.25
F	2.80

Table 13.5: DFN-10 Side View Dimensions.

Dimension	mm
G	0.05
H	0.65
I	0.7 - 0.8





14 Device Marking

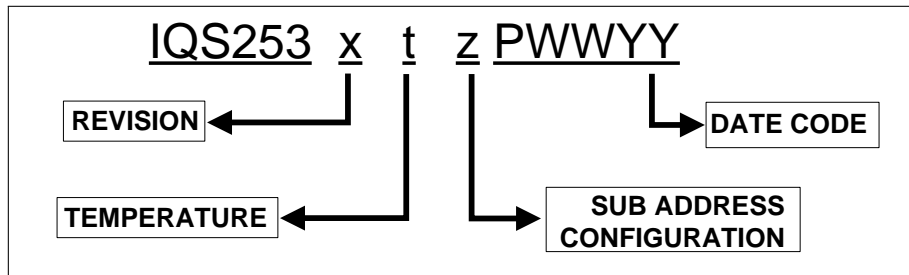

Pin1 mark on package - Bottom Left.

REVISION	x	=	IC Revision Number
TEMPERATURE RANGE	t	=	I –40 °C to 85 °C (Industrial) C 0 °C to 70 °C (Commercial)
IC CONFIGURATION	z	=	Configuration (Hexadecimal) 0 = 44H (Self Capacitance) 1 = 45H (Self Capacitance) 2 = 46H (Self Capacitance) 3 = 47H (Self Capacitance) 4 = 44H (Projected Capacitance) 5 = 45H (Projected Capacitance) 6 = 46H (Projected Capacitance) 7 = 47H (Projected Capacitance)
DATE CODE	P	=	Package House
	WW	=	WEEK
	YY	=	YEAR

15 Ordering Information

Orders will be subject to a MOQ (Minimum Order Quantity) of a full reel. Contact the official distributor for sample quantities. A list of the distributors can be found under the "Distributors" section of www.azoteq.com. The IQS253 has 4 I²C sub-addresses available. The default address is 0x44H. For further enquiries regarding this, please contact Azoteq or a local distributor.

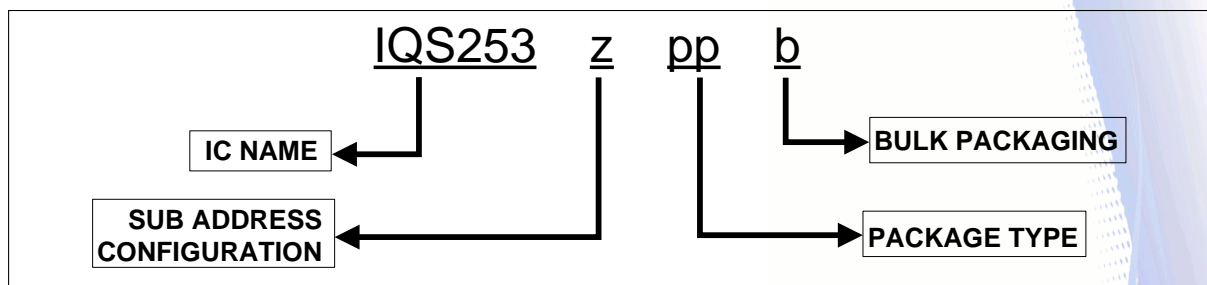



IC NAME	IQS253	=	IQS253
BOTTOM MARKING	z	=	I ² C Sub Address (hexadecimal)
PACKAGE TYPE	MS	=	MSOP-10
	DN	=	DFN-10
BULK PACKAGING	R	=	Reel (MSR 4000pcs/reel) - MOQ = 4000pcs
	R	=	Reel (DNR 3000pcs/reel) - MOQ = 3000pcs
	T	=	Tube (96pcs/tube, Special Order, MS Only)

16 Device Revision History

Revision	Device ID	Package Markings	Comments
0	3114	x3911	Projected Bias current default 10uA Unable to float CX/CRX
			No Event mode with Boolean Output enabled
1	4100	x0112 or later	Projected Bias current default 5uA

17 Errata

The 'z' field is omitted on the package marking on batch code 21512. The configuration is '0' on this lot.





18 Contact Information

PRETORIA OFFICE

Physical Address
160 Witch Hazel Avenue
Hazel Court 1, 1st Floor
Highveld Techno Park
Centurion, Gauteng
Republic of South Africa
Tel: +27 12 665 2880
Fax: +27 12 665 2883
Postal Address
PO Box 16767
Lyttelton
0140
Republic of South Africa

PAARL OFFICE

Physical Address
109 Main Street
Paarl
7646
Western Cape
Republic of South Africa
Tel: +27 21 863 0033
Fax: +27 21 863 1512
Postal Address
PO Box 3534
Paarl
7620
Republic of South Africa

The following patents relate to the device or usage of the device: US 6,249,089 B1, US 6,621,225 B2, US 6,650,066 B2, US 6,952,084 B2, US 6,984,900 B1, US 7,084,526 B2, US 7,084,531 B2, US 7,119,459 B2, US 7,265,494 B2, US 7,291,940 B2, US 7,329,970 B2, US 7,336,037 B2, US 7,443,101 B2, US 7,466,040 B2, US 7,498,749 B2, US 7,528,508 B2, US 7,755,219 B2, US 7,772,781, US 7,781,980 B2, US 7,915,765 B2, EP 1 120 018 B1, EP 1 206 168 B1, EP 1 308 913 B1, EP 1 530 178 B1, ZL 99 8 14357.X, AUS 761094

IQ Switch®, ProxSense®, LightSense™, AirButton® and the  logo are trademarks of Azoteq.

The information appearing in this Datasheet is believed to be accurate at the time of publication. Azoteq assumes no liability arising from the use of the information or the product. The applications mentioned herein are used solely for the purpose of illustration and Azoteq makes no warranty or representation that such applications will be suitable without further modification, nor recommends the use of its products for application that may present a risk to human life due to malfunction or otherwise. Azoteq products are not authorised for use as critical components in life support devices or systems. No licenses to patents are granted, implicitly or otherwise, under any intellectual property rights. Azoteq reserves the right to alter its products without prior notification. For the most up-to-date information, please refer to www.azoteq.com.





A Appendix A

Dycal™ Illustrations

To view the illustrations in Appendix A, the document requires to be opened with Adobe Reader Version 6 or later. Note that all illustrations are supplementary, and are not required to use with the datasheet.

Figure A.1: DYCAL output selected on proximity, for a projected capacitive IC. Note that the IC still only enters TM (Touch Mode) when the counts exceed the touch threshold, but the DYCAL output is active after exceeding the proximity threshold.

Figure A.2: DYCAL output selected on touch, for a projected capacitive IC. Note that the DYCAL output is only active when the IC enters TM (Touch Mode) when the counts exceed the touch threshold.





Figure A.3: Filter halt upon Touch Mode Entry, for a self capacitive IC. The LTA will halt upon proximity detection (regardless on which output DYCAL was selected). However, when a touch condition is registered, the filter will stop halting, to allow the LTA to follow the counts.





B Appendix B

IQS253 Memory Map

The Memory Map of the IQS253 is provided in this section, along with a description of each register and instruction. The IQS253 communicates via I²C. For an example implementation that provides example code, refer to [6].

The general ProxSense® Memory Map is shown below.

Address	Access	Size(Bytes)	Device Information
00H-0FH	R	16	

Address	Access	Size(Bytes)	Device Specific Data
10H-30H	R	32	

Address	Access	Size(Bytes)	Proximity Status Bytes
31H-34H	R	4	

Address	Access	Size(Bytes)	Touch Status Bytes
35H-38H	R	4	

Address	Access	Size(Bytes)	Halt Bytes
39H-3CH	R	4	

Address	Access	Size(Bytes)	Active Bytes (indicate cycle)
3DH-41H	R	4	

Address	Access	Size(Bytes)	Counts
42H-82H	R	64	

Address	Access	Size(Bytes)	LTAs
83H-C3H	R/W	64	

Address	Access	Size(Bytes)	Device Settings
C4h-FDh	R/W	64	

Note: FE and FF are reserved for other functions in communication.

B.1 IQS253 Memory Map





B.1.1 Device Information

00H		Product Number (PROD_NR)							
Access	Bit	7	6	5	4	3	2	1	0
R	Value	41 (Decimal)							

01H		Software Number (SW_NR)							
Access	Bit	7	6	5	4	3	2	1	0
R	Value	SW_NR							

[00H] PROD_NR

The product number for the IQS253 is 41 (decimal).

[01H] SW_NR

The software version number of the device ROM can be read in this byte. Production version IC's SW numbers are 0 for Self and Projectd. The Engineering version numbers are shown below.

IQS253 sw nr	Description
13 (decimal)	IQS253 - 3 Channel Self Capacitive Sensor version 1
14 (decimal)	IQS253 - 3 Channel Projected Sensor version 1

B.1.2 Device Specific Data

10H		System Flags (SYSFLAGS)							
Access	Bit	7	6	5	4	3	2	1	0
R	Name	System_ Use	SYSTEM_ Use	SHOW_ Reset	PROJ_ Mode	LP	ATI_ Busy	Noise	Zoom

[10H] SYSFLAGS

bit 7: SYSTEM_USE

bit 6: SYSTEM_USE

bit 5: SHOW_RESET: This bit can be read to determine whether a reset occurred on the device since the ACK_RESET bit has been set. The value of SHOW_RESET can be set to 0 by writing a 1 in the ACK_RESET bit in the PROX_SETTINGS_2 byte.

bit 4: PROJ_MODE: Capacitive Sensing Technology used

0 = Self Capacitive sensing

1 = Projected Capacitive sensing

bit 3: LP: If a LP mode is enabled, this bit indicates that charging is currently occurring in a LP rate.

0 = Full-speed charging

1 = Charging currently occur at a lower rate

bit 2: ATI_BUSY: Status of automated ATI routine

0 = Auto ATI is not busy

1 = Auto ATI in progress



bit 1: NOISE: This bit indicates the presence of noise interference.

0 = IC has not detected the presence of noise

1 = IC has detected the presence of noise

bit 0: ZOOM: Zoom will indicate full-speed charging once an undebounced proximity is detected. In NP mode, this will not change the charging frequency.

0 = IC not zoomed in

1 = IC detected undebounced proximity and IC is charging at full-speed

B.1.3 Proximity Status Bytes

The proximity status of all the channels on the device are shown here. These bits should not be monitored if the IC is in DYCAL mode.

31H		Proximity Status (PROX)							
Access	Bit	7	6	5	4	3	2	1	0
R	Name						CH2	CH1	CH0

[31H] PROX

The proximity status of the channels is indicated in this byte. The PROX bit of a channel should not be used if a channel is set as a DYCAL channel.

bit 7-3: SYSTEM_USE

bit 2: CH2: Indicate that a proximity event has been detected on CH2

0 = No proximity event detected

1 = Proximity event detected

bit 1: CH1: Indicate that a proximity event has been detected on CH1

0 = No proximity event detected

1 = Proximity event detected

bit 0: CH0: Indicate that a proximity event has been detected on CH0

0 = No proximity event detected

1 = Proximity event detected

B.1.4 Touch Status Bytes

The touch status of all the channels on the device are shown here. These bits should not be monitored if the IC is in DYCAL mode.

35H		Touch Status (TOUCH)							
Access	Bit	7	6	5	4	3	2	1	0
R	Name	Boolean_Output					CH2	CH1	CH0

[35H] TOUCH

The touch status of the channels is indicated in this byte. The TOUCH bit of a channel should not be used if a channel is set as a DYCAL channel.

bit 7: BOOLEAN_OUTPUT: A Boolean combination can be outputted to this bit. The Boolean combination can be configured through bytes BOOLEAN_SETTINGS and BOOLEAN_NOT. This bit will correspond with the output status of the B_OUT pin of the IQS253 Self capacitive IC.

0 = Boolean Output not active





1 = Boolean Output active

bit 6-3: Unused

bit 2: CH2: Indicate that a touch event has been detected on CH2

0 = No touch event detected

1 = Touch event detected

bit 1: CH1: Indicate that a touch event has been detected on CH1

0 = No touch event detected

1 = Touch event detected

bit 0: CH0: Indicate that a touch event has been detected on CH0

0 = No touch event detected

1 = Touch event detected

B.1.5 DYCAL Touch Mode indication

36H		DYCAL TM Indication (DYCAL_TM)							
		Bit	7	6	5	4	3	2	1
Access	R	Name					CH2	CH1	CH0
		Note	Indicates if Channel is in TM						

[36H] DYCAL_TM

If a channel is configured as a DYCAL channel, these bits will indicate whether TM has been entered. TM is entered once the touch threshold of a channel has been exceeded.

Bit 7-3: Unused

Bit 2: CH2: CH2 TM indication

0 = Channel not in TM

1 = Channel in TM

Bit 1: CH1: CH1 TM indication

0 = Channel not in TM

1 = Channel in TM

Bit 0: CH0: CH0 TM indication

0 = Channel not in TM

1 = Channel in TM

B.1.6 DYCAL Output indication

37H		DYCAL Output Indication (DYCAL_OUT)							
		Bit	7	6	5	4	3	2	1
Access	R	Name					CH2	CH1	CH0
		Note	Indicates a DYCAL detection on a channel						

[37H] DYCAL_OUT

If a channel is configured as a DYCAL channel, these bits will indicate whether the DYCAL output is set. It will default be set with the detection of a proximity, but can be set by a touch by configuring bit DYCAL_SETTINGS:OUTPUT_ON_TOUCH.



Bit 7-3: Unused

Bit 2: CH2: CH2 DYCAL output

- 0 = DYCAL not detected
- 1 = DYCAL detected

Bit 1: CH1: CH1 DYCAL output

- 0 = DYCAL not detected
- 1 = DYCAL detected

Bit 0: CH0: CH0 DYCAL output

- 0 = DYCAL not detected
- 1 = DYCAL detected

B.1.7 Halt Bytes

The LTA filter halt status of all the channels are shown here.

39H		LTA Halt Status (HALT)							
Access	Bit	7	6	5	4	3	2	1	0
R	Name						CH2	CH1	CH0

[39H] HALT

Indicate the halting state of each channels Long Term Average (LTA). If in non-TM, the halt bit of a channel will be set once proximity is detected. Once a touch is detected, the IC will enter TM and the halt bit will be cleared. The halting bit will now only be set again if the CS exceeds the LTA by 16 in Self or if the CS is less than the LTA by more than 16 in Projected mode.

Bit 7-3: Unused

Bit 2: CH2: CH2 LTA halting state

- 0 = Channels LTA adapts to the environment
- 1 = Channels LTA halted

Bit 1: CH1: CH1 halting state

- 0 = Channels LTA adapts to the environment
- 1 = Channels LTA halted

Bit 0: CH0: CH0 halting state

- 0 = Channels LTA adapts to the environment
- 1 = Channels LTA halted

B.1.8 Channel Number

3DH		Channel Number							
Access	Bit	7	6	5	4	3	2	1	0
R	Value	Variable (0-2)							
	Note	Indicates which channels data is currently available							

[3DH] CHAN_NUM

The channel number that can be read in this byte indicates which channels data is currently available.

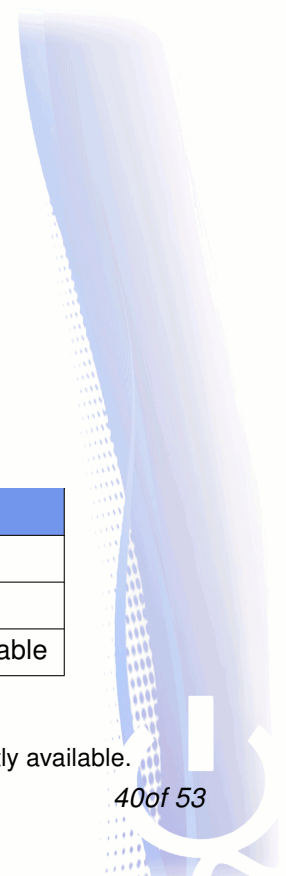



B.1.9 Counts

The Counts of the current channel is available here.

		Counts (CS_H)								
		Bit	7	6	5	4	3	2	1	0
42H	Access	Value	Variable (HIGH byte)							
	R	Note	Counts of active channel (see Channel Number)							

		Counts (CS_H)								
		Bit	7	6	5	4	3	2	1	0
43H	Access	Value	Variable (LOW byte)							
	R	Note	Counts of active channel (see Channel Number)							

[42H & 43H] CS_H & CS_L

The counts for the current channel can be read in this byte. The HIGH byte and LOW byte are found in consecutive addresses.

B.1.10 Long-Term Averages

The Long-Term average of the current channel is available here to read.

		Long-Term Average (LTA_H)								
		Bit	7	6	5	4	3	2	1	0
83H	Access	Value	Variable (HIGH byte)							
	R	Note	LTA of active channel (see Channel Number)							

		Long-Term Average (LTA_L)								
		Bit	7	6	5	4	3	2	1	0
84H	Access	Value	Variable (LOW byte)							
	R	Note	LTA of active channel (see Channel Number)							

[83H & 84H] LTA_H & LTA_L

The LTA value for the current channel can be read in this byte. The HIGH byte and LOW byte are found in consecutive addresses.

B.1.11 Device Settings

It is attempted that the commonly used settings are situated closer to the top of the memory block. Settings that are regarded as more once-off are placed further down.

		ATI Target Value (ATI_TARGET)								
		Bit	7	6	5	4	3	2	1	0
C4H	Access	Value	ATI Target value (x8 to get real target)							
	R/W	Default	1	0	0	0	0	0	0	0
		Note	128 Decimal (x8 gives Target value = 1024)							



[C4H] ATI_TARGET

The automated ATI target can be set in this byte. The value written to this byte multiplied by 8 will be the target value of all 3 channels. If a new target value is required, the required target (divided by 8) should be written to this byte, where-after a re-ATI event should be sent. All 3 channels will now be at the target value once the SYSFLAGS_ATI_BUSY flag is cleared. ATI Multiplier and Compensation

The ATI Multiplier and ATI Compensation bits allow the controller to be compatible with a large range of sensors, and in many applications with different environments. ATI allows the user to maintain a specific sample value on all channels. The ATI Multiplier parameters would produce the largest changes in sample values and can be thought of as the high bits of ATI. The ATI Compensation bits are used to influence the sample values on a smaller scale to provide precision when balancing all channels as close as possible to the target. The ATI Multiplier parameters are further grouped into two parameters namely ATI Multiplier-Compensation and ATI Multiplier-Sensitivity. ATI multiplier-Compensation consists of 2 bits and has the biggest effect on the sample value and can be considered as the highest bit of the ATI parameters. The ATI Multiplier-Sensitivity can be adjusted with 4 bits for each channel. The value of 1111 would provide the highest CS value and the value of 0000 would provide the lowest.

C5H		CH0 Compensation (COMP0)							
		Bit	7	6	5	4	3	2	1
Access	Value	Automatically adjusted when ATI enabled							
R/W	Default	0							

C6H		CH1 Compensation (COMP1)							
		Bit	7	6	5	4	3	2	1
Access	Value	Automatically adjusted when ATI enabled							
R/W	Default	0							

C7H		CH2 Compensation (COMP2)							
		Bit	7	6	5	4	3	2	1
Access	Value	Automatically adjusted when ATI enabled							
R/W	Default	0							

[C5H, C6H, C7H] Compensation Settings (CH0_COMP, CH1_COMP, CH2_COMP)

The compensation settings for each channel are contained in these bytes. The values in these bytes are automatically determined if the Auto ATI function was used. If PROX_SETTINGS0:ATI_OFF is set, the Automatic ATI setting is disabled and this byte can be altered to achieve a custom target value. The ATI Compensation parameter can be configured for each channel in a range between 0-255 (decimal). The ATI compensation bits can be used to make small adjustments of the sample values of the individual channels.

C8H		CH0 ATI BASE and Multipliers (CH0_ATI_BASE)							
		Bit	7	6	5	4	3	2	1
Access	Value	CH0_BASE1	CH0_BASE0	MULT_COMP1	MULT_COMP0	MULT_SENSE3	MULT_SENSE2	MULT_SENSE1	MULT_SENSE0
R/W		gain				scale			





		CH1 ATI BASE and Multipliers (CH1_ATI_BASE)							
		7	6	5	4	3	2	1	0
Access	Bit	CH1_	CH1_	MULT_	MULT_	MULT_	MULT_	MULT_	MULT_
	R/W	BASE1	BASE0	COMP1	COMP0	SENSE3	SENSE2	SENSE1	SENSE0

		CH2 ATI BASE and Multipliers (CH2_ATI_BASE)							
		7	6	5	4	3	2	1	0
Access	Bit	CH2_	CH2_	MULT_	MULT_	MULT_	MULT_	MULT_	MULT_
	R/W	BASE1	BASE0	COMP1	COMP0	SENSE3	SENSE2	SENSE1	SENSE0

[C8H, C9H, CAH] Base values and Multiplier settings (CH0_BASE, CH1_BASE, CH2_BASE)

The base value or Multiplier settings of each channel can be set in these bytes.

Bit 7-6: CHx_BASE1:CHx_BASE0: Channel base values ALT_BASE = 0; ALT_BASE = 1

00 = 200; 00 = 150

01 = 50; 01 = 350

10 = 100; 10 = 500

11 = 250; 11 = 700

Bit 5-4: MULT_COMP1:MULT_COMP0: Multiplier Compensation setting.

00 = 1:1 (smallest)

01 = 3:1

10 = 1:3

11 = 1:9

Bit 3-0: MULT_SENSE3:MULT_SENSE0: Multiplier Sensitivity setting

0000 = 1 (smallest)

0001 = 2

0010 = 3

0011 = 4

0100 = 5

0101 = 6

0110 = 7

0111 = 8

1000 = 9

1001 = 10

1010 = 11

1011 = 12

1100 = 14

1101 = 14

1110 = 16

1111 = 18

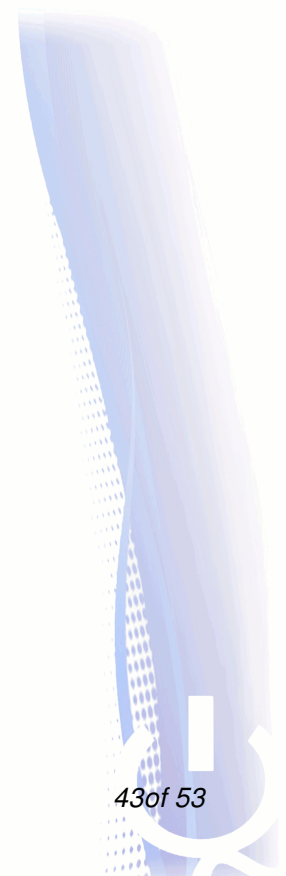



		Proximity Sensitivity Threshold (PROX_THR_CH0)							
CBH	Bit	7	6	5	4	3	2	1	0
Access	Name	PT_7	PT_6	PT_5	PT_4	PT_3	PT_2	PT_1	PT_0
R/W	Default	0	0	0	0	0	1	0	0

		Proximity Sensitivity Threshold (PROX_THR_CH1)							
CCH	Bit	7	6	5	4	3	2	1	0
Access	Name	PT_7	PT_6	PT_5	PT_4	PT_3	PT_2	PT_1	PT_0
R/W	Default			0	0	0	1	0	0

		Proximity Sensitivity Threshold (PROX_THR_CH2)							
CDH	Bit	7	6	5	4	3	2	1	0
Access	Name	PT_7	PT_6	PT_5	PT_4	PT_3	PT_2	PT_1	PT_0
R/W	Default			0	0	0	1	0	0

[CBH, CCH & CDH] Proximity Sensitivity Settings (PROX_TH_CHx)

Proximity sensitivity thresholds can be anything from 1 to 64.

		Touch Sensitivity Threshold (TOUCH_THR_CH0)							
CEH	Bit	7	6	5	4	3	2	1	0
Access	Name	TT_5	TT_5	TT_5	TT_4	TT_3	TT_2	TT_1	TT_0
R/W	Default	0	0	1	0	0	0	0	0
	Note	$Touch_{THR} = (value / 256 * LTA)$							

		Touch Sensitivity Threshold (TOUCH_THR_CH1)							
CFH	Bit	7	6	5	4	3	2	1	0
Access	Name	TT_5	TT_5	TT_5	TT_4	TT_3	TT_2	TT_1	TT_0
R/W	Default	0	0	1	0	0	0	0	0
	Note	$Touch_{THR} = (value / 256 * LTA)$							

		Touch Sensitivity Threshold (TOUCH_THR_CH2)							
D0H	Bit	7	6	5	4	3	2	1	0
Access	Name	TT_5	TT_5	TT_5	TT_4	TT_3	TT_2	TT_1	TT_0
R/W	Default	0	0	1	0	0	0	0	0
	Note	$Touch_{THR} = (value / 256 * LTA)$							

[CEH, CFH & D0H] Touch Sensitivity Settings (TOUCH_TH_CHx)

Touch sensitivity thresholds are calculated as a fraction of the LTA: $Touch_{THR} = (TOUCH_THR_CHx / 256 * LTA)$. There are 256 possible touch threshold values.





D1H		ProxSense Module Settings 0 (PROX_SETTINGS0)							
		Bit	7	6	5	4	3	2	1
Access	Value	ATI_OFF	ATI_PARTIAL	10s_ATI_BLOCK	REDO_ATI	RESEED	CS_SIZE	PROJ_BIAS1	PROJ_BIAS0
R/W	Default	0	0	1	0	0	1	1	1

[D1H] PROX_SETTINGS0

Bit 7: AUTO_ATI: Disables the automated ATI routine. By enabling this bit, the device will not be able to redo ATI if the counts are outside their boundaries.

0 = Auto ATI routine active

1 = ATI disabled

Bit 6: ATI_PARTIAL: Enable Partial ATI.

0 = If ATI occur, it will use the base values as reference

1 = If ATI occur, it will use the MULTIPLIER_COMPx and MULTIPLIER_SENSx as reference

Bit 5: ATI_BLOCK: Enable the 10 second block of ATI after an actuation.

0 = Channels will always redo ATI if LTA is outside boundaries if no actuation is detected

1 = ATI will be blocked for 10 seconds after an actuation has occurred.

Bit 4: REDO_AUTO_ATI: Force the ATI routine to perform. The last written ATI_TARGET value will be used as target.

0 = No action

1 = Force ATI routine to perform.

Bit 3: RESEED: Reseed the LTA filter. This can be used to adapt to an abrupt environment change, where the filter is too slow to track this change. Note that with the Short and Long Halt selections, an automatic Reseed will be performed when the halt time has expired, thus automatically adjusting to the new surroundings.

0 = Do not reseed

1 = Reseed (this is a global reseed)

Bit 2: CS: Set the size of the internal sampling capacitor. A larger CS capacitor requires more transfers (higher counts) to be charged.

0 = 29.9pF

1 = 59.8pF

Bit 1-0: PROJ_BIAS1:PROJ_BIAS0: Projected Bias Current

00 = 1.25uA (smallest)

01 = 2.5uA

10 = 5uA

11 = 10uA

D2H		ProxSense Module Settings 1 (PROX_SETTINGS1)							
		Bit	7	6	5	4	3	2	1
Access	Value	PROJ	ALT_BASE	Turbo_Mode	HC	ND	ND_TRIM0	ND_TRIM0	ND_TRIM0
R/W	Default	0	0	0	0	0	0	0	0

[D2] PROX_SETTINGS1



Bit 7: PROJ: Use the IQS253 in projected mode. This setting can only be enabled in the SETUP communications window. Alternatively, us the FG option.

0 = IQS253 in Self Capacitive sensing mode

1 = IQS253 in Projected Capacitive sensing mode

Bit 6: ALT_BASE: Set this bit to choose the alternative base values

0 = Normal base values

1 = Alternative base values

Bit 5: Turbo_Mode: Enable the DYCAL Turbo functionality (If DYCAL is enabled). By enabling this bit, the device will drastically decrease the time to detect users proximity and touch events.

0 = Normal

1 = Enable Turbo Mode

Bit 4: HC: Halt charges. The device will not perform capacitive sensing charge transfers and thus not be able to detect any user events.

0 = Charge transfers occur normally

1 = No charge transfers occur

Bit 3: ND: Noise Detection Enable. This setting is used to enable the on-chip noise detection circuitry. With noise detected, the noise affected samples will be ignored, and have no effect on the Prox, touch or LTA calculations. The NOISE bit will appropriately be set as indication of the noise status.

0 = Disable noise detection

1 = Enable noise detection

Bit 2-0: ND_TRIM2:ND_TRIM0: ND Trim values

000 = 19.1mV

001 = 9.65mV

010 = 0mV

011 = -10mV

100 = -19.1mV

101 = -29.8mV

110 = -40.9mV

111 = -57.4mV

D3H		ProxSense Module Settings 2 (PROX_SETTINGS2)							
		Bit	7	6	5	4	3	2	1
Access	Value	ACK_ RESET	COMMS_ WDT_ DISABLE	FORCE_ HALT	ACF_ DISABLE	TIME_ OUT_ DISABLE	EVENT_ MODE_ DISABLE	HALT1	HALT0
R/W	Default	0 (W)	0	0	0	0	0	0	0

[D3H] PROX_SETTINGS2

Bit 7: ACK_RESET: Acknowledge SHOW_RESET.

0 = Nothing

1 = Clear the SHOW_RESET flag (send only once)

Bit 6: WDT_DISABLE: Device watchdog timer (WDT) disable.



0 = Enabled

1 = Disabled

Bit 5: FORCE_HALT: The LTA is halted by setting this bit. It will only be allowed to adapt to the environment once it is cleared.

0 = LTA adapts to environment until actuation detected.

1 = Halt LTA.

Bit 4: ACF_DISABLE: Disable the AC Filter employed on the Counts (CS).

0 = Enable AC filter.

1 = Disable AC filter.

Bit 3: TIME_OUT_DISABLE: Enable I²C communication timeout. This bit will enable the IC to resume charge transfers if communication does not commence within 20ms of the RDY indicating that data is ready.

0 = Disable time-out.

1 = Enable time-out.

Bit 2: EVENT_MODE_DISABLE: Enable the IC to stream data continuously.

0 = I²C Communication will only occur if an event occur (events defined in EVENT_MODE_MASK byte)

1 = Continuous streaming mode

Bit 1-0: HALT1:HALT0: LTA halt timings.

00 = 20s

01 = 40s

10 = Never

11 = Always

D4H		ProxSense Module Settings 3 (PROX_SETTINGS3)							
		Bit	7	6	5	4	3	2	1
Access	Value			LTA_ ADAPT1	LTA_ ADAPT0		PROX_ DEBOUNCE	XFER_ FREQ1	XFER_ FREQ0
R/W	Default							0	1

[D4H] PROX_SETTINGS3

Bit 7-6: Unused

Bit 5-4: LTA_ADAPT: Rate at which LTA adapts to CS when no actuation is detected (non- TM mode).

00 = 3.13% (fastest)

01 = 1.56%

10 = 0.78%

11 = 0.39% (slowest)

Bit 3: Unused

Bit 2: PROX_DEBOUNCE: Number of consecutive CS samples required exceeding proximity threshold to detect a proximity event.

0 = 6

1 = 4

Bit 1-0: XFER_FREQ1:XFER_FREQ0: Charge transfer frequency.



- 00 = 1MHz
- 01 = 500kHz
- 10 = 250kHz
- 11 = 125kHz

The charge transfer frequency is a very important parameter. Dependant on the design application, the device frequency must be optimised. For example, if keys are to be used in an environment where steam or water droplets could form on the keys, a higher transfer frequency improves immunity. Also, if a sensor electrode is a very large object/size, then a slower frequency must be selected since the capacitance of the sensor is large, and a slower frequency is required to allow effective capacitive sensing on the sensor.

D5H		Active Channels (ACTIVE_CHAN)							
		Bit	7	6	5	4	3	2	1
Access		Value					CH2	CH1	CH0
R/W		Default					1	1	1

[D5H] ACTIVE_CHAN

Each channel can be individually disabled in this register.

Bit 7-3: Unused

Bit 2: CH2: Setting this bit will disable the channel

0 = Active / Charging

1 = Inactive / Not charging

Bit 1: CH1: Setting this bit will disable the channel

0 = Active / Charging

1 = Inactive / Not charging

Bit 0: CH0: Setting this bit will disable the channel

0 = Active / Charging

1 = Inactive / Not charging

D6H		Low Power Settings (LOW_POWER)								
		Bit	7	6	5	4	3	2	1	0
Access		Value	LP7	LP6	LP5	LP4	LP3	LP2	LP1	LP0
R/W		Default	Normal Power default (00H). See Note below.							
		Note	Custom value between 1 and 256 value x 16ms LP time							

[D6H] LP_PERIOD

Byte indicates the sleep time between a burst of conversions. Default (00H), a channel is charged every 27ms. The LP time can be set to any custom value between 1 and 256. The time between the conversions will then be the value x 16ms. (NOTE: CX2 does a dummy conversion before the burst of the active channels are executed.)

D7H		DYCAL Specific Settings (DYCAL_SETTINGS)							
		Bit	7	6	5	4	3	2	1
Access	Value	250ms_	ALWAYS_	BETA_	BETA_	BETA_	OUTPUT_	REL_	REL_
		DELAY_	HALT_	TM_	TM_	TM_IN	ON_	THR1	THR0
R/W		TM	DYCAL	OUT1	OUT0		TOUCH		
	Default	0	0	0	0	0	0	0	0



[D7H] DYCAL_SETTINGS

Byte indicates which channels are actively charged.

Bit 7: 250ms_DELAY_TM: A 250ms delay is applied on the LTA when a touch is detected, before the LTA is reseeded to the LTA-TOUCH_THR

0 = Enabled

1 = Disabled

Bit 6: ALWAYS_HALT_DYCAL: Always halt LTA in TM if CS exceeds LTA by 16 (Self) or if CS is lower than LTA by 16 (projected)

0 = Halting of LTA in TM according to HALT1:HALT0 settings

1 = Always halt LTA if above condition is met

Bit 5-4: LTA_ADAPT_IN: Rate at which LTA adapts after reseed when heading towards the CS in TM

00 = 1.56%

01 = 6.25% (fastest)

10 = 3.13%

11 = 0.78% (slowest)

Bit 3: LTA_ADAPT_OUT: Rate at which LTA adapts after its reached CS, when CS is heading out of TM.

0 = 0.10% (fastest)

1 = 0.01% (slowest)

Bit 2: OUTPUT_ON_TOUCH: Setting this bit will enable the DYCAL output to change with touch actuation.

0 = DYCAL on Proximity

1 = DYCAL on Touch

Bit 1-0: RELEASE_THR1:RELEASE_THR0: Release threshold with which CS should exceed LTA for LTA to reseed back to non-TM.

00 = 75%

01 = 50%

10 = 87.5%

11 = 100%

D8H		DYCAL Channels Enable (DYCAL_CHANS)							
		Bit	7	6	5	4	3	2	1
Access						BLOCK_ON_CH1_ENABLE	CH2	CH1	CH0
R/W						0	1	1	1

[D8H] DYCAL enable and Block channel enable (DYCAL_CHANS)

Channels are default configured as DYCAL channels. Clearing a channel bit, will make it a direct output channel.

Bit 7-4: Unused

Bit 3: CH1_BLOCK: Setting this bit will make channel 1 a block channel

0 = Normal output

1 = CH1 will block the output of the other channels if actuated

Bit 2: CH2: Clearing this bit, will make the channel a direct output channel

0 = Direct Output channel



1 = DYCAL channel

Bit 1: CH1: Clearing this bit, will make the channel a direct output channel

0 = Direct Output channel

1 = DYCAL channel

Bit 0: CH0: Clearing this bit, will make the channel a direct output channel

0 = Direct Output channel

1 = DYCAL channel

D9H		EVENT MODE MASK (EVENT_MASK)							
		Bit	7	6	5	4	3	2	1
Access				ATI	DYCAL	BOOLEAN	NOISE	TOUCH	PROX
R/W				1	1	1	1	1	1

[D9H] Event Mode mask (EVENT_MASK)

Bit 7-6: Unused

Bit 5: ATI: A communication event will occur if an ATI or re-ATI occurs.

0 = Communication event will not occur

1 = Communication event will occur

Bit 4: DYCAL: A communication event will occur if a DYCAL state change occurs.

0 = Communication event will not occur

1 = Communication event will occur

Bit 3: BOOLEAN: A communication event will occur if a Boolean state change occurs.

0 = Communication event will not occur

1 = Communication event will occur

Bit 2: NOISE: A communication event will occur if noise is detected.

0 = Communication event will not occur

1 = Communication event will occur

Bit 1: TOUCH: A communication event will occur if a proximity state change occurs. Should only be used if a channel is in direct mode.

0 = Communication event will not occur

1 = Communication event will occur

Bit 0: PROXIMITY: A communication event will occur if a proximity state change occurs. Should only be used if a channel is in direct mode.

0 = Communication event will not occur

1 = Communication event will occur

DAH		Boolean Settings (BOOLEAN_SETTINGS)							
		Bit	7	6	5	4	3	2	1
Access						BOOL_AND_OR	MASK_CH2	MASK_CH1	MASK_CH0
R/W						0	0	0	0

[DAH] BOOLEAN_SETTINGS





Bit 7-4: Unused

Bit 3: BOOLEAN_AND_OR: Boolean AND operation on the channels chosen to perform this action on

0 = Boolean AND operation

1 = Boolean OR operation

Bit 2: CH2: Use this channel in the Boolean operation

0 = No

1 = Yes

Bit 1: CH1: Use this channel in the Boolean operation

0 = No

1 = Yes

Bit 0: CH0: Use this channel in the Boolean operation

0 = No

1 = Yes

DBH		Boolean NOT Mask (BOOLEAN_NOT)							
		Bit	7	6	5	4	3	2	1
Access							NOT_CH2	NOT_CH1	NOT_CH0
R/W							0	0	0

[DBH] BOOLEAN_NOT

Bit 7-3: Unused

Bit 2: CH2: Invert this channels polarity (NOT operation)

0 = No action

1 = NOT Channel (Invert channel polarity)

Bit 1: CH1: Invert this channels polarity (NOT operation)

0 = No action

1 = NOT Channel (Invert channel polarity)

Bit 0: CH0: Invert this channels polarity (NOT operation)

0 = No action

1 = NOT Channel (Invert channel polarity)

DDH		DEFAULT_COMMS_POINTER								
		Bit	7	6	5	4	3	2	1	0
Access										
R/W		Default 10H (Beginning of Device Specific Data)								

[DDH] Default Comms Pointer

The value stored in this register will be loaded into the Comms Pointer at the start of a communication window. For example, if the design only requires the Proximity Status information each cycle, then the Default Comms Pointer can be set to ADDRESS 31H. This would mean that at the start of each communication window, the comms pointer would already be set to the Proximity Status register, simply allowing a READ to retrieve the data, without the need of setting up the address.

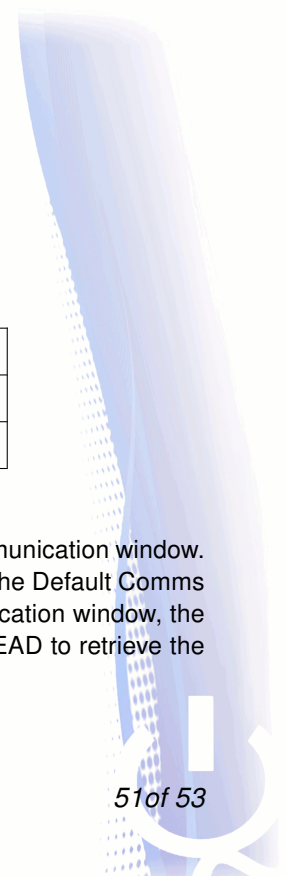



B.2 General Implementation Hints

When implementing the communication interface with the IQS253, please refer to the IQS253 datasheet for a detailed description of the I²C communication. This section contains some general guidelines and hints regarding the communication interface.

B.2.1 I²C Communication window

When communicating via I²C, the communication window will automatically close when a STOP bit is received by the IQS253. The IQS253 will then proceed to start with a new conversion and the READY line will be pulled low until the new conversion is complete. Note that there is no command via I²C to initiate a new conversion. To perform multiple read and write commands, the repeated start function of the I²C must be used to stack the commands together.

B.3 Startup Procedure

After sending initial settings to the IQS253, it is important to execute a reseed. It is suggested to execute an estimated 24 conversions after initial settings before calling for a reseed, to allow the system to stabilise.

B.4 General I²C Hints

B.4.1 I²C Pull-up resistors

When implementing I²C it is important to remember the pull-up resistors on the data and clock lines. 4.7k is recommended, but for lower clock speeds bigger pull-ups will reduce power consumption. The RDY line is SW OD and also requires a pull up resistor (typical 10k).





References

- [1] *AZD008 - Design Guidelines for Touch Pads.* Azoteq, 2011.
- [2] *AZD013 - Calculating Rx for improving ESD ratings.* Azoteq, 2008.
- [3] *AZD015 - RF Immunity Guidelines.* Azoteq, 2011.
- [4] *AZD051 - Electrical Fast Transient Burst Guidelines.* Azoteq, 2011.
- [5] *AZD052 - Conducted RF Immunity Guidelines.* Azoteq, 2011.
- [6] *AZD062 - IQS253 Communication Interface Guideline.* Azoteq, 2012.

Mouser Electronics

Authorized Distributor

Click to View Pricing, Inventory, Delivery & Lifecycle Information:

[Azoteq:](#)

[IQS253MSR](#)