

LITEON

LTP- 1257AA/1357AA SERIES 1457A/1557A

1.2" 5x7 SINGLE COLOR & MULTICOLOR
DOT MATRIX DISPLAYS

LITE-ON INC

31E D 5536367 0002511 1 LTN

T-41-35

FEATURES

- 1.2" INCH (30.48mm) MATRIX HEIGHT.
- LOW POWER REQUIREMENT.
- HIGH CONTRAST.
- HIGH BRIGHTNESS.
- SINGLE PLANE, WIDE VIEWING ANGLE.
- SOLID STATE RELIABILITY.
- 5 x 7 ARRAY WITH X-Y SELECT.
- COMPATIBLE WITH USASCII AND EBCDIC CODES.
- STACKABLE HORIZONTALLY.
- CHOICE OF TWO MATRIX ORIENTATION CATHODE ROW OR CATHODE COLUMN.
- EASY MOUNTING ON P.C. BOARD.
- CATEGORIZED FOR LUMINOUS INTENSITY.
- SINGLE COLOR DISPLAYS HAVE THE CHOICE OF FOUR BRIGHT COLORS-GREEN / YELLOW / ORANGE / HIGH EFFICIENCY RED.
- MULTICOLOR DISPLAYS ARE APPLICABLE TO THREE BRIGHT COLORS: GREEN, ORANGE AND YELLOW (GREEN AND ORANGE MIXED)

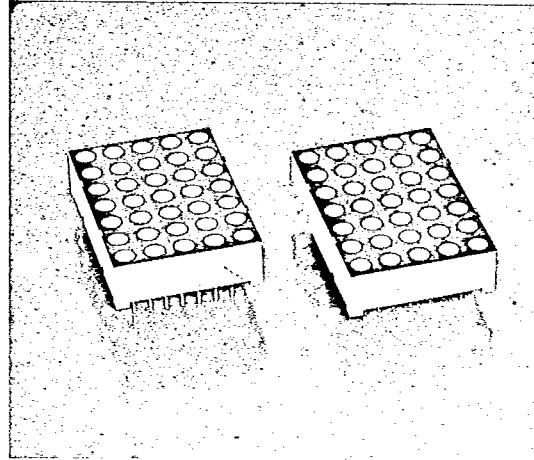

DESCRIPTION

The LTP-1 x 57A series are 1.2 inch (30.48mm) matrix height 5 x 7 dot matrix displays.

The LTP-1257AA/1357AA are multicolor applicable displays. The multicolor displays have gray face and white dot color.

The LTP-1457A/1557A series are single color displays. The green, yellow and orange displays have gray face and white dot color. The high efficiency red displays have red face and red dot color.

The green series devices utilize LED chips which are made from GaP on a transparent GaP substrate.

The yellow, orange and high efficiency red series devices utilize LED chips which are made from GaAsP on a transparent GaP substrate.

DEVICES

PART NO. LTP-					DESCRIPTION	PACKAGE DIMENSION	INTERNAL CIRCUIT DIAGRAM
GREEN	YELLOW	ORANGE	HI.-EFF. RED	MULTI-COLOR			
—	—	—	—	1257AA	Anode Column, Cathode Row	A	A
—	—	—	—	1357AA	Cathode Column, Anode Row	A	B
1457AG	1457AY	1457AE	1457AHR	—	Anode Column, Cathode Row	B	C
1557AG	1557AY	1557AE	1557AHR	—	Cathode Column, Anode Row	B	D

PACKAGE DIMENSIONS

A. LTP-1257AA/1357AA

B. LTP-1457A/1557A

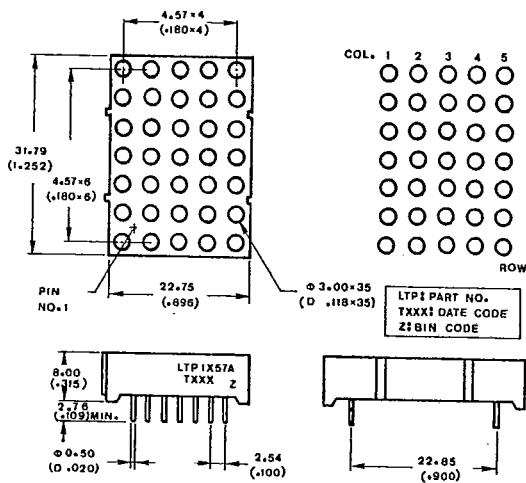
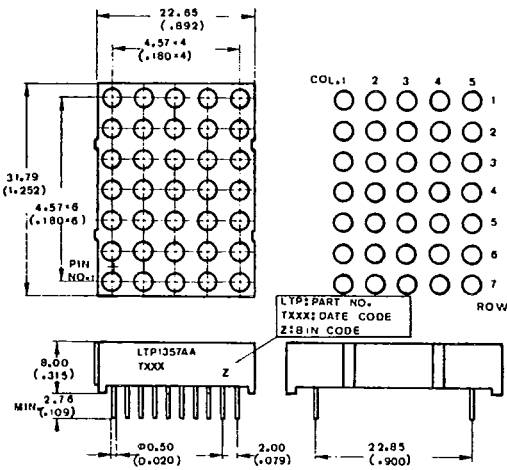

NOTE: All dimensions are in millimeters (inches) tolerance are:

1. Lead length (from seating plane): minimum value $\frac{+1.00}{-0.000}$ mm $\frac{+0.040''}{-0.000''}$ 2. $\frac{\pm 0.25\text{mm}}{(0.010'')}$ unless otherwise noted.

T-41-35

PIN CONNECTION

PIN NO.	CONNECTION			
	A LTP-1257AA	B LTP-1357AA	C LTP-1457A	D LTP-1557A
1	Cathode Row 7 Green	Anode Row 7 Green	Cathode Row 5	Anode Row 5
2	Cathode Row 7 Orange	Anode Row 7 Orange	Cathode Row 7	Anode Row 7
3	Anode Column 1	Cathode Column 1	Anode Column 2	Cathode Column 2
4	Anode Column 2	Cathode Column 2	Anode Column 3*1	Cathode Column 3*1
5	Anode Column 3	Cathode Column 3	Cathode Row 4*2	Anode Row 4*2
6	Anode Column 4	Cathode Column 4	Anode Column 5	Cathode Column 5
7	Anode Column 5	Cathode Column 5	Cathode Row 6	Anode Row 6
8	Cathode Row 6 Green	Anode Row 6 Green	Cathode Row 3	Anode Row 3
9	Cathode Row 6 Orange	Anode Row 6 Orange	Cathode Row 1	Anode Row 1
10	No Connection	No Connection	Anode Column 4	Cathode Column 4
11	Cathode Row 5 Green	Anode Row 5 Green	Anode Column 3*1	Cathode Column 3*1
12	Cathode Row 5 Orange	Anode Row 5 Orange	Cathode Row 4*2	Anode Row 4*2
13	Cathode Row 4 Green	Anode Row 4 Green	Anode Column 1	Cathode Column 1
14	Cathode Row 4 Orange	Anode Row 4 Orange	Cathode Row 2	Anode Row 2
15	Cathode Row 3 Green	Anode Row 3 Green		
16	Cathode Row 3 Orange	Anode Row 3 Orange		
17	Cathode Row 2 Green	Anode Row 2 Green		
18	Cathode Row 2 Orange	Anode Row 2 Orange		
19	Cathode Row 1 Green	Anode Row 1 Green		
20	Cathode Row 1 Orange	Anode Row 1 Orange		

NOTES: 1. Pin 4 & 11 are internally connected.
2. Pin 5 & 12 are internally connected.

INTERNAL CIRCUIT DIAGRAM

A. LTP-1257AA

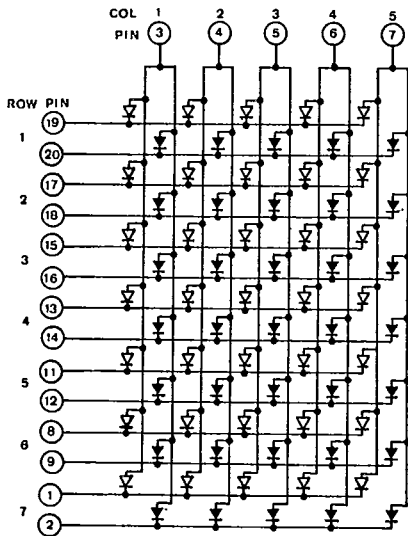

B. LTP-1357AA

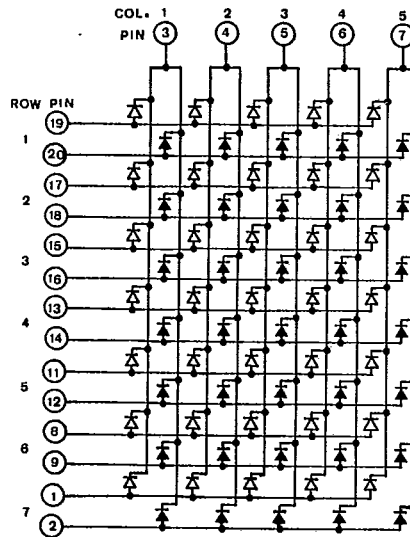

NOTE: The sign " —▷ " stands for GREEN color chips
The sign " —▷ " stands for ORANGE color chips

T-41-35

C. LTP-1457A

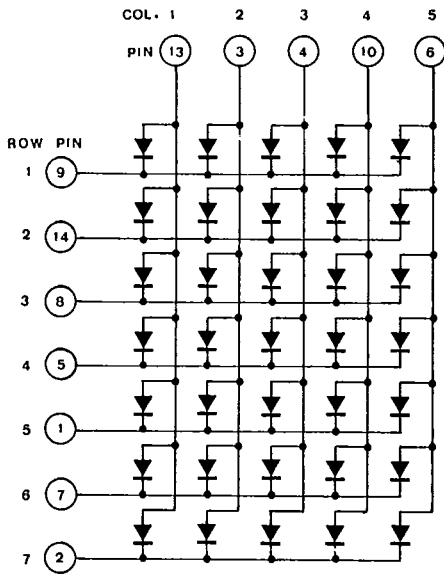

D. LTP-1557A

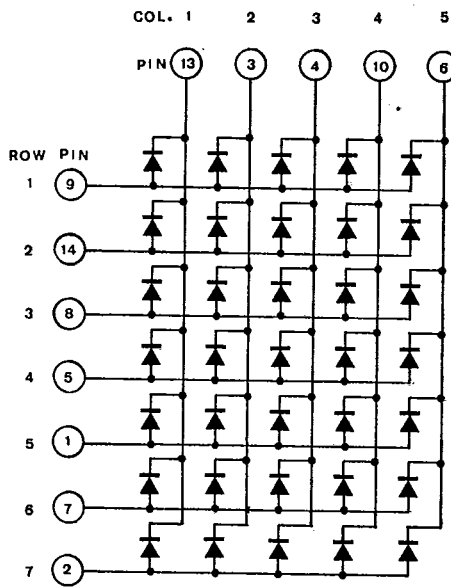

ABSOLUTE MAXIMUM RATINGS AT TA = 25°C

PARAMETER	GREEN	YELLOW	ORANGE	HI-EFF RED	UNIT
Power Dissipation Per Dot	75	60	75	75	mW
Peak Forward Current Per Dot (1/10 Duty Cycle, 0.1ms Pulse Width)	100	80	100	100	mA
Continuous Forward Current Per Dot	25	20	25	25	mA
Derating Linear From 25°C Per Dot	0.3	0.24	0.3	0.3	mA/°C
Reverse Voltage Per Dot	5	5	5	5	V
Operating Temperature Range	-25°C to +85°C				
Storage Temperature Range	-25°C to +85°C				
Solder Temperature 1/16 inch Below Seating Plane for 3 Sec. at 260°C					



ELECTRICAL/OPTICAL CHARACTERISTICS AT $T_A = 25^\circ\text{C}$
LTP-1257AA/1357AA (GREEN) & LTP-1457AG/1557AG

PARAMETER	SYMBOL	MIN.	TYP.	MAX.	UNIT	TEST CONDITION
Average Luminous Intensity	I_v	800	3000		μcd	$I_p = 48 \text{ mA}$ 1/8 DUTY
Peak Emission Wavelength	λ_p		565		nm	$I_F = 20 \text{ mA}$
Spectral Line Half-Width	$\Delta\lambda$		30		nm	$I_F = 20 \text{ mA}$
Forward Voltage, any Dot	V_F		2.1	2.8	V	$I_F = 20 \text{ mA}$
Reverse Current, any Dot	I_R			100	μA	$V_R = 5 \text{ V}$
Luminous Intensity Matching Ratio	$I_v\text{-m}$			2:1		$I_F = 20 \text{ mA}$

TYPICAL ELECTRICAL/OPTICAL CHARACTERISTIC CURVES

(25°C Ambient Temperature Unless Otherwise Noted)

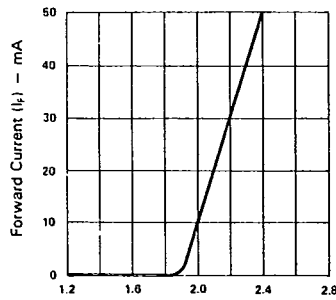

Fig. 1 FORWARD CURRENT vs. FORWARD VOLTAGE.

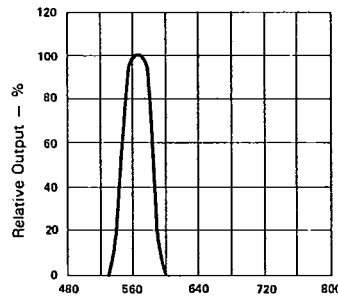

Fig. 2 SPECTRAL RESPONSE.

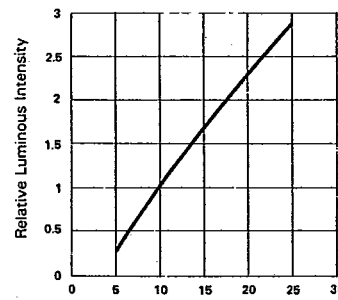

Fig. 3 RELATIVE LUMINOUS INTENSITY vs. FORWARD CURRENT (PER SEGMENT).

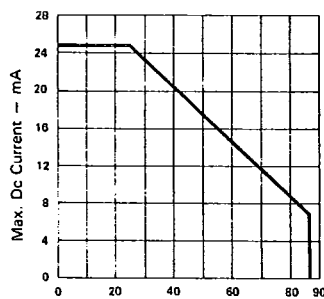

Fig. 4 MAX. ALLOWABLE DC CURRENT PER SEG. vs. AMBIENT TEMPERATURE.

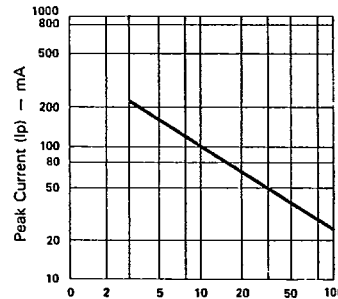

Fig. 5 MAX. PEAK CURRENT vs. DUTY CYCLE. % (REFRESH RATE - $F = 1 \text{ KHz}$)

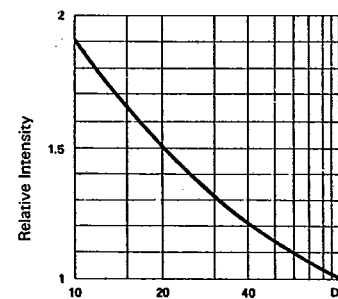

Fig. 6 LUMINOUS INTENSITY vs. DUTY CYCLE. % (AVERAGE $I_F = 10 \text{ mA}$ PER SEG.)

ELECTRICAL/OPTICAL CHARACTERISTICS AT TA = 25°C
LTP-1457AY/1557AY

PARAMETER	SYMBOL	MIN.	TYP.	MAX.	UNIT	TEST CONDITION
Average Luminous Intensity *1,2	I_v	800	3000		μcd	$I_p = 48 \text{ mA}$ 1/8 DUTY
Peak Emission Wavelength	λ_p		585		nm	$I_F = 20 \text{ mA}$
Spectral Line Half-Width	$\Delta\lambda$		35		nm	$I_F = 20 \text{ mA}$
Forward Voltage, any Dot	V_F		2.1	2.8	V	$I_F = 20 \text{ mA}$
Reverse Current, any Dot	I_R			100	μA	$V_R = 5 \text{ V}$
Luminous Intensity Matching Ratio	$I_v\text{-m}$			2:1		$I_F = 20 \text{ mA}$

TYPICAL ELECTRICAL/OPTICAL CHARACTERISTIC CURVES

(25° Ambient Temperature Unless Otherwise Noted)

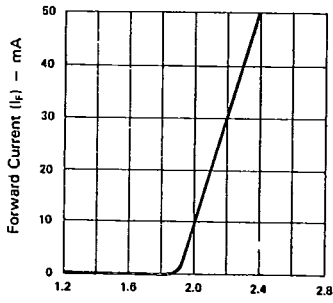

Fig. 1 FORWARD CURRENT Vs. FORWARD VOLTAGE.

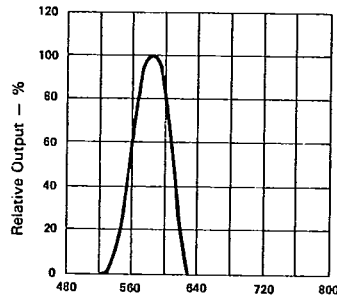

Fig. 2 SPECTRAL RESPONSE.

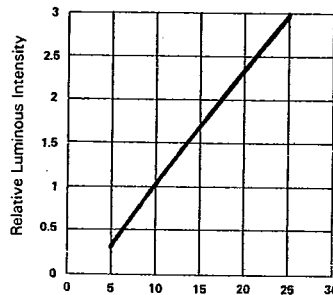

Fig. 3 RELATIVE LUMINOUS INTENSITY Vs. FORWARD CURRENT (PER SEGMENT).

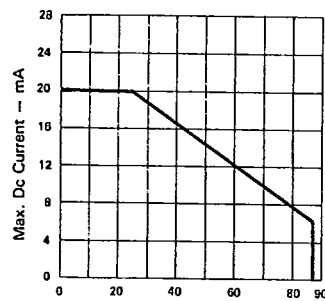

Fig. 4 MAX. ALLOWABLE DC CURRENT PER SEG. Vs AMBIENT TEMPERATURE.

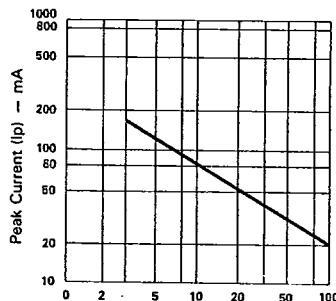

Fig. 5 MAX. PEAK CURRENT Vs. DUTY CYCLE% (REFRESH RATE - F = 1 KHz)

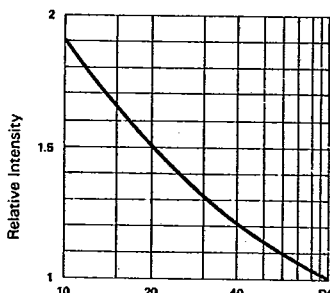

Fig. 6 LUMINOUS INTENSITY Vs. DUTY CYCLE% (AVERAGE $I_f = 10 \text{ mA}$ PER SEG.)



ELECTRICAL/OPTICAL CHARACTERISTICS AT TA = 25°C
LTP-1257AA/1357A (ORANGE) & LTP-1457AE/1557AE

PARAMETER	SYMBOL	MIN.	TYP.	MAX.	UNIT	TEST CONDITION
Average Luminous Intensity	I_v	800	3000		μcd	$I_p = 48 \text{ mA}$ 1/8 DUTY
Peak Emission Wavelength	λ_p		630		nm	$I_F = 20 \text{ mA}$
Spectral Line Half-Width	$\Delta\lambda$		40		nm	$I_F = 20 \text{ mA}$
Forward Voltage, any Dot	V_F		2.1	2.8	V	$I_F = 20 \text{ mA}$
Reverse Current, any Dot	I_R			100	μA	$V_R = 5\text{V}$
Luminous Intensity Matching Ratio	$I_v\text{-m}$			2:1		$I_F = 20 \text{ mA}$

TYPICAL ELECTRICAL/OPTICAL CHARACTERISTIC CURVES
 (25°C Ambient Temperature Unless Otherwise Noted)

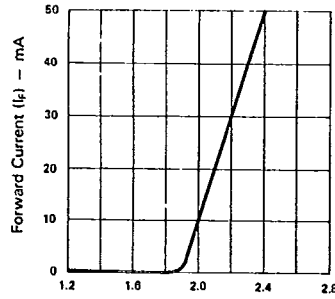

Forward Voltage (V_f) - Volts
 Fig. 1 FORWARD CURRENT Vs. FORWARD VOLTAGE.

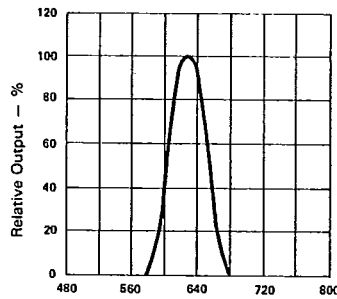

Wavelength (λ) - nm.
 Fig. 2 SPECTRAL RESPONSE.

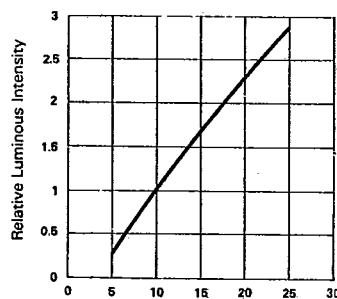

Forward Current (I_f) - mA
 Fig. 3 RELATIVE LUMINOUS INTENSITY Vs. FORWARD CURRENT (PER SEGMENT).

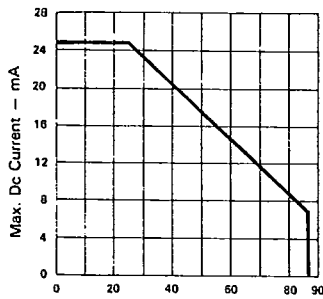

Ambient Temperature (T_a) - °C
 Fig. 4 MAX. ALLOWABLE DC CURRENT PER SEG. Vs AMBIENT TEMPERATURE.

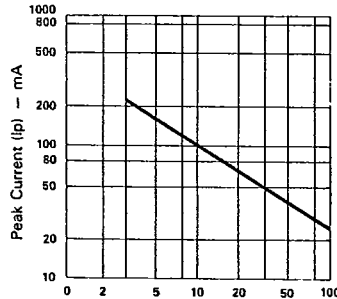

Duty Cycle %
 Fig. 5 MAX. PEAK CURRENT Vs. DUTY CYCLE.% (REFRESH RATE - F = 1 KHz)

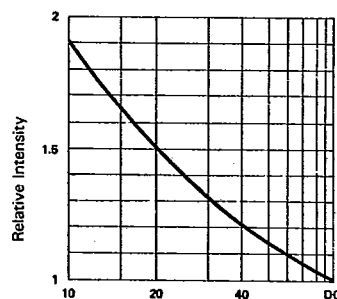

Duty Cycle %
 Fig. 6 LUMINOUS INTENSITY Vs. DUTY CYCLE% (AVERAGE $I_f = 10\text{mA}$ PER SEG.)

ELECTRICAL/OPTICAL CHARACTERISTICS AT $T_A = 25^\circ\text{C}$
LTP-1457AHR/1557AHR

PARAMETER	SYMBOL	MIN.	TYP.	MAX.	UNIT	TEST CONDITION
Average Luminous Intensity	I_v	800	3000		μcd	$I_p = 48 \text{ mA}$ 1/8 DUTY
Peak Emission Wavelength	λ_p		635		nm	$I_F = 20 \text{ mA}$
Spectral Line Half-Width	$\Delta\lambda$		40		nm	$I_F = 20 \text{ mA}$
Forward Voltage, any Dot	V_F		2.1	2.8	V	$I_F = 20 \text{ mA}$
Reverse Current, any Dot	I_R			100	μA	$V_R = 5 \text{ V}$
Luminous Intensity Matching Ratio	$I_v\text{-m}$			2:1		$I_F = 20 \text{ mA}$

TYPICAL ELECTRICAL/OPTICAL CHARACTERISTIC CURVES
 (25° Ambient Temperature Unless Otherwise Noted)

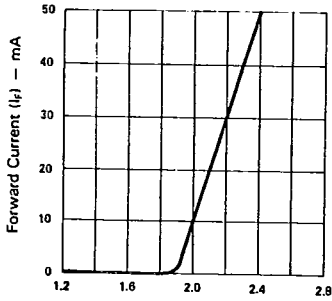

Fig. 1 FORWARD CURRENT Vs. FORWARD VOLTAGE.

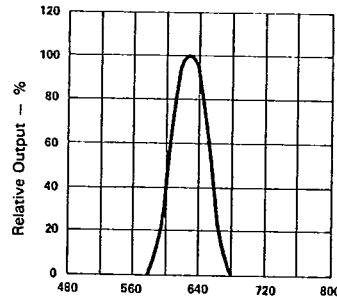

Fig. 2 SPECTRAL RESPONSE.

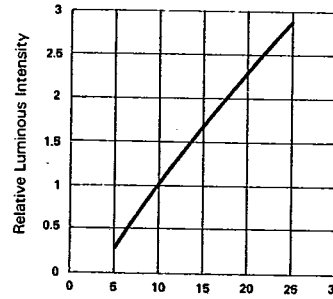

Fig. 3 RELATIVE LUMINOUS INTENSITY Vs. FORWARD CURRENT (PER SEGMENT).

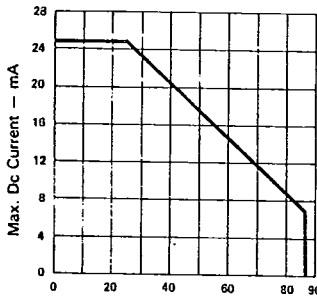

Fig. 4 MAX. ALLOWABLE DC CURRENT PER SEG. Vs AMBIENT TEMPERATURE.

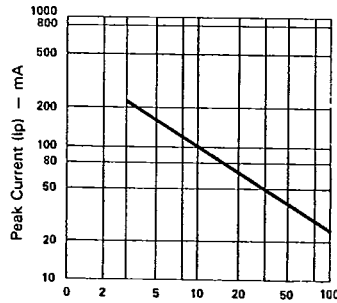

Fig. 5 MAX. PEAK CURRENT Vs. DUTY CYCLE % (REFRESH RATE - $F = 1 \text{ KHz}$)

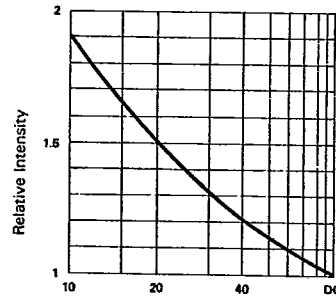

Fig. 6 LUMINOUS INTENSITY Vs. DUTY CYCLE % (AVERAGE $I_F = 10 \text{ mA PER SEG.}$)

PACKAGING

T-90-20

Reel Packaging (Axial Lead Units)

DEVICE TYPE	COMPONENT SPACE (MM) "A"	TAPE SPACE (MM) "B"	REEL DIA (MM) "D"	QUANTITY (EA)		CARTON	
				REEL	CARTON	SIZE (MM)	WEIGHT (KG)
DO-41 DO-41L	5±0.5	52.4±1.5	326~336	5000	20K	355 x 355 x 355	10.5
DO-201AD	10±0.5	52.4±1.5	326~336	1200	4.8K	355 x 355 x 355	9.0
P6(Aleg)	10±0.5	52.4±1.5	326~336	700	2.8K	355 x 355 x 355	8.8

The C dimension of Fig. 3 is between 3.17m.m. and 635mm greater than the length of the component involved.

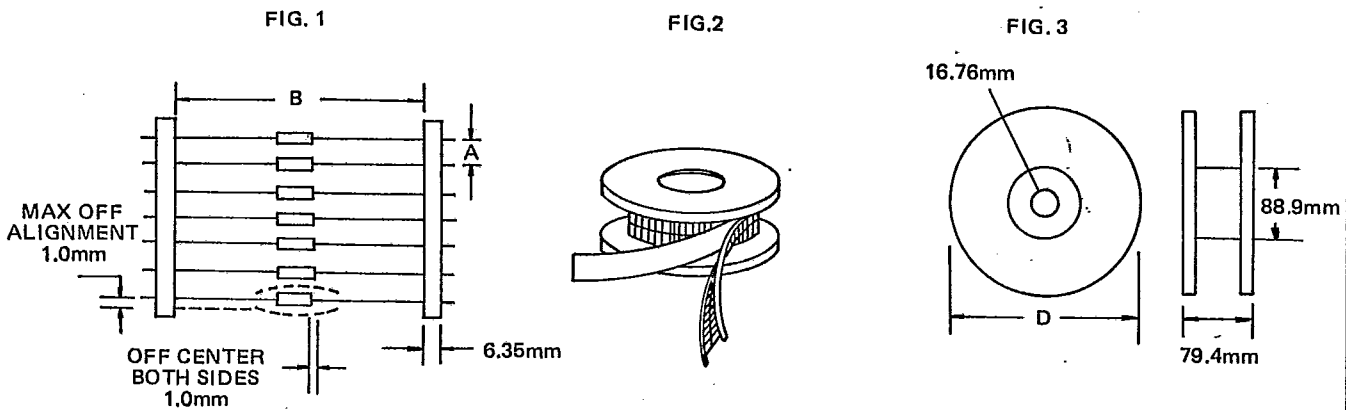

Bulk Packaging (Axial Lead Devices and Bridge Rectifiers)

DEVICE TYPE	PACKAGING SIZE (MM)		QUANTITY (EA)		APPROX GROSS WEIGHT (KG)	
	BOX	CARTON	BOX	CARTON	BOX	CARTON
DO-41 DO-41L	196 x 84 x 20	450 x 210 x 250	1000	50K	0.38	20
DO-201AD	305 x 93 x 59	355 x 355 x 355	1000	20K	1.35	28
P6(Aleg)	305 x 93 x 59	355 x 355 x 355	500	10K	1.2	24.5
PBM	357 x 125 x 60	530 x 360 x 340	1000	20K	1.5	32.3
PBDF	495 x 155 x 145	500 x 325 x 305	5000	20K	5.1	21.5
PBP	357 x 125 x 60	530 x 360 x 340	500	10K	1.5	31.5
PBL	375 x 220 x 155	470 x 385 x 455	1000	5K	5.7	30.5
PBPC-6	357 x 125 x 60	560 x 360 x 340	250	5K	1.1	22
PBPC-8	357 x 125 x 60	560 x 360 x 340	250	5K	1.7	35
KBPC	375 x 220 x 365	470 x 390 x 385	500	1K	15.1	31.5
KBPC-W	375 x 220 x 365	470 x 390 x 385	500	1K	14.5	30.0

AMMO BOX PACKAGING

BOX SIZE

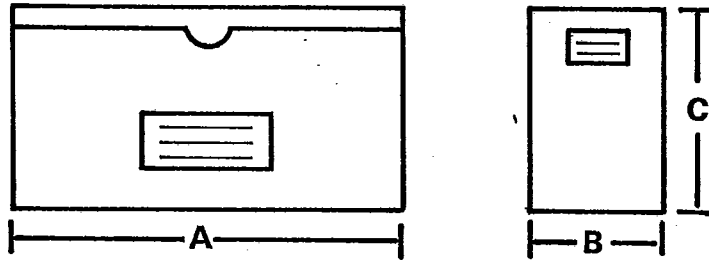

Unit:m. m.

Packaging	Products Outline	Dimension *A*	Dimension *B*	Dimension *C*	Q'ty per BOX
26MM Horizontal Ammo Pack	DO-41	255	50	95	3K
	DO-41L(0.6mm Lead)				3K
52MM Horizontal Ammo Pack	DO-41 and DO-41L	250	75	92	3K
	DO 201AD				0.8K

CARTON SIZE

Unit:m. m.

Packaging	Products Outline	length	Width	High	Q'ty Per Carton
26MM Horizontal Ammo Pack	DO-41	330	310	268	42K
	DO-41L(0.6mm Lead)				
52MM Horizontal Ammo Pack	DO-41 and DO-41L	355	355	340	48K
	DO 201AD				12K

PREFORMED LEAD DRAWING

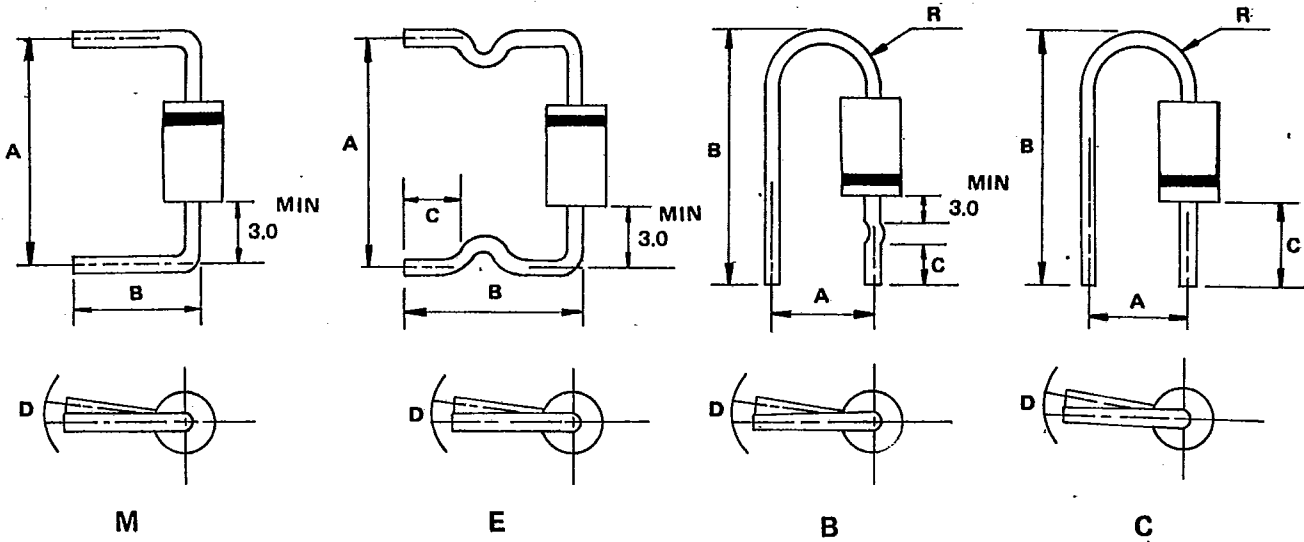

Case type	Preformed type	A (mm)		B (mm)		C (mm)		D (mm)		R (mm)	
		range	tolerance	range	tolerance	range	tolerance	range	tolerance	range	tolerance
D041	M	9.0-20.0	1.0	8.0-22.0	±0.5	-	-	1.5	max	-	-
	E	11.0-20.0	±1.0	11.0-16.0	±1.0	4.0-5.0	±0.5	1.5	max	-	-
	B	7.5	±0.5	19.0-22.0	±0.5	7.5	±0.5	1.5	max	2.5-4.0	Typ
	C	4.5	±0.8	18.0-19.0	±0.5	9.0	±0.5	1.5	max	2.5-4.0	Typ
D0201AD	M	15.0-20.0	±1.0	8.0-22.0	±1.0	-	-	2.0	max	-	-
	E	15.0-20.0	±1.0	10.0-22.0	±1.0	3.0-15.0	±0.5	2.0	max	-	-
P6(Aleg)	M	15.0-20.0	±1.0	8.0-22.0	±1.0	-	-	2.0	max	-	-