

IRF9395MPbF

IRF9395MTRPbF

DirectFET™ dual P-Channel Power MOSFET ②

Typical values (unless otherwise specified)

V_{DSS}	V_{GS}	R_{DS(on)}		
-30V max	±20V max	5.3mΩ@-10V	9.0mΩ@-4.5V	
Q_{g tot}	Q_{gd}	Q_{gs2}	Q_{rr}	
32nC	15nC	3.2nC	62nC	
			Q_{oss}	
			23nC	
				V_{gs(th)}
				-1.8V

Applications

- Isolation Switch for Input Power or Battery Application

Features and Benefits

- Environmentally Friendly Product
- RoHs Compliant Containing no Lead, no Bromide and no Halogen
- Dual Common-Drain P-Channel MOSFETs Provides High Level of Integration and Very Low RDS(on)

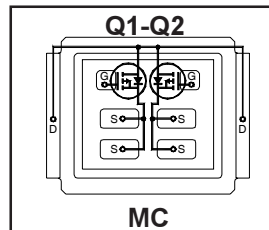

Applicable DirectFET Outline and Substrate Outline (see p.7,8 for details)①

SQ	SX	ST		MQ	MX	MT	MP	MC		
----	----	----	--	----	----	----	----	-----------	--	--

Description

The IRF9395MTRPbF combines the latest HEXFET® P-Channel Power MOSFET Silicon technology with the advanced DirectFET™ packaging to achieve the lowest on-state resistance in a package that has the footprint of a SO-8 and only 0.6 mm profile. The DirectFET package is compatible with existing layout geometries used in power applications, PCB assembly equipment and vapor phase, infra-red or convection soldering techniques, when application note AN-1035 is followed regarding the manufacturing methods and processes. The DirectFET package allows dual sided cooling to maximize thermal transfer in power systems, improving previous best thermal resistance by 80%.

Orderable part number	Package Type	Standard Pack		Note
		Form	Quantity	
IRF9395MTRPbF	DirectFET Medium Can	Tape and Reel	4800	
IRF9395MTR1PbF	DirectFET Medium Can	Tape and Reel	1000	

Absolute Maximum Ratings

	Parameter	Max.	Units
V _{DS}	Drain-to-Source Voltage	-30	V
V _{GS}	Gate-to-Source Voltage	±20	V
I _D @ T _A = 25°C	Continuous Drain Current, V _{GS} @ 10V ③	-14	A
I _D @ T _A = 70°C	Continuous Drain Current, V _{GS} @ 10V ③	-11	
I _D @ T _C = 25°C	Continuous Drain Current, V _{GS} @ 10V ④	-75	
I _{DM}	Pulsed Drain Current ⑤	-110	

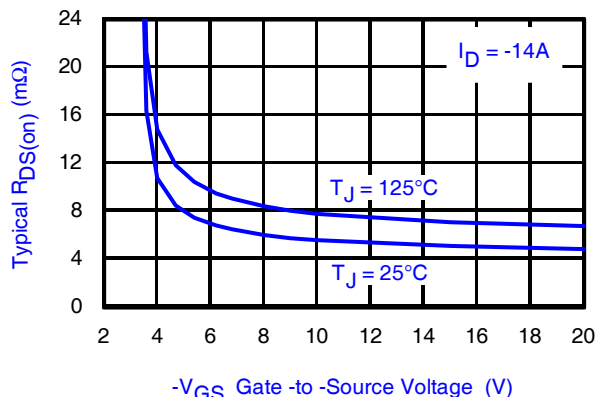

Fig 1. Typical On-Resistance vs. Gate Voltage

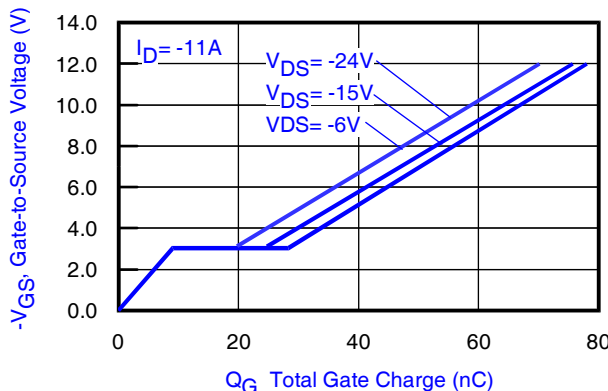

Fig 2. Typical Total Gate Charge vs. Gate-to-Source Voltage

Notes:

- ① Click on this section to link to the appropriate technical paper.
- ② Click on this section to link to the DirectFET Website.
- ③ Surface mounted on 1 in. square Cu board, steady state.

- ④ T_C measured with thermocouple mounted to top (Drain) of part.
- ⑤ Repetitive rating; pulse width limited by max. junction temperature.

Static @ T_J = 25°C (unless otherwise specified)

	Parameter	Min.	Typ.	Max.	Units	Conditions
BV _{DSS}	Drain-to-Source Breakdown Voltage	-30	—	—	V	V _{GS} = 0V, I _D = -250μA
ΔBV _{DSS} /ΔT _J	Breakdown Voltage Temp. Coefficient	—	0.012	—	mV/°C	Reference to 25°C, I _D = -1.0mA
R _{DS(on)}	Static Drain-to-Source On-Resistance	—	5.3	7.0	mΩ	V _{GS} = -10V, I _D = -14A ⑥
		—	9.0	11.9		V _{GS} = -4.5V, I _D = -11 A ⑥
V _{GS(th)}	Gate Threshold Voltage	-1.3	-1.8	-2.4	V	V _{DS} = V _{GS} , I _D = -50μA
ΔV _{GS(th)} /ΔT _J	Gate Threshold Voltage Coefficient	—	-6.1	—	mV/°C	
I _{DSS}	Drain-to-Source Leakage Current	—	—	-1.0	μA	V _{DS} = -24V, V _{GS} = 0V
		—	—	-150		V _{DS} = -24V, V _{GS} = 0V, T _J = 125°C
I _{GSS}	Gate-to-Source Forward Leakage	—	—	-100	nA	V _{GS} = -20V
	Gate-to-Source Reverse Leakage	—	—	100		V _{GS} = 20V
gfs	Forward Transconductance	40	—	—	S	V _{DS} = -15V, I _D = -11A
Q _g	Total Gate Charge	—	64	—	nC	V _{DS} = -15V, V _{GS} = -10V, I _D = -11A V _{DS} = -15V V _{GS} = -4.5V I _D = -11A See Fig.15
Q _g	Total Gate Charge	—	32	—		
Q _{gs1}	Pre- V _{th} Gate-to-Source Charge	—	6.5	—		
Q _{gs2}	Post -V _{th} Gate-to-Source Charge	—	3.2	—		
Q _{gd}	Gate-to-Drain Charge	—	15	—		
Q _{godr}	Gate Charge Overdrive	—	7.3	—		
Q _{sw}	Switch charge (Q _{gs2} + Q _{gd})	—	18.2	—		
Q _{oss}	Output Charge	—	23	—	nC	V _{DS} = -16V, V _{GS} = 0V
R _G	Gate Resistance	—	15	—	Ω	
t _{d(on)}	Turn-On Delay Time	—	16	—	ns	V _{DD} = -15V, V _{GS} = -4.5V ⑥ I _D = -11A R _G = 1.8Ω See Fig.17
t _r	Rise Time	—	142	—		
t _{d(off)}	Turn-Off Delay Time	—	76	—		
t _f	Fall Time	—	121	—		
C _{iss}	Input Capacitance	—	3241	—	pF	V _{GS} = 0V V _{DS} = -15V f = 1.0KHz
C _{oss}	Output Capacitance	—	820	—		
C _{rss}	Reverse Transfer Capacitance	—	466	—		

Diode Characteristics

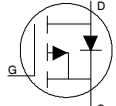
	Parameter	Min.	Typ.	Max.	Units	Conditions
I _S	Continuous Source Current (Body Diode)	—	—	-57	A	MOSFET symbol showing the integral reverse p-n junction diode. 
I _{SM}	Pulsed Source Current (Body Diode) ⑤	—	—	-110		
V _{SD}	Diode Forward Voltage	—	—	-1.2	V	T _J = 25°C, I _S = -11A, V _{GS} = 0V ⑥
t _{rr}	Reverse Recovery Time	—	43	65	ns	T _J = 25°C, I _F = -11A, V _{DD} = -15V
Q _{rr}	Reverse Recovery Charge	—	62	93	nC	di/dt = 260A/μs ⑥

Notes:

⑥ Pulse width ≤ 400μs; duty cycle ≤ 2%.

Absolute Maximum Ratings

	Parameter	Max.	Units
$P_D @ T_A = 25^\circ\text{C}$	Power Dissipation ③	2.1	W
$P_D @ T_A = 70^\circ\text{C}$	Power Dissipation ③	1.3	
$P_D @ T_C = 25^\circ\text{C}$	Power Dissipation ④	57	
T_P	Peak Soldering Temperature	270	°C
T_J	Operating Junction and	-40 to + 150	
T_{STG}	Storage Temperature Range		

Thermal Resistance

	Parameter	Typ.	Max.	Units
$R_{\theta JA}$	Junction-to-Ambient ③	—	60	°C/W
$R_{\theta JA}$	Junction-to-Ambient ⑦	12.5	—	
$R_{\theta JA}$	Junction-to-Ambient ⑧	20	—	
$R_{\theta JC}$	Junction-to-Case ④,⑨	—	2.2	
$R_{\theta J-PCB}$	Junction-to-PCB Mounted	1.0	—	
	Linear Derating Factor ③	0.02		W/°C

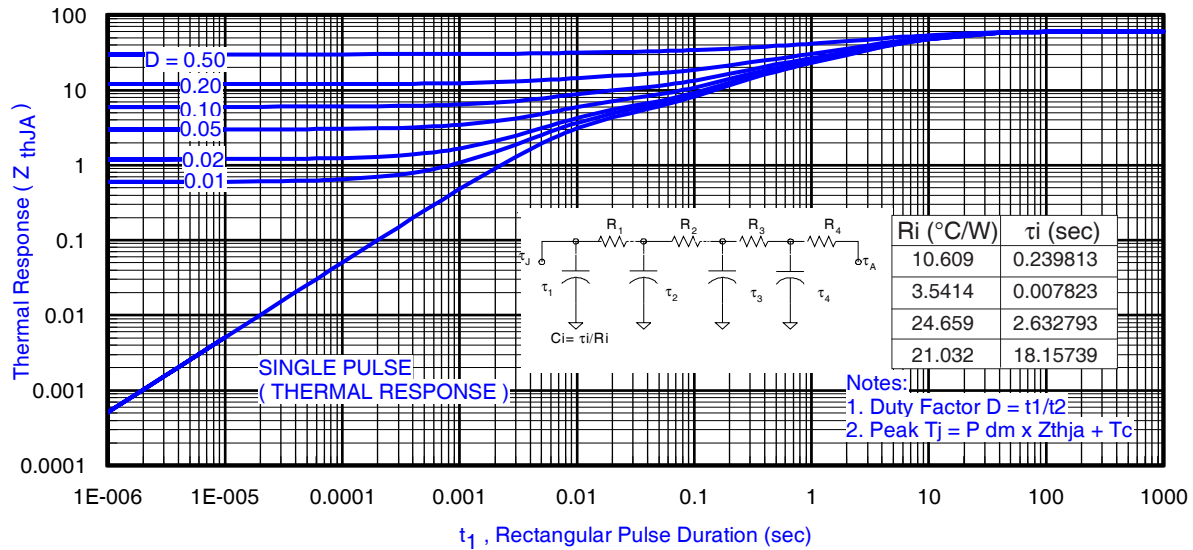
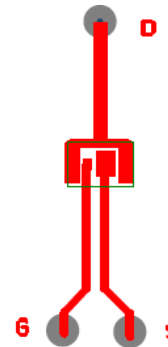
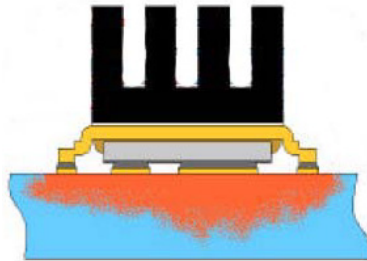
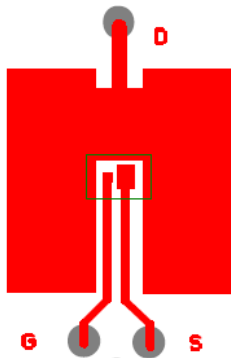

Fig 3. Maximum Effective Transient Thermal Impedance, Junction-to-Ambient ①

Notes:

- ⑦ Used double sided cooling, mounting pad with large heatsink.
- ⑧ Mounted on minimum footprint full size board with metalized back and with small clip heatsink.
- ⑨ R_{θ} is measured at T_J of approximately 90°C .



③ Surface mounted on 1 in. square Cu board (still air).

⑧ Mounted to a PCB with small clip heatsink (still air)

⑨ Mounted on minimum footprint full size board with metalized back and with small clip heatsink (still air)

IRF9395MTRPbF

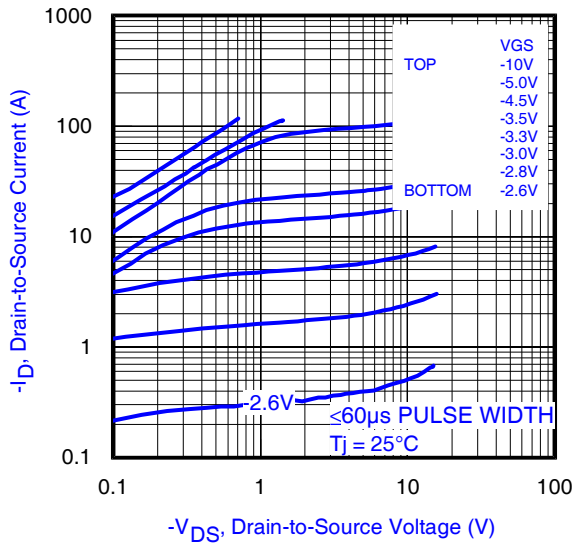

Fig 4. Typical Output Characteristics

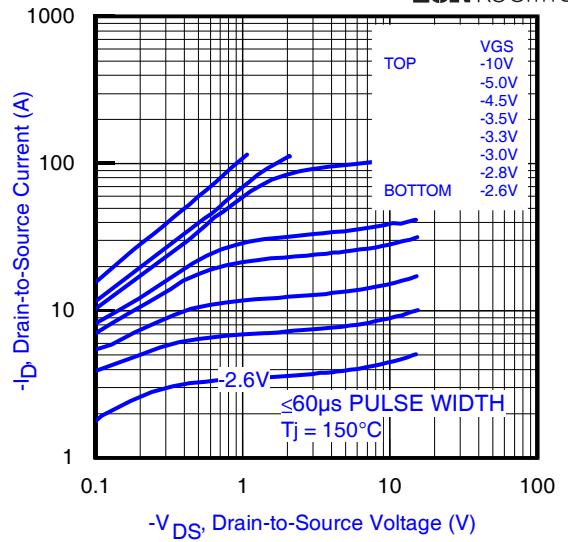

Fig 5. Typical Output Characteristics

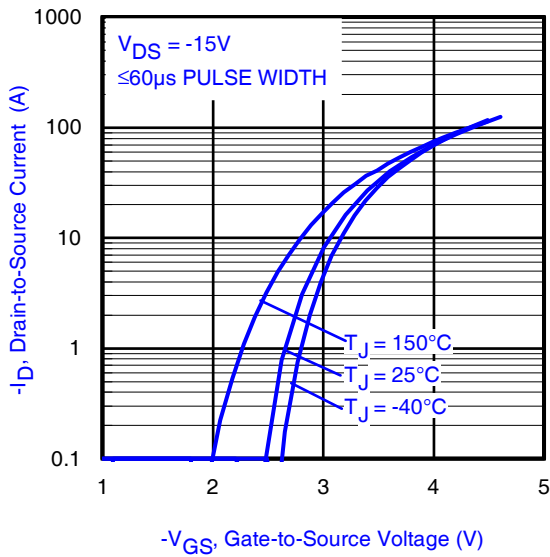

Fig 6. Typical Transfer Characteristics

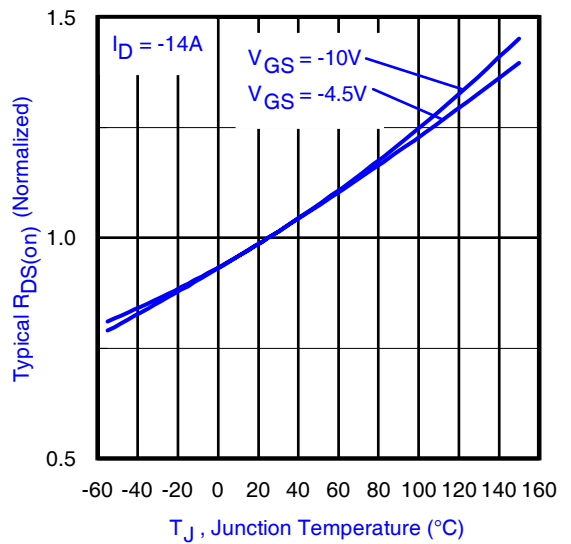

Fig 7. Normalized On-Resistance vs. Temperature

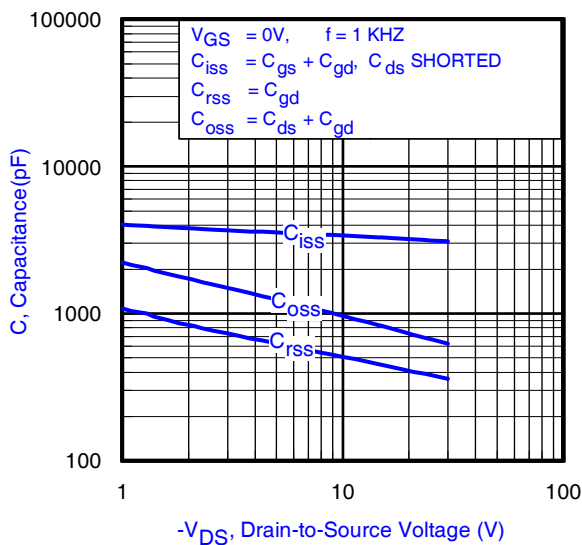

Fig 8. Typical Capacitance vs. Drain-to-Source Voltage

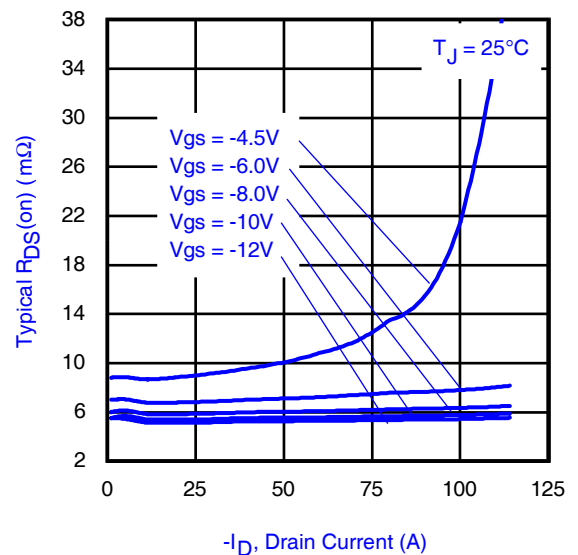

Fig 9. Typical On-Resistance vs. Drain Current and Gate Voltage

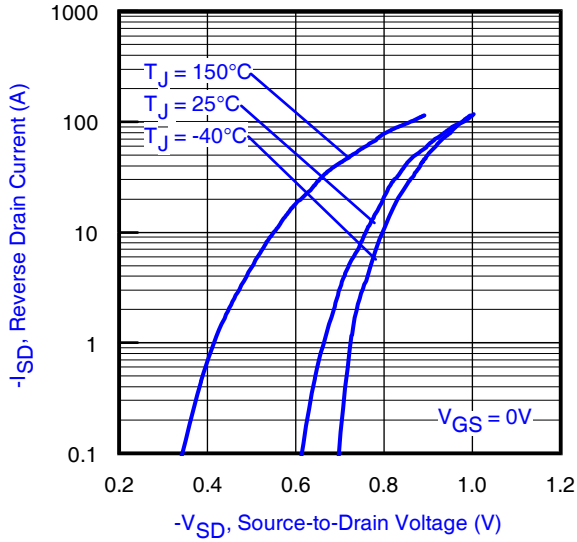

Fig 10. Typical Source-Drain Diode Forward Voltage

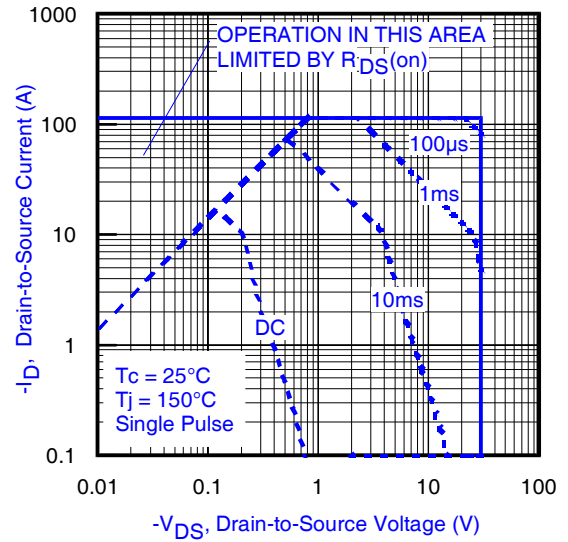

Fig 11. Maximum Safe Operating Area

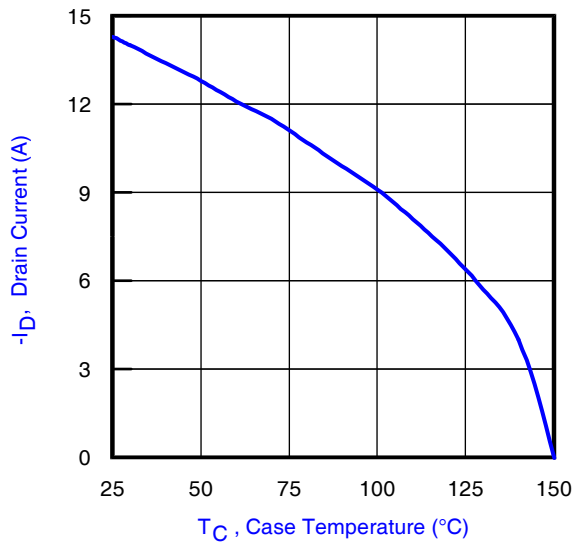

Fig 12. Maximum Drain Current vs. Case Temperature

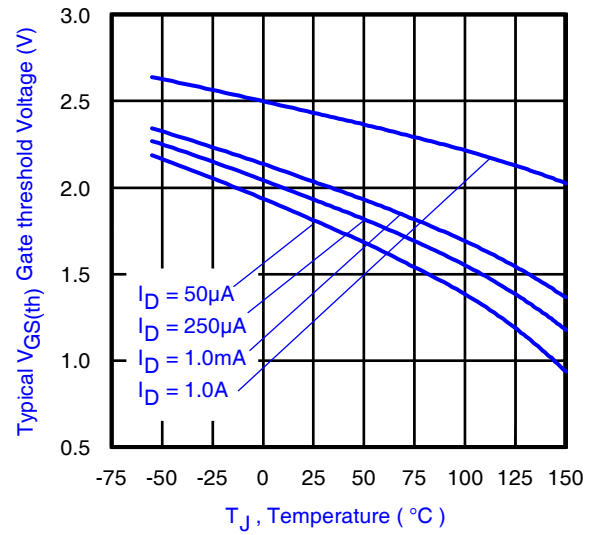

Fig 13. Typical Threshold Voltage vs. Junction Temperature

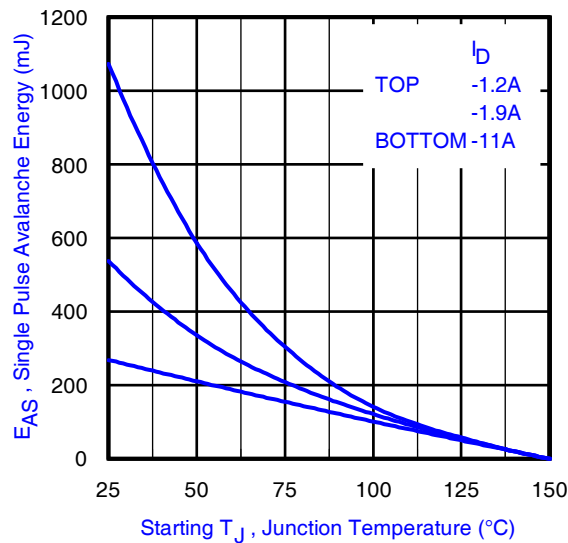

Fig 14. Maximum Avalanche Energy vs. Drain Current

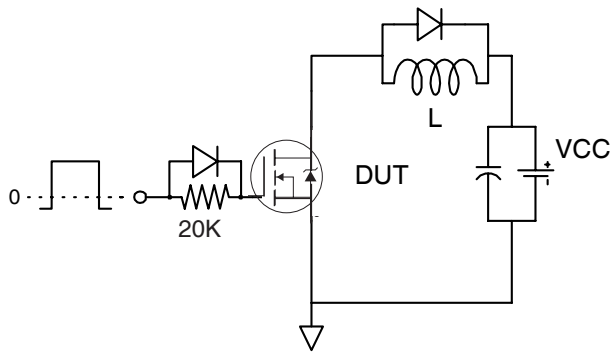

Fig 15a. Gate Charge Test Circuit

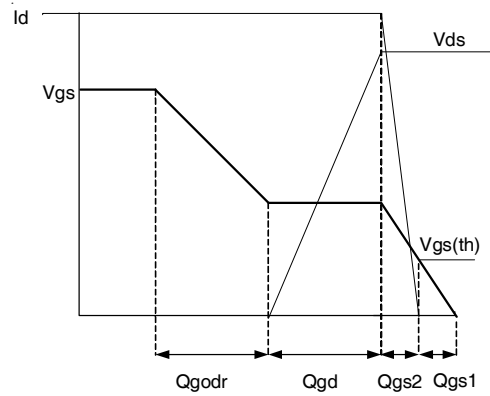

Fig 15b. Gate Charge Waveform

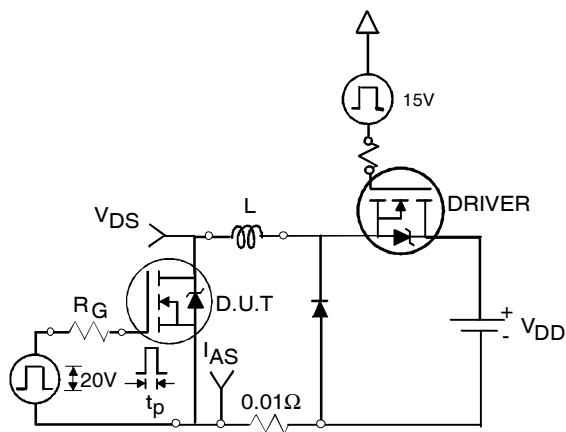

Fig 16a. Unclamped Inductive Test Circuit

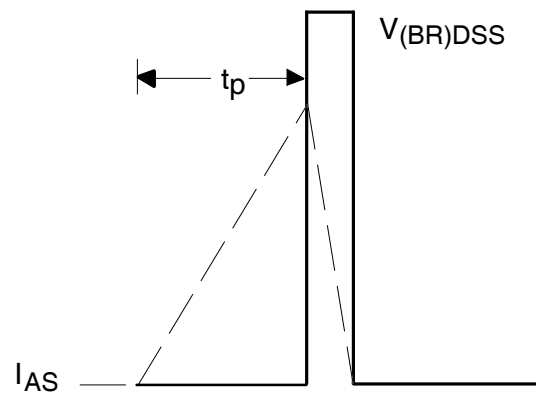

Fig 16b. Unclamped Inductive Waveforms

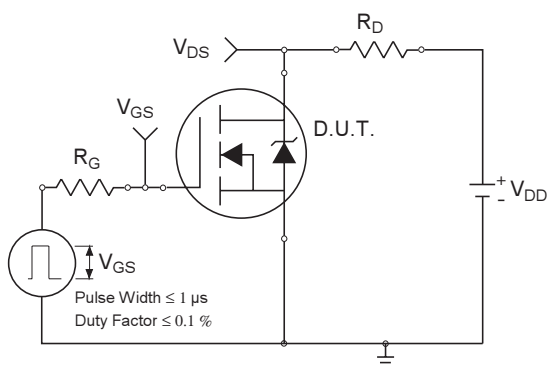

Fig 17a. Switching Time Test Circuit

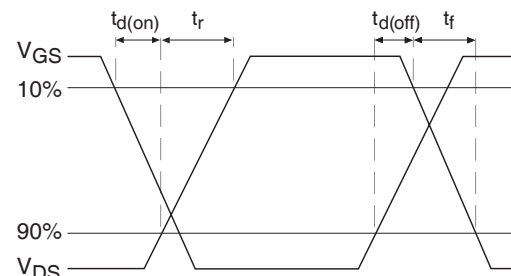

Fig 17b. Switching Time Waveforms

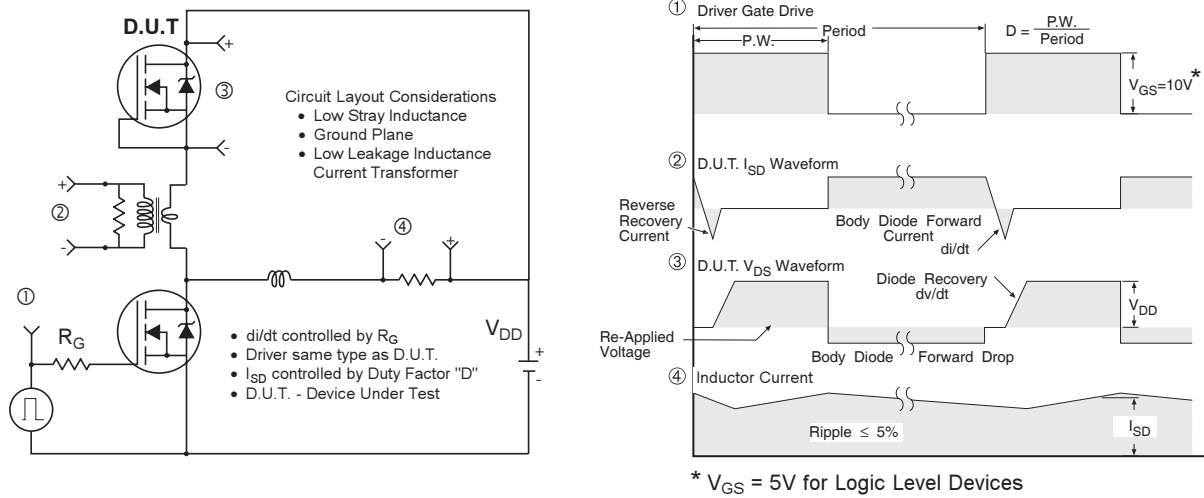
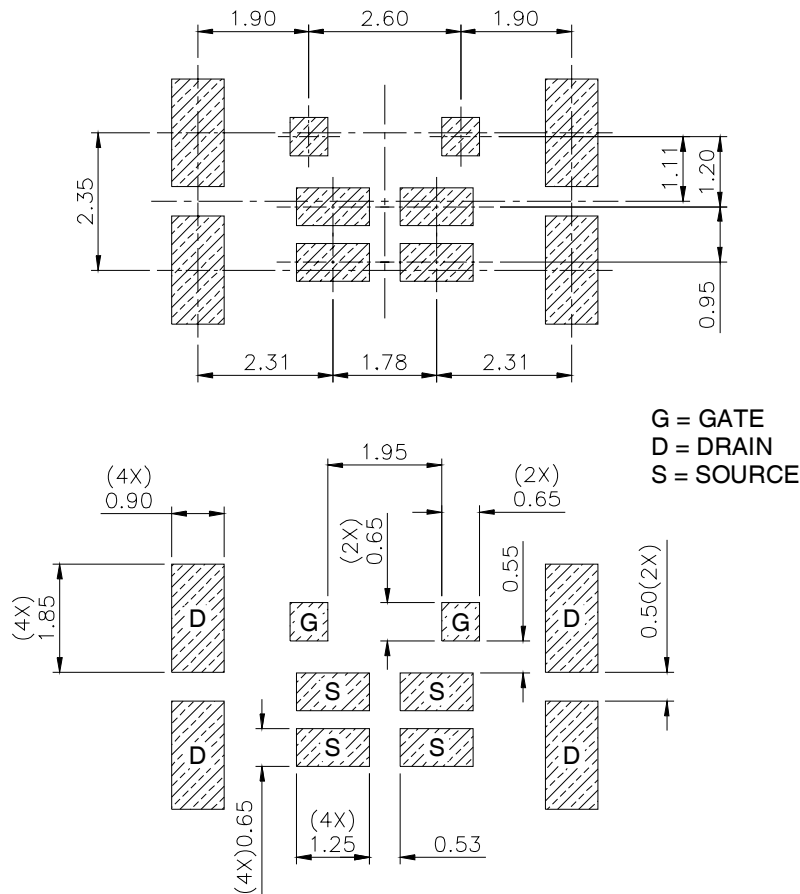

Fig 18. Diode Reverse Recovery Test Circuit for N-Channel HEXFET® Power MOSFETs

DirectFET™ Board Footprint, MC Outline (Medium Size Can, C-Designation).

Please see DirectFET application note AN-1035 for all details regarding the assembly of DirectFET. This includes all recommendations for stencil and substrate designs.



DirectFET™ Outline Dimension, MC Outline (Medium Size Can, C-Designation).

Please see DirectFET application note AN-1035 for all details regarding the assembly of DirectFET. This includes all recommendations for stencil and substrate designs.

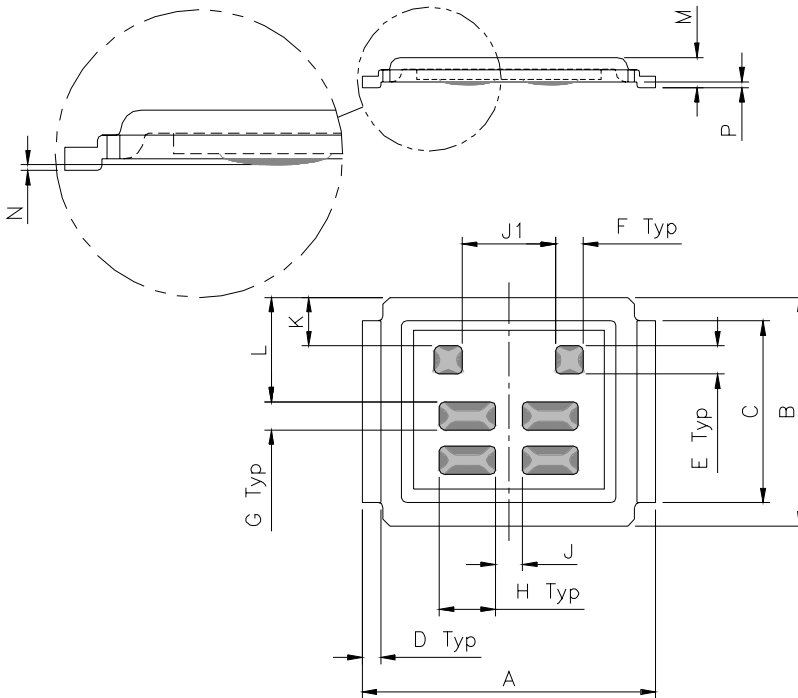

CODE	METRIC		IMPERIAL	
	MIN	MAX	MIN	MAX
A	6.25	6.35	0.246	0.250
B	4.80	5.05	0.189	0.201
C	3.85	3.95	0.152	0.156
D	0.35	0.45	0.014	0.018
E	0.58	0.62	0.023	0.024
F	0.58	0.62	0.023	0.024
G	0.58	0.62	0.023	0.024
H	1.18	1.22	0.047	0.048
J	0.56	0.60	0.022	0.023
J1	1.98	2.02	0.078	0.079
K	1.02	1.06	0.040	0.041
L	2.22	2.26	0.088	0.089
M	0.59	0.70	0.023	0.028
N	0.03	0.08	0.001	0.003
P	0.08	0.17	0.003	0.007

DirectFET™ Part Marking

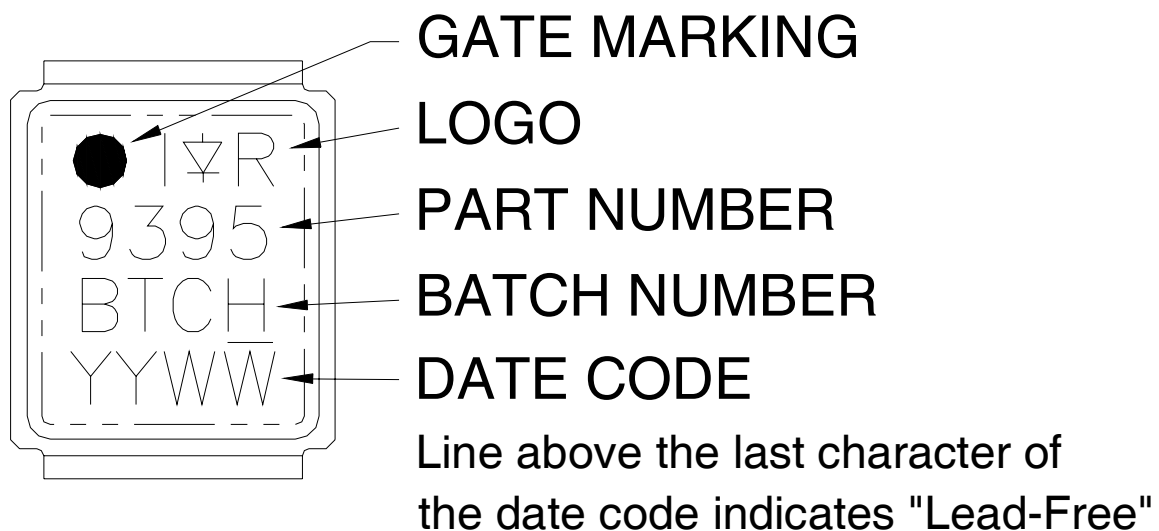

DirectFET™ Tape & Reel Dimension (Showing component orientation).

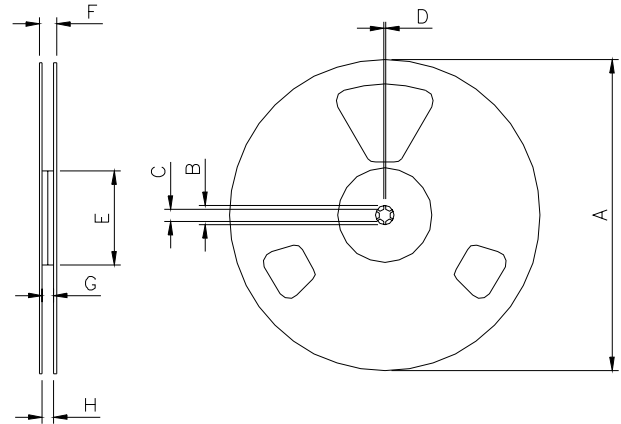
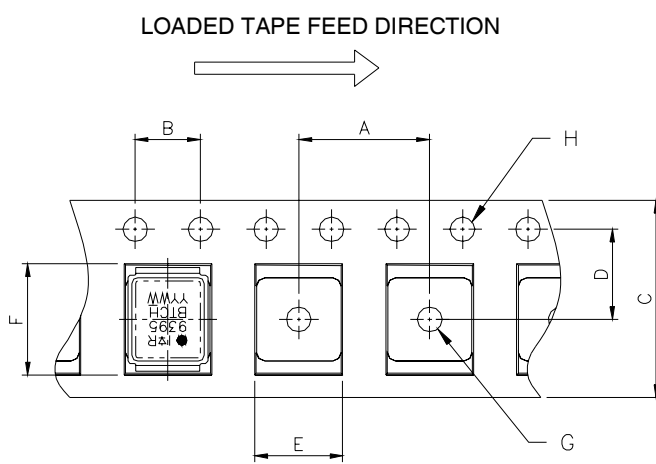

NOTE: Controlling dimensions in mm
 Std reel quantity is 4800 parts. (ordered as IRF9395MTRPbF). For 1000 parts on 7" reel, order IRF9395MTR1PbF

NOTE: CONTROLLING DIMENSIONS IN MM

CODE	DIMENSIONS			
	METRIC		IMPERIAL	
	MIN	MAX	MIN	MAX
A	7.90	8.10	0.311	0.319
B	3.90	4.10	0.154	0.161
C	11.90	12.30	0.469	0.484
D	5.45	5.55	0.215	0.219
E	5.10	5.30	0.201	0.209
F	6.50	6.70	0.256	0.264
G	1.50	N.C	0.059	N.C
H	1.50	1.60	0.059	0.063

CODE	REEL DIMENSIONS							
	STANDARD OPTION (QTY 4800)				TR1 OPTION (QTY 1000)			
	METRIC		IMPERIAL		METRIC		IMPERIAL	
	MIN	MAX	MIN	MAX	MIN	MAX	MIN	MAX
A	330.0	N.C	12.992	N.C	177.77	N.C	6.9	N.C
B	20.2	N.C	0.795	N.C	19.06	N.C	0.75	N.C
C	12.8	13.2	0.504	0.520	13.5	12.8	0.53	0.50
D	1.5	N.C	0.059	N.C	1.5	N.C	0.059	N.C
E	100.0	N.C	3.937	N.C	58.72	N.C	2.31	N.C
F	N.C	18.4	N.C	0.724	N.C	13.50	N.C	0.53
G	12.4	14.4	0.488	0.567	11.9	12.01	0.47	N.C
H	11.9	15.4	0.469	0.606	11.9	12.01	0.47	N.C

Qualification Information†

Qualification level	Consumer ^{††}	
	(per JEDEC JESD47F ^{†††} guidelines)	
Moisture Sensitivity Level	DirectFET	MSL3 (per JEDEC J-STD-020D ^{†††})
RoHS Compliant	Yes	

† Qualification standards can be found at International Rectifier's web site

<http://www.irf.com/product-info/reliability>

†† Higher qualification ratings may be available should the user have such requirements.

Please contact your International Rectifier sales representative for further information:

<http://www.irf.com/whoto-call/salesrep/>

††† Applicable version of JEDEC standard at the time of product release.

Note: For the most current drawing please refer to IR website at <http://www.irf.com/package/>

Data and specifications subject to change without notice.