



# MIC33163/4

## 4MHz, 1A, Buck Regulator with Integrated Inductor and HyperLight Load®

### General Description

The MIC33163/4 is a highly-efficient synchronous buck regulator with integrated inductor which provides the optimal trade-off between footprint and efficiency. The MIC33163/4 operates at 4MHz switching frequency and provides up to 1A output current. In addition, the 100% duty cycle and HyperLight Load® (HLL) mode-of-operation delivers very-high efficiency at light loads and ultra-fast transient response which makes the MIC33163/4 perfectly suited for any space constrained application and great alternative for low dropout regulators. An additional benefit of this proprietary architecture is very low output voltage throughout the entire load range with the use of small output capacitors.

The MIC33163/4 provides a small compact total solution size of 4.6mm x 7mm with very few tiny external components.

At higher loads, the MIC33163/4 provides a constant switching frequency around 4MHz while achieving peak efficiencies up to 93%. It also includes under-voltage lockout to ensure proper operation under power-sag conditions, internal soft-start to reduce inrush current, fold-back current limit, power good (PG) indicator and thermal shutdown. The MIC33163/4 is available in 20-pin 2.5mm x 3.0mm x 1.1mm QFN package with an operating junction temperature range from -40°C to +125°C.

Datasheets and support documentation are available on Micrel's website at: [www.micrel.com](http://www.micrel.com).

### Features

- Integrated MOSFETs and inductor
- **100% duty cycle**
- 4MHz PWM operation in continuous mode
- 1A output current
- Low output voltage ripple
- 85% typical efficiency at 1mA, up to 93% peak efficiency
- Ultra-fast transient response
- Advanced copper lead frame design provides superior thermal performance
- Low-radiated emission (EMI) per EN55022, class B
- Adjustable output voltage 0.7V to 5V
- Thermal-shutdown and current-limit protection
- Configurable soft-start with pre-bias start-up capability
- Auto discharge of 180Ω (MIC33164 only)
- Low profile 2.5mm x 3.0mm x 1.1mm QFN packages
- 0.1μA shutdown current
- 33μA quiescent current

### Applications

- 5V point-of-load (POL)
- Low-voltage distributed power systems
- Space-constrained applications
- Portable devices
- SSD storage systems
- Digital cameras

### Typical Application

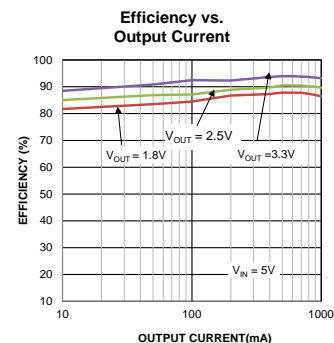
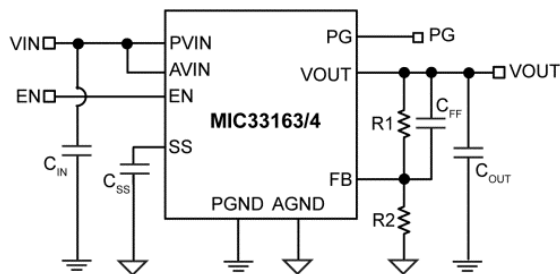

HyperLight Load is a registered trademark of Micrel, Inc.

Micrel Inc. • 2180 Fortune Drive • San Jose, CA 95131 • USA • tel +1 (408) 944-0800 • fax + 1 (408) 474-1000 • <http://www.micrel.com>

## Ordering Information

Part Number	Output Voltage	Auto Discharge	Junction Temperature Range	Package <sup>(1,2)</sup>
MIC33163YGJ	ADJ	No	-40°C to +125°C	20-Pin 2.5mm × 3mm QFN
MIC33164YGJ	ADJ	Yes	-40°C to +125°C	20-Pin 2.5mm × 3mm QFN

### Note:

1. QFN is a GREEN, RoHS-compliant package. Mold compound is Halogen Free.
2. Pb-Free Lead finish is Matte Tin.

## Pin Configuration

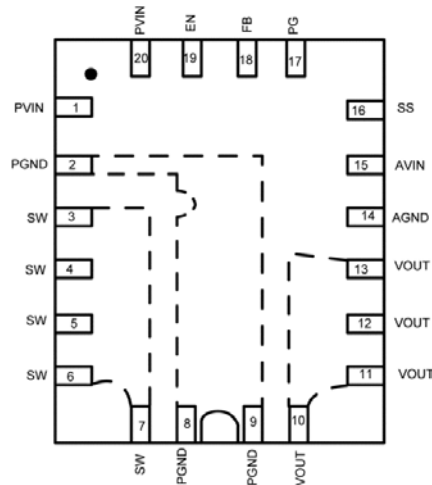

**2.5mm × 3mm QFN (GJ)  
Adjustable Output Voltage  
(Top View)**

## Pin Description

Pin Number	Pin Name	Pin Function
1, 20	PVIN	Power Input Voltage: Connect a capacitor to PGND to decouple the noise.
2, 8, 9	PGND	Power Ground.
3, 4, 5, 6, 7	SW	Switch (Output): Internal power MOSFET output switches. Disable pull-down 180Ω (MIC33164 only).
10,11,12,13	VOUT	Inductor Output. Connect a capacitor to PGND to filter the switcher output voltage
14	AGND	Analog Ground: Connect to central ground point where all high current paths meet (CIN, COUT, PGND) for best operation.
15	AVIN	Analog Input Voltage: Connect a capacitor to ground to decouple the noise.
16	SS	Soft-Start: Place a capacitor from SS pin to ground to program the soft start time.
17	PG	Power Good: Open Drain output for the power good indicator. Place a resistor between this pin and a voltage source to detect a power good condition.
18	FB	Feedback: Connect a resistor divider from VOUT to AGND to set the output voltage.
19	EN	Enable (Input): Logic high enables operation of the regulator. Logic low will shut down the device. Do not leave floating.

**Absolute Maximum Ratings<sup>(3)</sup>**

Supply Voltage ( $V_{IN} = V_{AVIN} = V_{PVIN}$ )	-0.3V to 6V
Power Good Voltage ( $V_{PG}$ )	-0.3V to 6V
Output Switch Voltage ( $V_{SW}$ )	-0.3V to 6V
Enable Input Voltage ( $V_{EN}$ )	-0.3V to $V_{IN}$
Junction Temperature ( $T_J$ )	+150°C
Storage Temperature Range ( $T_S$ )	-65°C to +150°C
Lead Temperature (soldering, 10s)	260°C
ESD Rating <sup>(5)</sup>	ESD Sensitive

**Operating Ratings<sup>(4)</sup>**

Supply Voltage ( $V_{IN} = V_{AVIN} = V_{PVIN}$ )	2.7V to 5.5V
Enable Input Voltage ( $V_{EN}$ )	0V to $V_{IN}$
Feedback Voltage ( $V_{FB}$ )	0.7V to $V_{IN}$
Junction Temperature Range ( $T_J$ )	-40°C ≤ $T_J$ ≤ +125°C
Thermal Resistance	
20-Pin 2.5mm × 3mm QFN ( $\theta_{JA}$ )	50°C/W

**Electrical Characteristics<sup>(6)</sup>**

$T_A = 25^\circ\text{C}$ ,  $V_{IN} = V_{EN} = 3.6\text{V}$ ;  $C_{OUT} = 22\mu\text{F}$  unless otherwise specified. **Bold** values indicate  $-40^\circ\text{C} \leq T_J \leq +125^\circ\text{C}$ , unless otherwise noted.

Parameter	Condition	Min.	Typ.	Max.	Units
Supply Voltage Range		<b>2.7</b>		<b>5.5</b>	V
Undervoltage Lockout Threshold	(Turn-On)	<b>2.40</b>	2.53	<b>2.65</b>	V
Undervoltage Lockout Hysteresis			75		mV
Quiescent Current	$I_{OUT} = 0\text{mA}$ , $V_{SNS} > 1.2 \times V_{OUT}$ Nominal		33	<b>55</b>	$\mu\text{A}$
Shutdown Current	$V_{EN} = 0\text{V}$ ; $V_{IN} = 5.5\text{V}$		0.1	<b>2</b>	$\mu\text{A}$
Output Voltage Accuracy	$V_{IN} = 3.6\text{V}$ if $V_{OUTNOM} < 2.5\text{V}$ , $I_{LOAD} = 20\text{mA}$	<b>-2.5</b>		<b>+2.5</b>	%
	$V_{IN} = 5.5\text{V}$ if $V_{OUTNOM} \geq 2.5\text{V}$ , $I_{LOAD} = 20\text{mA}$				
Feedback Regulation Voltage		<b>0.682</b>	0.7	<b>0.717</b>	V
Current Limit	$V_{SNS} = 0.9 \times V_{OUTNOM}$	<b>2.5</b>	3.3		A
Output Voltage Line Regulation	$V_{IN} = 3.6\text{V}$ to $5.5\text{V}$ , $I_{LOAD} = 20\text{mA}$		0.3		%/V
Output Voltage Load Regulation	$20\text{mA} \leq I_{LOAD} \leq 1\text{A}$ , $V_{IN} = 3.6\text{V}$		0.3		%
	$20\text{mA} \leq I_{LOAD} \leq 1\text{A}$ , $V_{IN} = 5.5\text{V}$		0.3		
PWM Switch ON-Resistance	$I_{SW} = 100\text{mA}$ PMOS		0.13		$\Omega$
	$I_{SW} = -100\text{mA}$ NMOS		0.13		$\Omega$
Switching Frequency	$I_{OUT} = 120\text{mA}$		4		MHz
Soft-Start Time	$V_{OUT} = 90\%$ , $C_{SS} = 1\text{nF}$		1000		$\mu\text{s}$
Soft-Start Current	$V_{SS} = 0\text{V}$		2.2		$\mu\text{A}$
Power Good Threshold (Rising)	% of $V_{NOM}$	85	90	95	%

**Notes:**

- Exceeding the absolute maximum ratings may damage the device.
- The device is not guaranteed to function outside its operating ratings.
- Devices are ESD sensitive. Handling precautions are recommended. Human body model, 1.5k $\Omega$  in series with 100pF.
- Specification for packaged product only.

## Electrical Characteristics<sup>(6)</sup> (Continued)

$T_A = 25^\circ\text{C}$ ;  $V_{IN} = V_{EN} = 3.6\text{V}$ ;  $C_{OUT} = 22\mu\text{F}$  unless otherwise specified. **Bold** values indicate  $-40^\circ\text{C} \leq T_J \leq +125^\circ\text{C}$ , unless otherwise noted.

Parameter	Condition	Min.	Typ.	Max.	Units
Power Good Threshold Hysteresis			7		%
Power Good Pull-Down	$V_{SNS} = 90\% V_{NOMINAL}$ , $I_{PG} = 1\text{mA}$		60	200	mV
Enable Threshold	Turn-On	<b>0.5</b>	0.8	<b>1.2</b>	V
Enable Hysteresis			70		mV
Enable Input Current			0.1	<b>2</b>	$\mu\text{A}$
Overtemperature Shutdown			160		$^\circ\text{C}$
Overtemperature Shutdown Hysteresis			20		$^\circ\text{C}$
SW Pull-Down Resistance (MIC33164 only)	$V_{EN} = 0\text{V}$		180		$\Omega$

# Typical Characteristics

**Efficiency vs. Output Current**

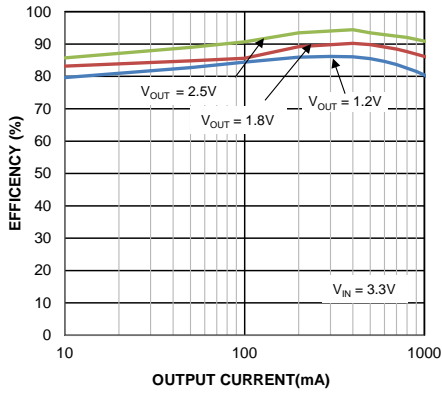

**Efficiency vs. Output Current**

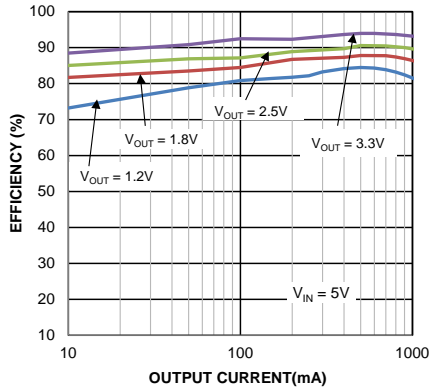

**VOUT Rise Time vs. CSS**

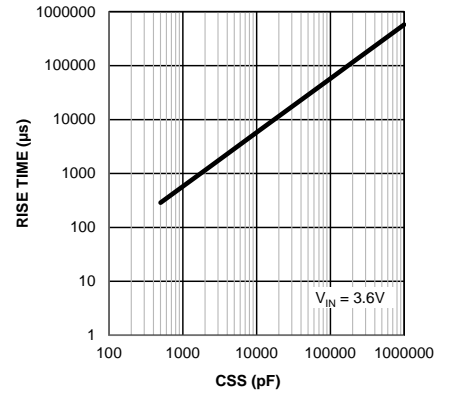

**Current Limit vs. Input Voltage**

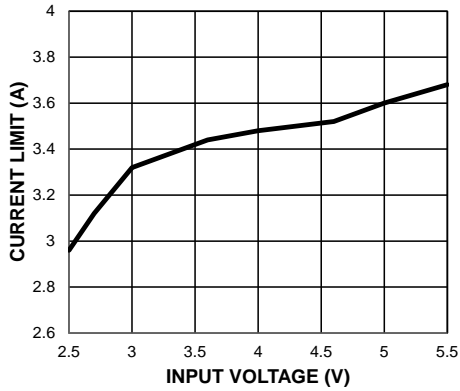

**Quiscent Current vs. Input Voltage**

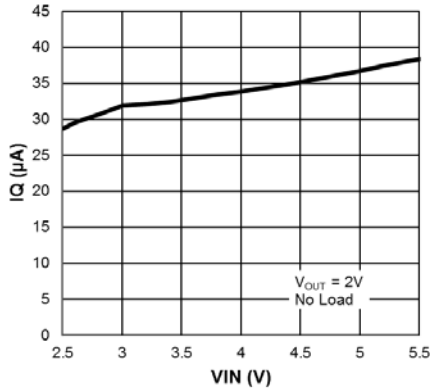

**Quiscent Current vs. Temperature**

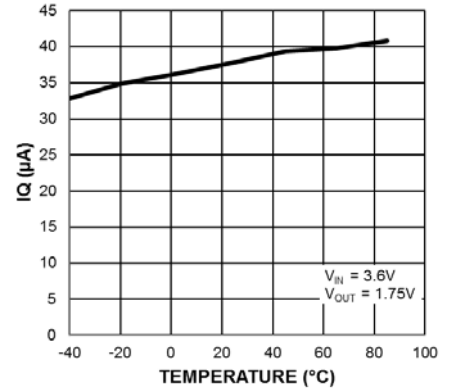

**Line Regulation (light loads)**

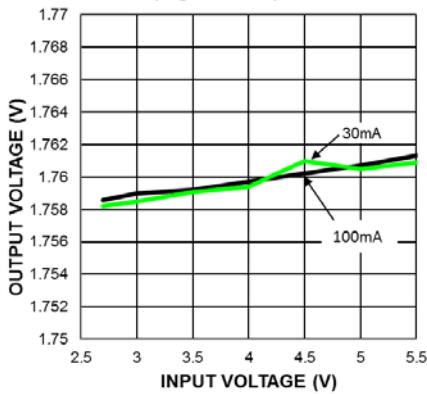

**Line Regulation (High Loads)**

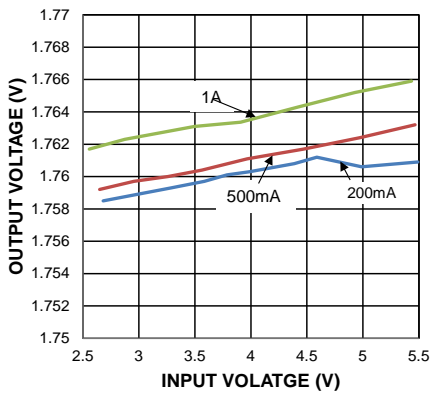

**Max. Output Current vs. Temperature**

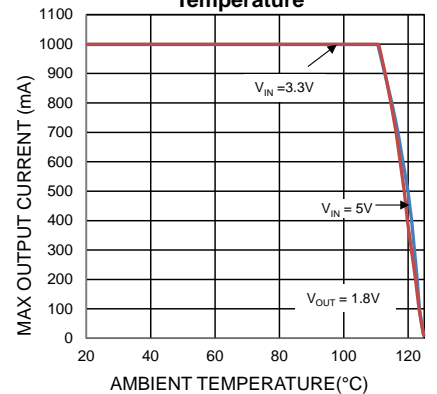

## Typical Characteristics (Continued)

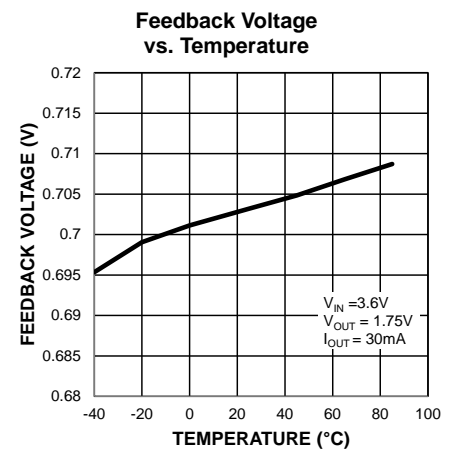
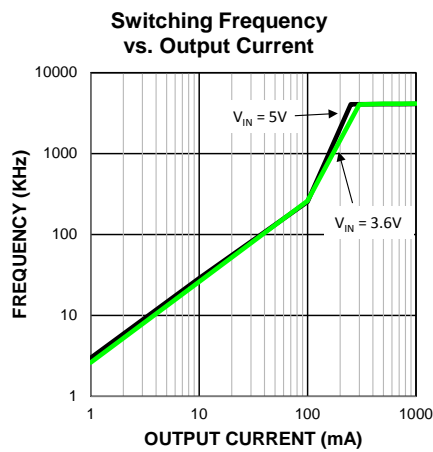
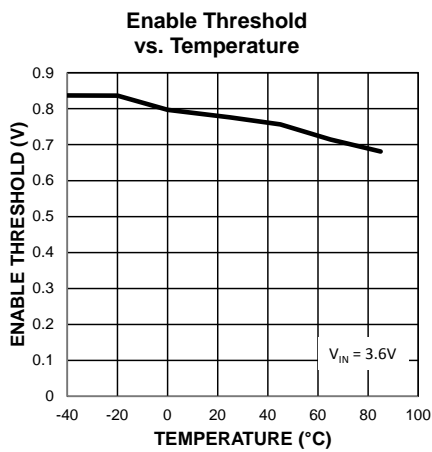
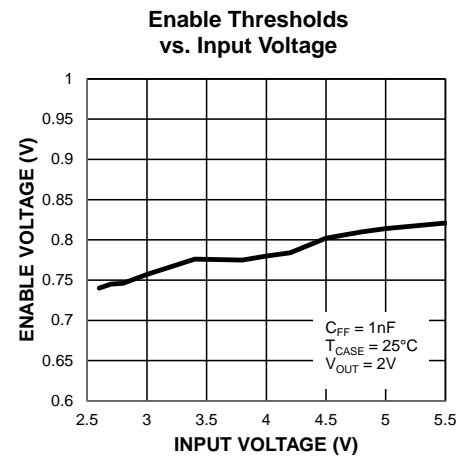
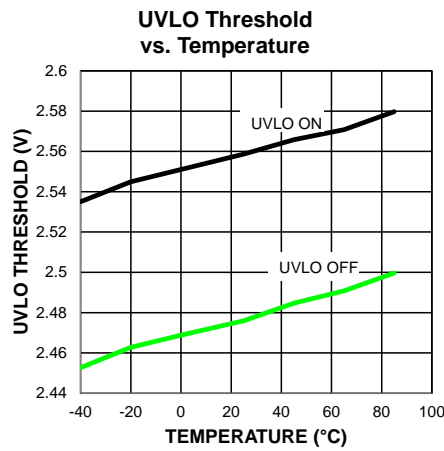
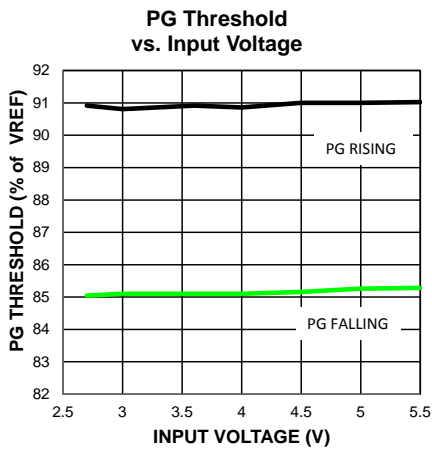
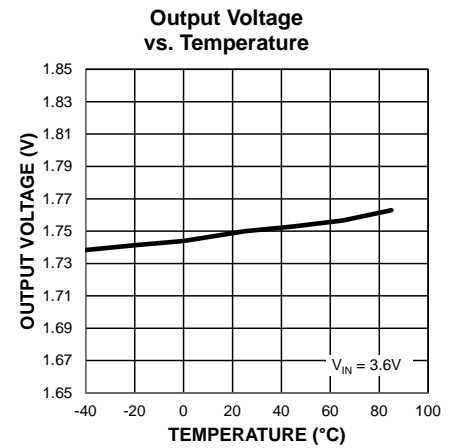
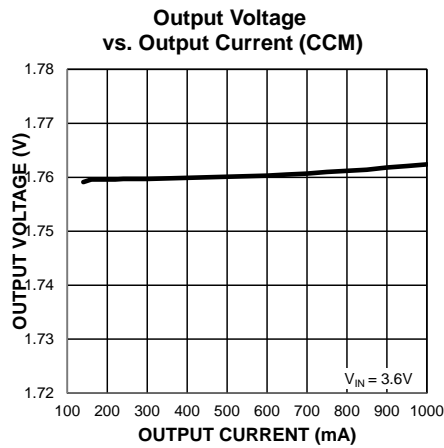
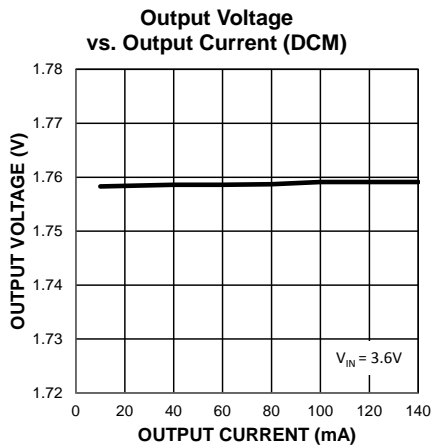

### Typical Characteristics (Continued)

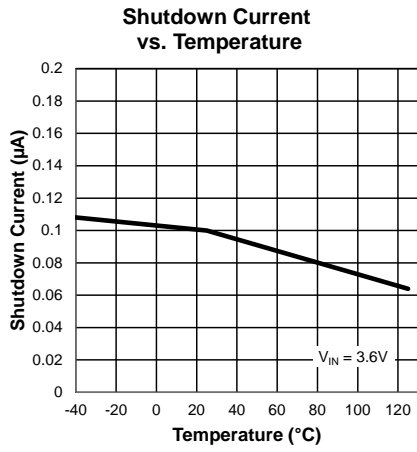

## Functional Characteristics

**Switching Waveform  
Discontinuous Mode (1mA)**

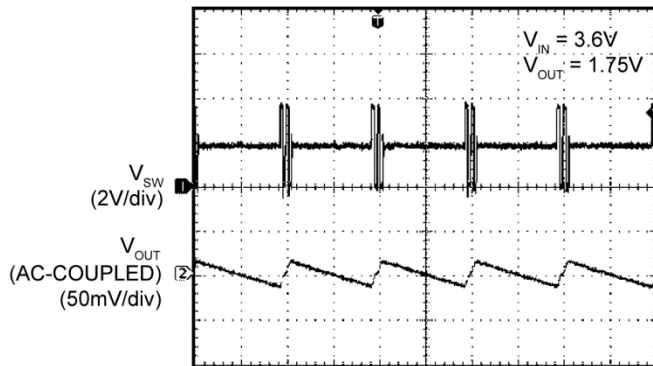

Time (4.0µs/div)

**Switching Waveform  
Discontinuous Mode (10mA)**

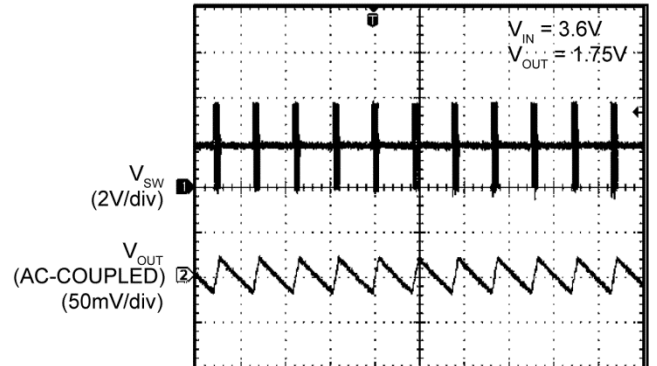

Time (10µs/div)

**Switching Waveform  
Continuous Mode (200mA)**

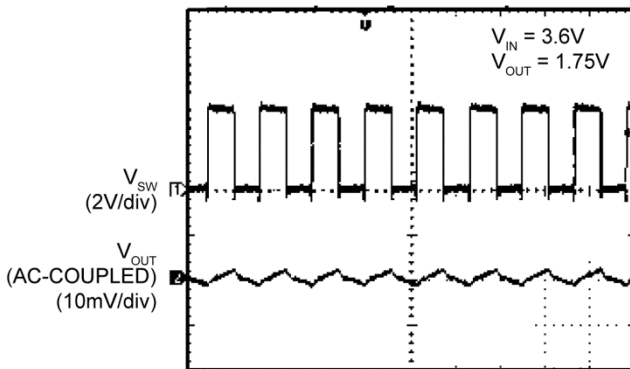

Time (200ns/div)

**Switching Waveform  
Continuous Mode (500mA)**

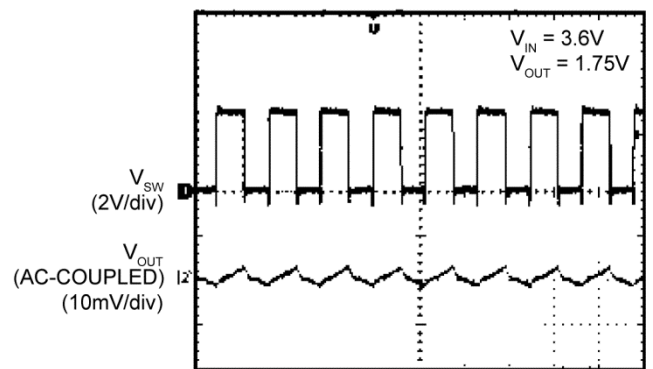

Time (200ns/div)

**Switching Waveform  
Continuous Mode (750mA)**

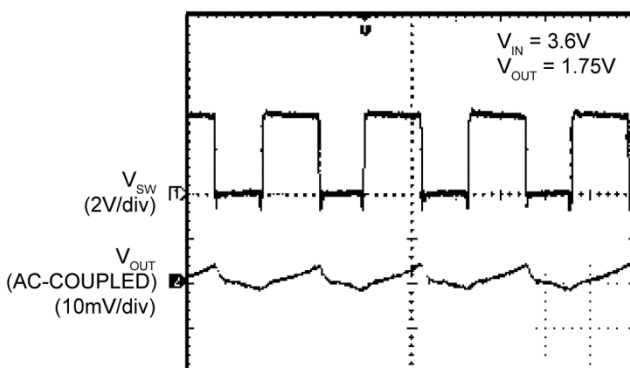

Time (100ns/div)

**Switching Waveform  
Continuous Mode (1A)**

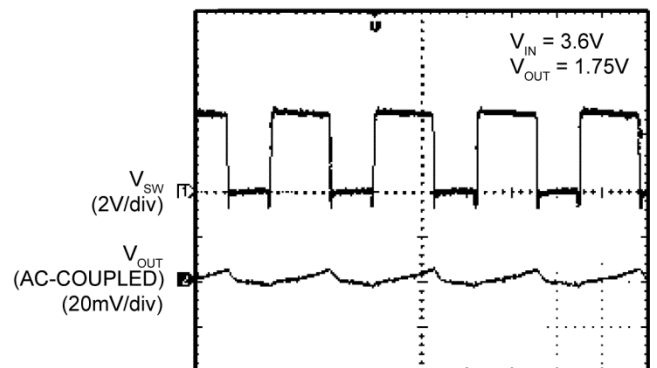

Time (100ns/div)



### Functional Characteristics (Continued)

**Load Transient (0mA – 200mA)**

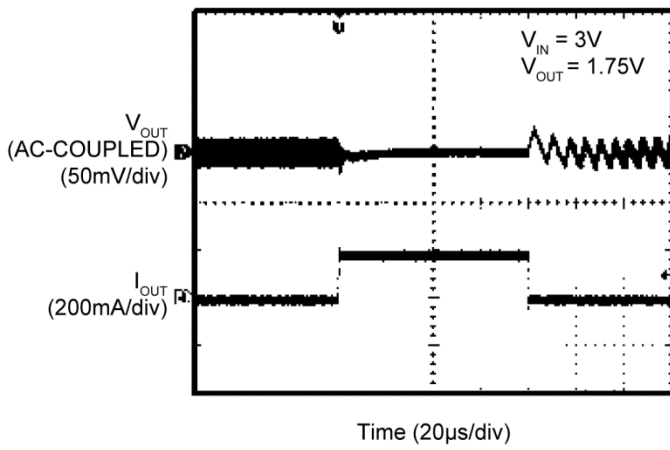

**Load Transient (10mA – 750mA)**

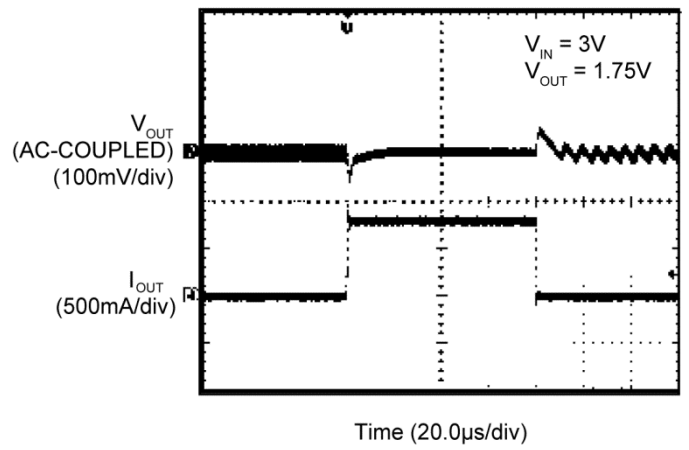

**Load Transient (200 – 600mA)**

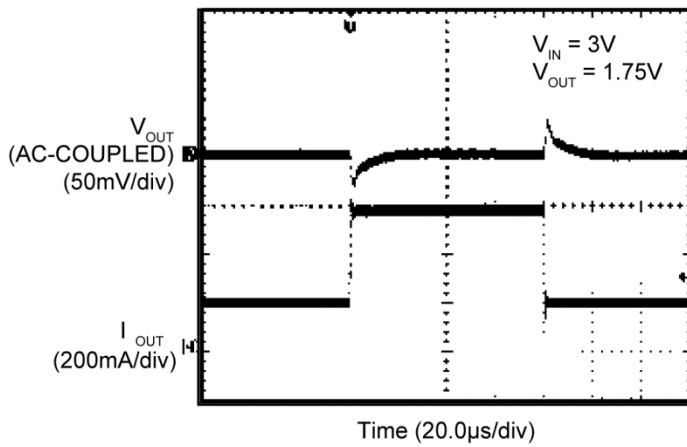

**Load Transient (200mA – 800mA)**

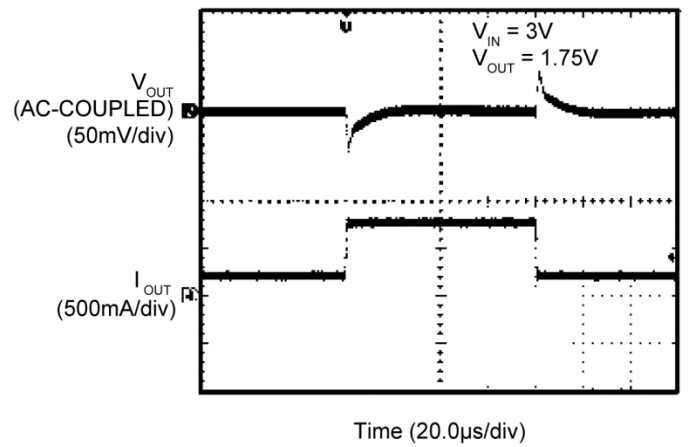

**Load Transient (250mA – 1A)**

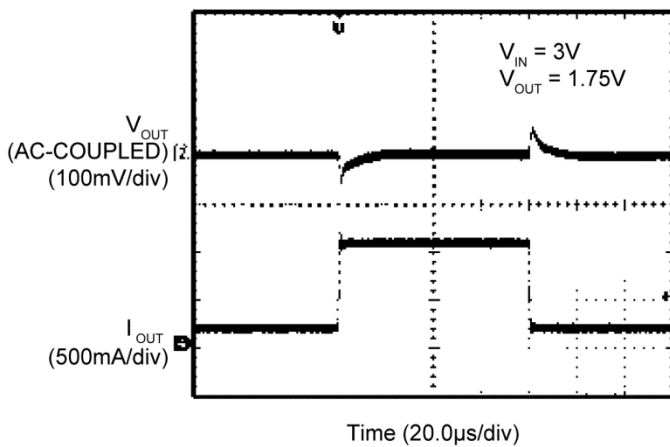

### Functional Characteristics (Continued)

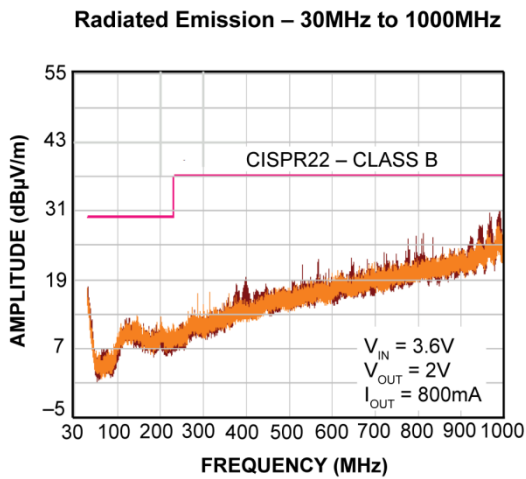
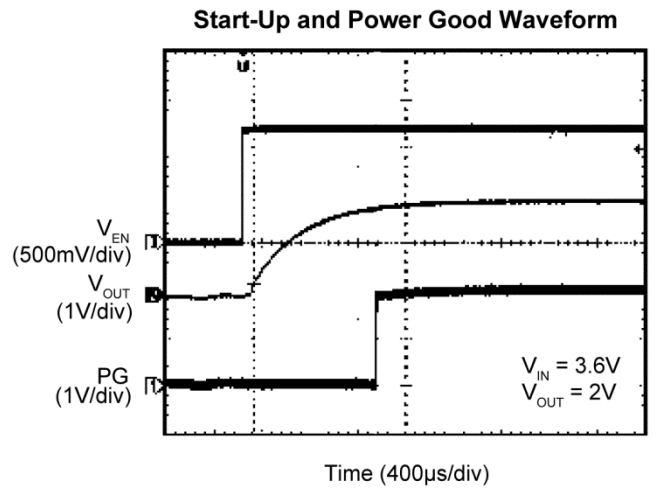
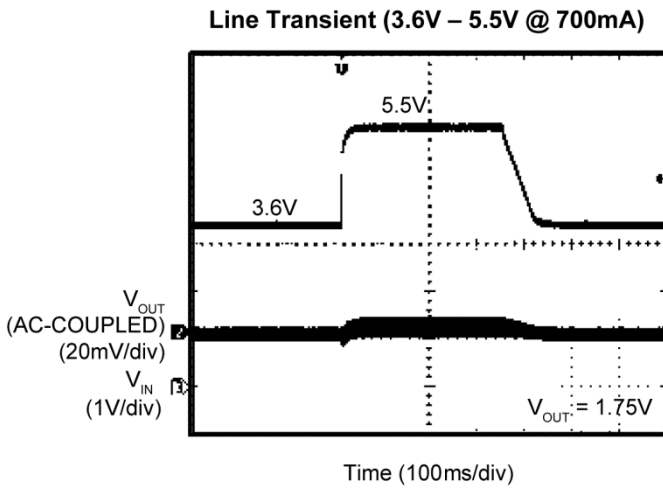
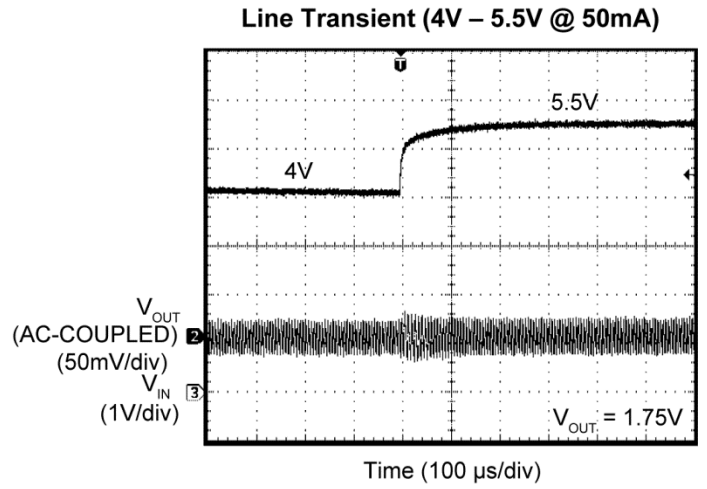
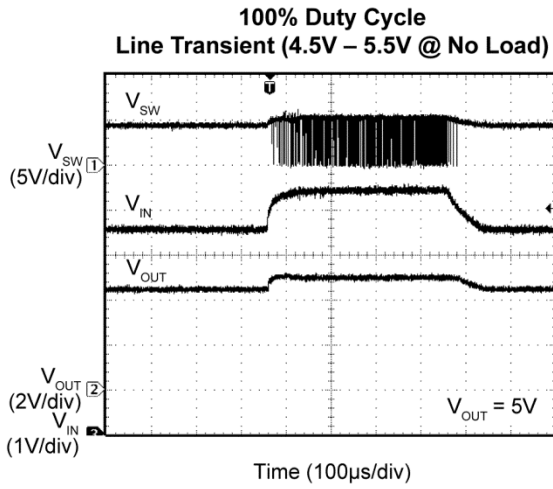

## Functional Diagram

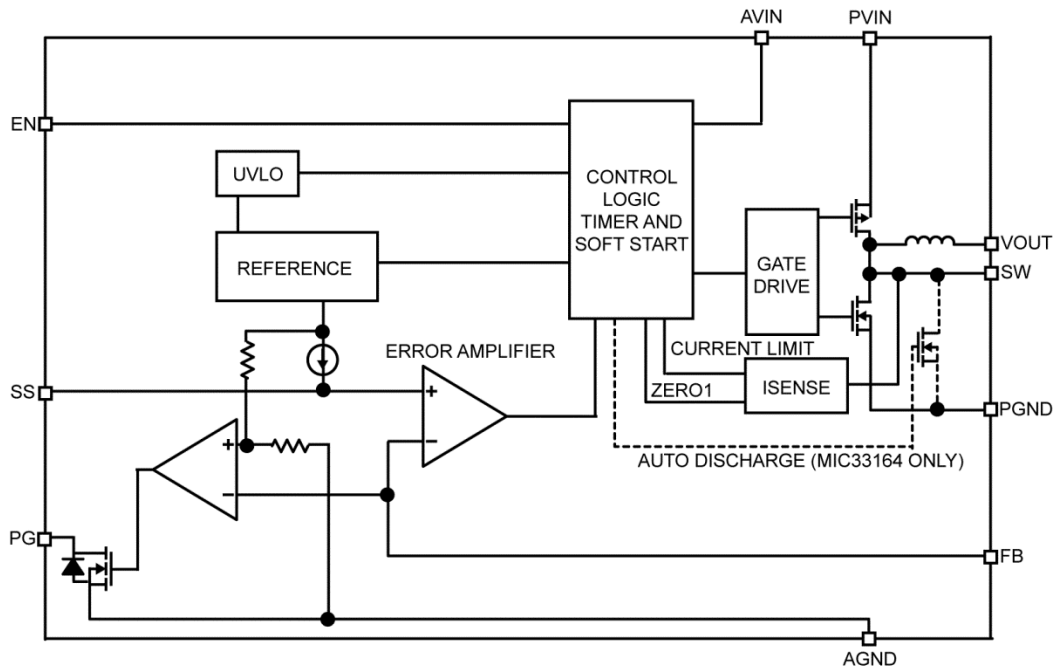

Figure 1. Simplified MIC33163/4 Functional Block Diagram – Adjustable Output Voltage

## Functional Description

### PVIN

The input supply (PV<sub>IN</sub>) provides power to the internal MOSFETs for the switch-mode regulator. The PV<sub>IN</sub> operating input voltage range of 2.7V to 5.5V so an input capacitor, with a minimum voltage rating of 6.3V, is recommended. Due to the high switching speed, a minimum 2.2μF bypass capacitor placed close to PV<sub>IN</sub> and the power ground (PGND) pin is required. Refer to the PCB Layout Recommendations section for details.

### AVIN

Analog VIN (AV<sub>IN</sub>) provides power to the internal control and analog supply circuitry. AVIN must be tied to PVIN. Careful layout should be considered to ensure that any high-frequency switching noise caused by PVIN is reduced before reaching AVIN. A 1μF capacitor as close as to AVIN as possible is recommended. Refer to the PCB Layout Recommendations section for details.

### EN/Shutdown

A logic high signal on the enable pin activates the output voltage of the device. A logic low signal on the enable pin deactivates the output and reduces supply current to 0.1μA. When disabled the MIC33164 switches an internal load of 180Ω on the regulators switch node to discharge the output. The MIC33163/4 features external soft-start circuitry adjusted by the soft start (SS) pin, which reduces in-rush current and prevents the output voltage from overshooting at start up. Do not leave the EN pin floating.

### SW

The switch (SW) connects to the controller end of integrated inductor. The other end of the inductor is connected to VOUT pin. Due to the high-speed switching on this pin, the switch node should be not be connected.

### VOUT

The output pin (VOUT) connects to the output of integrated inductor. The output capacitor should be connected from this pin to PGND as close to the module as possible. The MIC33163/4 is rated for an output current of up to 1A. A 22μF capacitor is recommended for best performance. Refer to the PCB Layout Recommendations section for details.

### AGND

The analog ground (AGND) is the ground path for the biasing and control circuitry. The current loop for the signal ground should be separate from the power ground (PGND) loop. Refer to the [PCB Layout Recommendations](#) section for details.

### PGND

The power ground (PGND) pin is the ground path for the high current in PWM mode. The current loop for the power ground should be as small as possible and separate from the analog ground (AGND) loop as applicable. Refer to the [PCB Layout Recommendations](#) section for details.

### PG

The power good (PG) pin is an open drain output which indicates logic high when the output voltage is typically above 90% of its steady state voltage. A pull-up resistor of more than 5kΩ should be connected from PG to V<sub>OUT</sub>.

### SS

The soft-start (SS) pin is used to control the output voltage ramp-up time. Setting C<sub>SS</sub> to 1nF sets the start-up time to the recommended minimum of approximately 575μs. The start-up time can be determined by Equation 1:

$$T_{SS} = 250 \times 10^3 \times \ln(10) \times C_{SS} \quad \text{Eq. 1}$$

The action of the soft-start capacitor is to control the rise time of the internal reference voltage between 0% and 100% of its nominal steady state value.

### FB

This is the control input for programming the output voltage. A resistor divider network is connected to this pin from the output and is compared to the internal 0.7V reference within the regulation loop.

The output voltage can be programmed between 0.7V and 5V using Equation 2:

$$V_{\text{OUT}} = V_{\text{REF}} \times \left( 1 + \frac{R1}{R2} \right) \quad \text{Eq. 2}$$

where:

R1 is the top resistor, R2 is the bottom resistor.

**Table 1. Example Feedback Resistor Values**

<b>V<sub>OUT</sub></b>	<b>R1</b>	<b>R2</b>
1.2V	215k	301k
1.5V	301k	261k
1.8V	340k	215k
2.5V	274k	107k
3.3V	383k	102k
3.6V	422k	102k
5V	634k	102k

## Application Information

The MIC33163/4 is a high-performance DC-to-DC step-down regulator offering a small solution size of 4.6mm x 7mm. Supporting an output current up to 1A inside a tiny 3mm x 2.5mm QFN package, the MIC33163/4 requires very few external components while meeting today's miniature portable electronic device needs. Using the HLL switching scheme, the MIC33163/4 is able to maintain high efficiency throughout the entire load range while providing ultra-fast load transient response. The following sections provide additional device application information.

### Input Capacitor

A 2.2μF ceramic capacitor or greater should be placed close to the VIN pin and PGND pin for bypassing. A Murata GRM188R60J475KE19D, size 0603, 4.7μF ceramic capacitor is recommended based upon performance, size and cost. A X5R or X7R temperature rating is recommended for the input capacitor. Y5V temperature rating capacitors, aside from losing most of their capacitance over temperature, can also become resistive at high frequencies. This reduces their ability to filter out high-frequency noise.

### Output Capacitor

The MIC33163/4 is designed for use with a 22μF or greater ceramic output capacitor. Increasing the output capacitance will lower output ripple and improve load transient response but could also increase solution size or cost. A low equivalent series resistance (ESR) ceramic output capacitor such as the TDK C1608X5R0J226M080AC, size 0603, 22μF ceramic capacitor is recommended based upon performance, size and cost. Both the X7R or X5R temperature rating capacitors are recommended. The Y5V and Z5U temperature rating capacitors are not recommended due to their wide variation in capacitance over temperature and increased resistance at high frequencies.

### Compensation

The MIC33163/4 is designed to be stable with a 22μF ceramic (X5R) output capacitor. An external feedback capacitor of 15pF to 68pF is required for optimum regulation performance.

### 100% Duty Cycle Low Dropout Operation

The MIC33163/4 enters 100% duty cycle when the input voltage gets close to the nominal output voltage, in this case the high-side MOSFET switch is turned on 100% for one or more cycles. By decreasing the input voltage further the high-side MOSFET switch turns on completely. In this case the small difference between VIN and VOUT is determined by RDSON and DCR of the inductor. This is extremely useful in battery-powered applications to accomplish longest operation time.

## Efficiency Considerations

Efficiency is defined as the amount of useful output power, divided by the amount of power supplied, as shown in Equation 3:

$$\text{Efficiency \%} = \left( \frac{V_{\text{OUT}} \times I_{\text{OUT}}}{V_{\text{IN}} \times I_{\text{IN}}} \right) \times 100 \quad \text{Eq. 3}$$

Maintaining high efficiency serves two purposes. It reduces power dissipation in the power supply, reducing the need for heat sinks and thermal design considerations and it reduces consumption of current for battery-powered applications. Reduced current draw from a battery increases the device's operating time and is critical in hand held devices.

There are two types of losses in switching converters; DC losses and switching losses. DC losses are simply the power dissipation of  $I^2R$ . Power is dissipated in the high side switch during the on cycle. Power loss is equal to the high side MOSFET  $R_{\text{DS(ON)}}$  multiplied by the switch current squared. During the off cycle, the low side N-channel MOSFET conducts, also dissipating power. Device operating current also reduces efficiency. The product of the quiescent (operating) current and the supply voltage represents another DC loss. The current required driving the gates on and off at a constant 4MHz frequency and the switching transitions make up the switching losses.

Figure 2 shows an efficiency curve. From no load to 100mA, efficiency losses are dominated by quiescent current losses, gate drive and transition losses. By using the HLL mode, the MIC33163/4 is able to maintain high efficiency at low output currents.

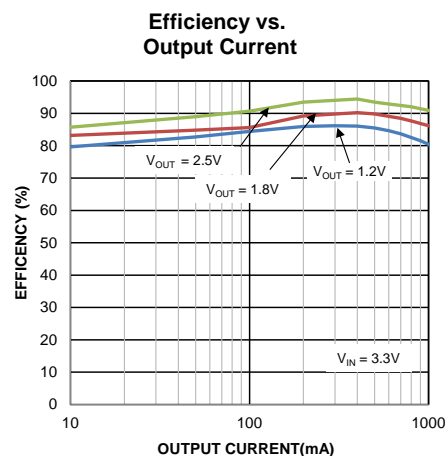

Figure 2. Efficiency under Load

Over 100mA, efficiency loss is dominated by MOSFET  $R_{DS(ON)}$  and inductor losses. Higher input supply voltages will increase the gate-to-source threshold on the internal MOSFETs, thereby reducing the internal  $R_{DS(ON)}$ . This improves efficiency by reducing DC losses in the device.

### HyperLight Load (HLL) Mode

MIC33163/4 uses a Micrel-patented minimum on- and off-time proprietary control loop (PCL) called HyperLight Load (HLL). When the output voltage falls below the regulation threshold, the error comparator begins a switching cycle that turns the PMOS on and keeps it on for the duration of the minimum-on-time. This increases the output voltage. If the output voltage is over the regulation threshold, then the error comparator turns the PMOS off for a minimum-off-time until the output drops below the threshold. The NMOS acts as an ideal rectifier that conducts when the PMOS is off. Using a NMOS switch instead of a diode allows for lower voltage drop across the switching device when it is on. The asynchronous switching combination between the PMOS and the NMOS allows the control loop to work in discontinuous mode for light load operations. In discontinuous mode, the MIC33163/4 works in pulse frequency modulation (PFM) to regulate the output. As the output current increases, the off-time decreases, thus provides more energy to the output. This switching scheme improves the efficiency of MIC33163/4 during light load currents by only switching when it is needed. As the load current increases, the MIC33163/4 goes into continuous conduction mode (CCM) and switches at a frequency centered at 4MHz.

As shown in [Figure 3](#), as the output current increases, the switching frequency also increases until the MIC33163/4 goes from HLL mode to PWM mode at approximately 120mA. The MIC33163/4 will switch at a relatively constant frequency around 4MHz once the output current is over 220mA.

### Emission Characteristic of MIC33163/4

The MIC33163/4 integrates switching components in a single package for reduced emissions compared to standard buck regulators with external MOSFETs and inductors. The radiated EMI scans for the MIC33163/4 are shown in the Functional Characteristic.

The limit on the graph is per EN55022 class B standard.

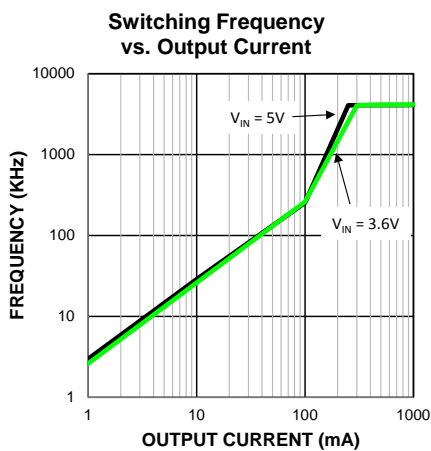

**Figure 3. SW Frequency vs. Output Current**

## Typical Application Circuit

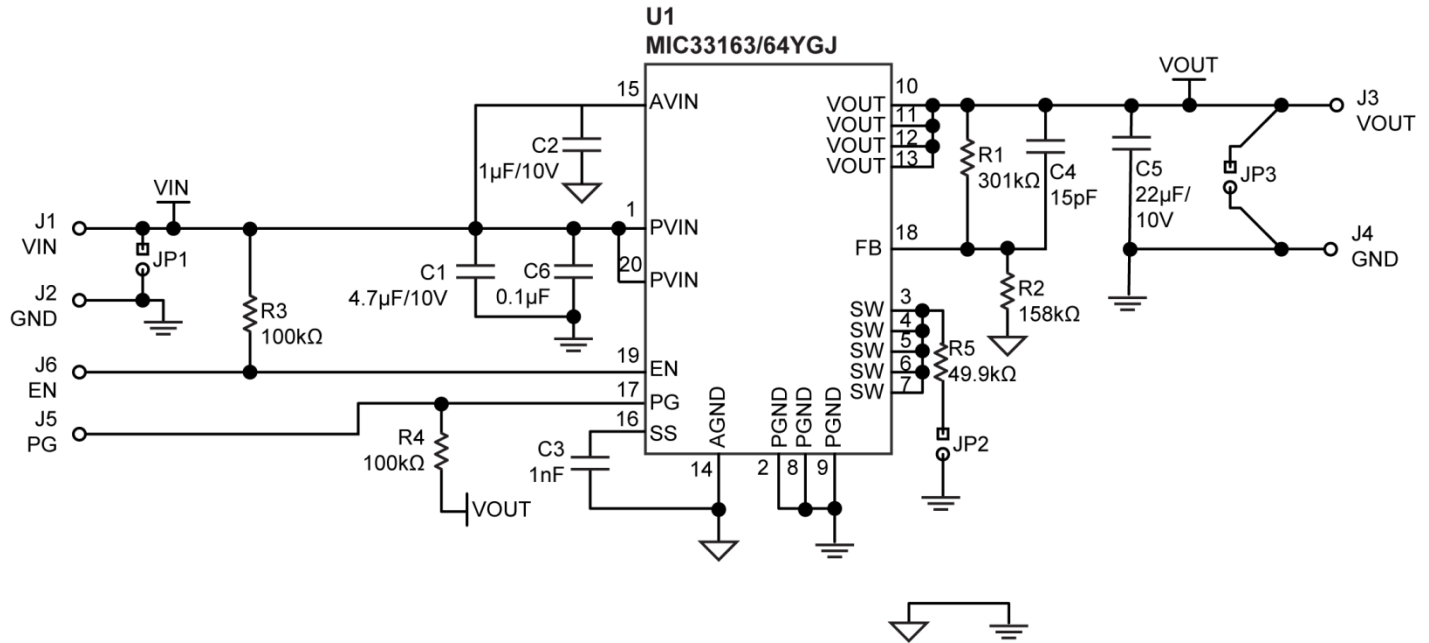

## Bill of Materials

Item	Part Number	Manufacturer	Description	Qty.
C1	C1608X5R1A475K080AC	TDK <sup>(7)</sup>	4.7μF, 10V, X5R, Size 0603	1
	GRM188R60J475KE19D	Murata <sup>(8)</sup>		
C2	C1608X5R1A105K	TDK	1μF, 10V, X5R, Size 0603	1
C3	C1005C0G1H102J050BA	TDK	1nF, 50V, 0402	1
C4	C1005C0G1H150J050BA	TDK	15pF, 50V, 0402	1
	GRM1555C1H150JZ01D	Murata		
C5	C1608X5R1A226M080AC	TDK	22μF, 10V, X5R, Size 0603	1
R1	CRCW0402301KFKEA	Vishay <sup>(9)</sup>	301kΩ, 1%, 1/16W, Size 0402	1
R2	CRCW0402158K0FKEA	Vishay	158kΩ, 1%, 1/16W, Size 0402	1
R3, R4	CRCW0402100KFKEA	Vishay	100kΩ, 1%, 1/16W, Size 0402	1
R5	CRCW040249R9FKED	Vishay	49.9Ω, 1%, 1/16W, Size 0402	1
U1	MIC33163YGJ	Micrel, Inc. <sup>(10)</sup>	4MHz, 1A, 100% Duty Cycle Buck Regulator with Integrated Inductor and HyperLight Load	1
	MIC33164YGJ			

**Notes:**

- 7. TDK: [www.tdk.com](http://www.tdk.com).
- 8. Murata: [www.murata.com](http://www.murata.com).
- 9. Vishay: [www.vishay.com](http://www.vishay.com).
- 10. Micrel, Inc.: [www.micrel.com](http://www.micrel.com).



### PCB Layout Recommendations

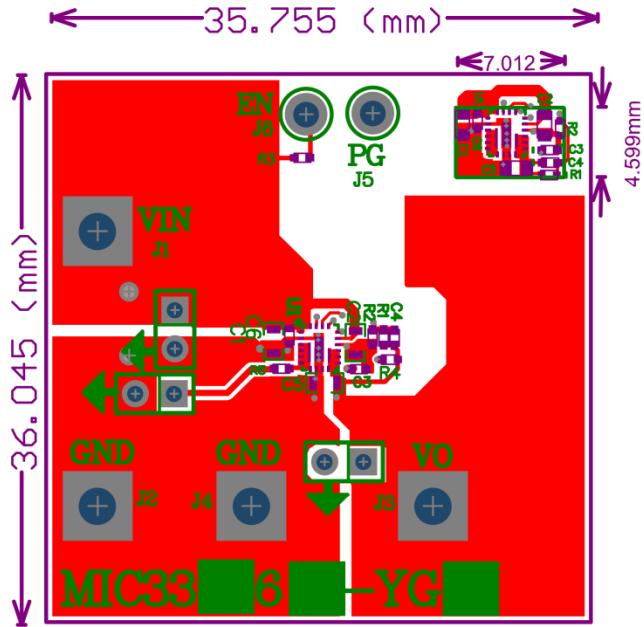

Top

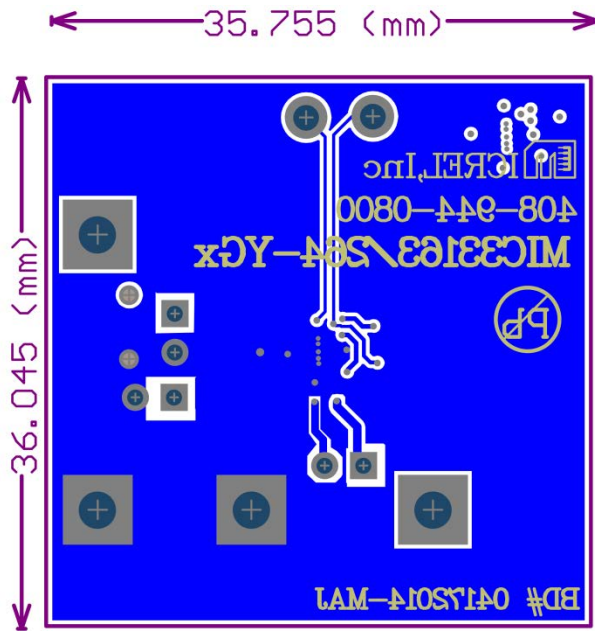

Bottom

## Package Information and Recommended Landing Pattern<sup>(11)</sup>

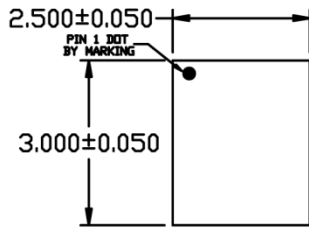

TOP VIEW  
NOTE : 1,2,3

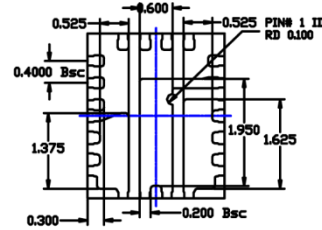

BOTTOM VIEW  
NOTE : 1,2,3

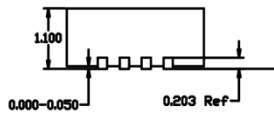

SIDE VIEW  
NOTE : 1,2,3

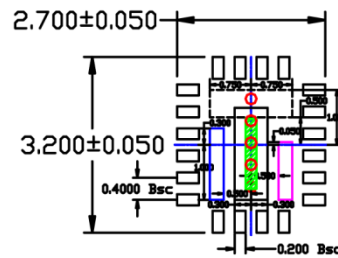

RECOMMENDED LAND PATTERN  
NOTE : 4,5,6,7

**NOTE :**

1. Max package warpage is 0.05mm.
2. Max allowable burr is 0.076mm in all directions.
3. Pin #1 will be laser marked.
4. Red circle in land pattern indicate thermal via. Size should be 0.20mm in diameter, 0.400mm pitch and should be connected to GND for max thermal performance.
5. Green rectangles (shaded area) in GND black colored pad represent stencil opening on exposed area. Size is 0.200x1.475mm.
6. Hidden lines (Optional) for improved thermal performance.
7. Blue & Magenta colored pads represent different potentials, do not connect to GND.

**20-Pin 2.5mm x 3mm QFN (GJ)**

**Note:**

11. Package information is correct as of the publication date. For updates and most current information, go to [www.micrel.com](http://www.micrel.com).

---

**MICREL, INC. 2180 FORTUNE DRIVE SAN JOSE, CA 95131 USA**TEL +1 (408) 944-0800 FAX +1 (408) 474-1000 WEB <http://www.micrel.com>

Micrel makes no representations or warranties with respect to the accuracy or completeness of the information furnished in this data sheet. This information is not intended as a warranty and Micrel does not assume responsibility for its use. Micrel reserves the right to change circuitry, specifications and descriptions at any time without notice. No license, whether express, implied, arising by estoppel or otherwise, to any intellectual property rights is granted by this document. Except as provided in Micrel's terms and conditions of sale for such products, Micrel assumes no liability whatsoever, and Micrel disclaims any express or implied warranty relating to the sale and/or use of Micrel products including liability or warranties relating to fitness for a particular purpose, merchantability, or infringement of any patent, copyright or other intellectual property right.

Micrel Products are not designed or authorized for use as components in life support appliances, devices or systems where malfunction of a product can reasonably be expected to result in personal injury. Life support devices or systems are devices or systems that (a) are intended for surgical implant into the body or (b) support or sustain life, and whose failure to perform can be reasonably expected to result in a significant injury to the user. A Purchaser's use or sale of Micrel Products for use in life support appliances, devices or systems is a Purchaser's own risk and Purchaser agrees to fully indemnify Micrel for any damages resulting from such use or sale.

© 2014 Micrel, Incorporated.