



## Complete High-Speed CMOS 12-Bit ADC

MAX162/MX7572

### General Description

The MAX162 and MX7572 are complete 12-Bit analog-to-digital converters (ADC's) that combine high speed, low power consumption, and an on-chip voltage reference. The conversion times are 3 $\mu$ s (MAX162) and 5 and 12 $\mu$ s (MX7572). The buried zener reference provides low drift and low noise performance.

External component requirements are limited to only decoupling capacitors for the power supply and reference voltages. On-chip clock circuitry is also included which can either be driven from an external source, or in stand-alone applications, can be used with a crystal.

The MAX162/MX7572 uses a standard microprocessor interface architecture. Three-state data outputs are controlled by Read (RD) and Chip Select (CS) inputs. Data access and bus release times of 90 and 75ns respectively ensure compatibility with most popular microprocessors without resorting to wait states.

### Applications

- Digital Signal Processing (DSP)
- High Accuracy Process Control
- High Speed Data Acquisition
- Electro-Mechanical Systems

### Functional Diagram

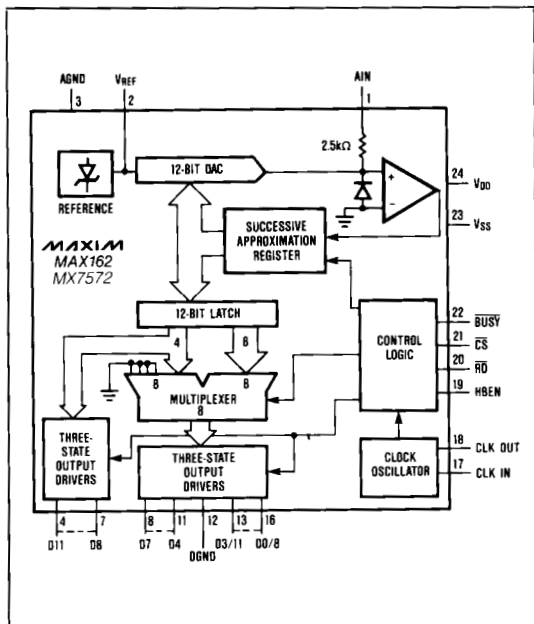

### Features

- ◆ 12-Bit Resolution and Linearity
- ◆ 3 $\mu$ s (MAX162), 5 $\mu$ s and 12 $\mu$ s (MX7572) Conversion Times
- ◆ No missing Codes
- ◆ On-Chip Voltage Reference
- ◆ 90ns Access Time
- ◆ 215mW Max Power Consumption
- ◆ 24-Lead Narrow DIP Package

### Ordering Information

PART	TEMP. RANGE	PACKAGE*	ERROR
<b>3<math>\mu</math>s CONVERSION TIME</b>			
MAX162ACNG	0°C to +70°C	Plastic DIP	$\pm 1/2$ LSB
MAX162BCNG	0°C to +70°C	Plastic DIP	$\pm 1$ LSB
MAX162CCNG	0°C to +70°C	Plastic DIP	$\pm 1$ LSB
MAX162ACWG	0°C to +70°C	Wide S.O.	$\pm 1/2$ LSB
MAX162BCWG	0°C to +70°C	Wide S.O.	$\pm 1$ LSB
MAX162CCWG	0°C to +70°C	Wide S.O.	$\pm 1$ LSB
MAX162CC/D	0°C to +70°C	Dice**	$\pm 1$ LSB
MAX162AING	-25°C to +85°C	Plastic DIP	$\pm 1/2$ LSB
MAX162BING	-25°C to +85°C	Plastic DIP	$\pm 1$ LSB
MAX162CING	-25°C to +85°C	Plastic DIP	$\pm 1$ LSB
MAX162AMRG	-55°C to +125°C	CERDIP	$\pm 1/2$ LSB
MAX162BMRG	-55°C to +125°C	CERDIP	$\pm 1$ LSB
MAX162CMRG	-55°C to +125°C	CERDIP	$\pm 1$ LSB

\* All devices — 24 lead packages  
 \*\* Consult factory for dice specifications  
 Ordering Information continued on last page.

### Pin Configuration

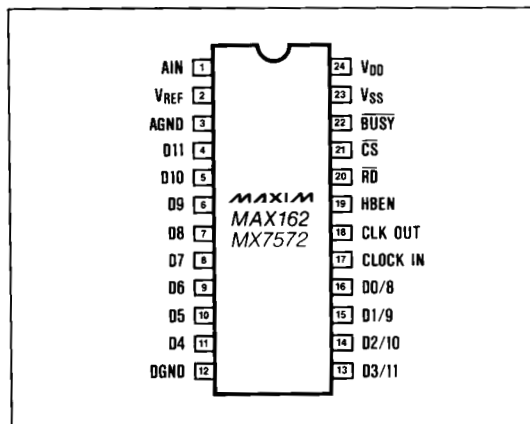

# Complete High-Speed CMOS 12-Bit ADC

## ABSOLUTE MAXIMUM RATINGS

V <sub>DD</sub> to DGND	-0.3V to +7V
V <sub>SS</sub> to DGND	+0.3V to -17V
AGND to DGND	-0.3V, V <sub>DD</sub> + 0.3V
AIN to AGND	-15V to +15V
Digital Input Voltage to DGND (Pins 17, 19-21)	-0.3V, V <sub>DD</sub> + 0.3V
Digital Output Voltage to DGND (pins 4-11, 13-16, 18, 22)	-0.3V, V <sub>DD</sub> + 0.3V

Operating Temperature Ranges	
MAX162XC, MX7572JN, KN, LN, JCWG, KCWG, LCWG	0°C to +70°C
MAX162XI, MX7572AQ, BQ, CQ	-25°C to +85°C
MAX162XM, MX7572SQ, TQ, UQ	-55°C to +125°C
Storage Temperature Range	-65°C to +160°C
Power Dissipation (any Package) to +75°C	1000mW
Derates Above +75°C by	10mW/°C
Lead Temperature (Soldering 10 seconds)	+300°C

Stresses above those listed under "Absolute Maximum Ratings" may cause permanent damage to the device. These are stress ratings only, and functional operation of the device at these or any other conditions above those indicated in the operational sections of the specifications is not implied. Exposure to absolute maximum ratings conditions for extended periods may affect device reliability.

## ELECTRICAL CHARACTERISTICS

(V<sub>DD</sub> = +5V ±5%, V<sub>SS</sub> = -15V ±5%; Slow Memory Mode; T<sub>A</sub> = T<sub>MIN</sub> to T<sub>MAX</sub> unless otherwise noted.  
f<sub>CLK</sub> = 4MHz for MAX162, 2.5MHz for MX7572XX05 and 1MHz for MX7572XX12)

PARAMETER	SYMBOL	CONDITIONS	MIN	TYP	MAX	UNITS
<b>ACCURACY</b>						
Resolution			12			Bits
Integral Non-Linearity	INL	MAX162A, MX7572L/C/U	T <sub>A</sub> = 25°C		±1/2	LSB
		MAX162AC, AI, MX7572L/C MAX162AM, MX7572U MAX162B/C, MX7572K/B/T/J/A/S			±1/2 ±3/4 ±1	
Differential Non-Linearity	DNL	Guaranteed Monotonic Over Temp.			±1	LSB
Offset Error (Note 1)		MAX162C, MX7572J/A/S	T <sub>A</sub> = 25°C T <sub>A</sub> = T <sub>MIN</sub> to T <sub>MAX</sub>		±4 ±6	LSB
		MAX162B, MX7572K/B/T	T <sub>A</sub> = 25°C T <sub>A</sub> = T <sub>MIN</sub> to T <sub>MAX</sub>		±3 ±5	
		MAX162A, MX7572L/C/U	T <sub>A</sub> = 25°C T <sub>A</sub> = T <sub>MIN</sub> to T <sub>MAX</sub>		±3 ±4	
Full Scale Error (Note 2)		MAX162C, MX7572J/A/S	T <sub>A</sub> = 25°C		±15	LSB
		MAX162B, MX7572K/B/T	T <sub>A</sub> = 25°C		±10	
		MAX162A, MX7572L/C/U	T <sub>A</sub> = 25°C		±10	
Full Scale Tempco (Notes 3, 4)		MAX162C, MX7572J/A/S MAX162B/A, MX7572K/B/T, MX7572L/C/U			±45 ±25	ppm/°C
<b>ANALOG INPUT</b>						
Input Voltage Range		For Bipolar Input see Figures 19-21	0		5	V
Input Current		A <sub>IN</sub> = 0V to +5V			3.5	mA
<b>INTERNAL REFERENCE</b>						
V <sub>REF</sub> Output Voltage		T <sub>A</sub> = 25°C	-5.2	-5.25	-5.3	V
V <sub>REF</sub> Output Tempco (Note 5)		MAX162C, MX7572J/A/S MAX162B/A, MX7572K/B/T, MX7572L/C/U		40 20		ppm/°C
Output Current Sink Capability		(Note 6)			500	µA

# Complete High-Speed CMOS 12-Bit ADC

MAX162/MX7572

## ELECTRICAL CHARACTERISTICS (Continued)

(V<sub>DD</sub> = +5V ±5%, V<sub>SS</sub> = -15V ±5%; Slow Memory Mode; T<sub>A</sub> = T<sub>MIN</sub> to T<sub>MAX</sub> unless otherwise noted.  
f<sub>CLK</sub> = 4MHz for MAX162, 2.5MHz for MX7572XX05 and 1MHz for MX7572XX12)

PARAMETER	SYMBOL	CONDITIONS	MIN	TYP	MAX	UNITS
<b>POWER SUPPLY REJECTION</b>						
V <sub>DD</sub> Only		FS Change, V <sub>SS</sub> = -15V, V <sub>DD</sub> = 4.75 to 5.25V		±1/2		LSB
V <sub>SS</sub> Only		FS Change, V <sub>DD</sub> = 5V MAX162/MX7572 MAX162	V <sub>SS</sub> = -14.25V to -15.75V V <sub>SS</sub> = -11.4V to -12.6V	±1/8 ±1/8		LSB LSB
<b>LOGIC INPUTS</b>						
Input Low Voltage	V <sub>IL</sub>	CS, RD, HBEN, CLKIN			0.8	V
Input High Voltage	V <sub>IH</sub>	CS, RD, HBEN, CLKIN	2.4			V
Input Capacitance (Note 7)	C <sub>IN</sub>	CS, RD, HBEN, CLKIN			10	pF
Input Current	I <sub>IN</sub>	CS, RD, HBEN, CLKIN	VIN = 0 to V <sub>DD</sub>		±10 ±20	μA
<b>LOGIC OUTPUTS</b>						
Output Low Voltage	V <sub>OL</sub>	D11-D0/8, BUSY, CLKOUT	I <sub>SINK</sub> = 1.6mA		0.4	V
Output High Voltage	V <sub>OH</sub>	D11-D0/8, BUSY, CLKOUT	I <sub>SOURCE</sub> = 200μA		4	V
Floating State Leakage Current	I <sub>LKG</sub>	D11-D0/8, V <sub>OUT</sub> = 0V to V <sub>DD</sub>			±10	μA
Floating State Output Capacitance (Note 7)	C <sub>OUT</sub>				15	pF
<b>CONVERSION TIME</b>						
MAX162	t <sub>CONV</sub>	f <sub>CLK</sub> = 4MHz	Synchronous (13 clock cycles) Asynchronous (12 to 13 clock cycles)	3	3.25	μs
MX7572XX05	t <sub>CONV</sub>	f <sub>CLK</sub> = 2.5MHz	Synchronous (12.5 clock cycles) Asynchronous (12 to 13 clock cycles)	4.8	5.2	μs
MX7572XX12	t <sub>CONV</sub>	f <sub>CLK</sub> = 1MHz	Synchronous (12.5 clock cycles) Asynchronous (12 to 13 clock cycles)	12	13	μs
<b>POWER REQUIREMENTS</b>						
V <sub>DD</sub>		±5% for Specified Performance	4.75	5	5.25	V
V <sub>SS</sub> (Note 8)		±5% MAX162 ±5% MX7572		-12 or -15 -15		V
I <sub>DD</sub>		CS = RD = V <sub>DD</sub> , AIN = 5V		5	7	mA
I <sub>SS</sub>		CS = RD = V <sub>DD</sub> , AIN = 5V		8	12	mA
Power Dissipation		V <sub>DD</sub> = +5V, V <sub>SS</sub> = -15V		145	215	mW

**Note 1:** Typical change over temp is ±1LSB

**Note 2:** V<sub>DD</sub> = +5V, V<sub>SS</sub> = -15V, FS = +5.000V, Ideal last code transition = FS - 3/2LSB

**Note 3:** Full Scale TC = ΔFS/ΔT, where ΔFS is full scale change from T<sub>A</sub> = 25°C to T<sub>MIN</sub> or T<sub>MAX</sub>.

**Note 4:** Includes internal reference drift.

**Note 5:** V<sub>REF</sub> TC = ΔV<sub>REF</sub>/ΔT, where ΔV<sub>REF</sub> is reference voltage change from T<sub>A</sub> = 25°C to T<sub>MIN</sub> or T<sub>MAX</sub>.

**Note 6:** Output current should not change during conversion.

**Note 7:** Guaranteed by design, not subject to test.

**Note 8:** V<sub>SS</sub> = -12V ±5% for the MAX162 only. Functional operation is guaranteed by testing offset error and full scale error.

## Complete High-Speed CMOS 12-Bit ADC

### TIMING CHARACTERISTICS (Note 9)

( $V_{DD} = +5V$ ,  $V_{SS} = -15V$ ;  $T_A = T_{MIN}$  to  $T_{MAX}$  unless otherwise noted.)

PARAMETER	SYMBOL	CONDITIONS	$T_A = 25^\circ\text{C}$			MAX162C/I MX7572J/K/L MX7572A/B/C		MAX162M MX7572S/T/U		UNITS
			MIN	TYP	MAX	MIN	MAX	MIN	MAX	
CS to RD Setup Time	$t_1$		0			0		0		ns
RD to BUSY Delay	$t_2$	$C_L = 50\text{pF}$		90	190		230		270	ns
Data Access Time (Note 10)	$t_3$	$C_L = 20\text{pF}$ $C_L = 100\text{pF}$		60	90		110		120	ns
RD Pulse Width	$t_4$			$t_3$		$t_3$		$t_3$		
CS to RD Hold Time	$t_5$		0			0		0		ns
Data Setup Time After BUSY Note (10)	$t_6$				70		90		100	ns
Bus Relinquish Time (Note 11)	$t_7$		20		75	20	85	20	90	ns
HBEN to RD Setup Time	$t_8$		0			0		0		ns
HBEN to RD Hold Time	$t_9$		0			0		0		ns
Delay Between Read Operations	$t_{10}$		200			200		200		ns

**Note 9:** Timing specifications are sample tested at  $25^\circ\text{C}$  to ensure compliance. All input control signals are specified with  $t_r = t_f = 5\text{ns}$  (10% to 90% of +5V) and timed from a voltage level of +1.6V.

**Note 10:**  $t_3$  and  $t_6$  are measured with the load circuits of Figure 1 and defined as the time required for an output to cross 0.8V or 2.4V.

**Note 11:**  $t_7$  is defined as the time required for the data lines to change 0.5V when loaded with the circuits of Figure 2.

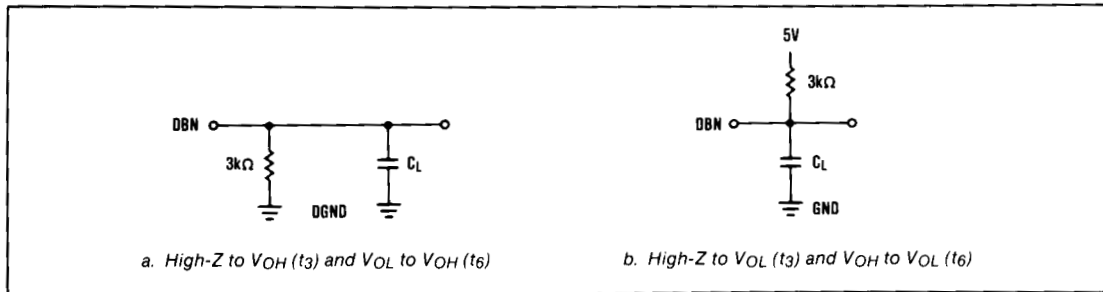

Figure 1. Load Circuits for Access Time

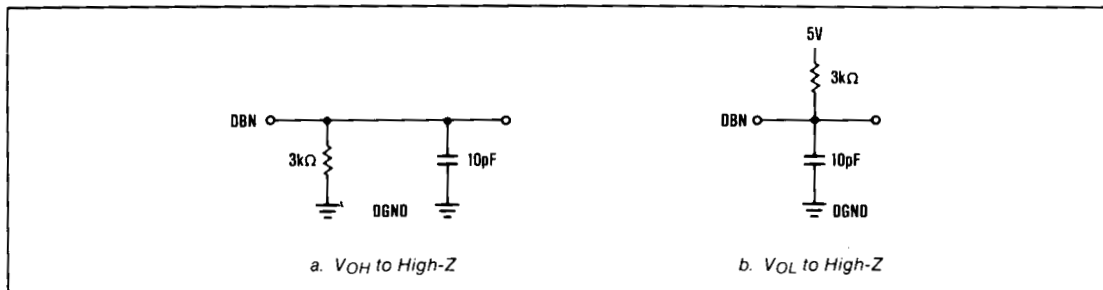

Figure 2. Load Circuits for Output Float Delay

# Complete High-Speed CMOS 12-Bit ADC

## Pin Description

MAX162/MX7572

PIN	NAME	FUNCTION
1	AIN	Analog Input, 0 to +5V unipolar input
2	V <sub>REF</sub>	-5.25V Reference Output
3	AGND	Analog Ground
4-11	D11-D4	Three-State Data Outputs
12	DGND	Digital Ground
13-16	D3/11-D0/8	Three-State Data Outputs
17	CLKIN	Clock Input. An external TTL/CMOS compatible clock may be applied to this pin or a crystal can be connected between CLKIN and CLKOUT.
18	CLKOUT	Clock Output. An inverted CLKIN signal appears at this pin.

PIN	NAME	FUNCTION
19	HBEN	High Byte Enable Input. This pin is used to multiplex the internal 12-bit conversion result into the lower bit outputs (D7-D0/8). HBEN also disables conversion starts when HIGH.
20	$\overline{RD}$	READ Input. This active low signal starts a conversion when CS and HBEN are low. RD also enables the output drivers when CS is low.
21	$\overline{CS}$	The CHIP SELECT Input must be low for the ADC to recognize RD and HBEN inputs.
22	$\overline{BUSY}$	The BUSY Output is low when a conversion is in progress.
23	V <sub>SS</sub>	Negative Supply, -15V for MX7572 and -15V or -12V for MAX162.
24	V <sub>DD</sub>	Positive Supply, +5V

### Data Bus Output, $\overline{CS}$ & $\overline{RD}$ = LOW

	Pin 4	Pin 5	Pin 6	Pin 7	Pin 8	Pin 9	Pin 10	Pin 11	Pin 13	Pin 14	Pin 15	Pin 16
MNEMONIC*	D11	D10	D9	D8	D7	D6	D5	D4	D3/11	D2/10	D1/9	D0/8
HBEN = LOW	DB11	DB10	DB9	DB8	DB7	DB6	DB5	DB4	DB3	DB2	DB1	DB0
HBEN = HIGH	DB11	DB10	DB9	DB8	LOW	LOW	LOW	LOW	DB11	DB10	DB9	DB8

#### Note:

- \* D11 ... D0/8 are the ADC data output pins.
- DB11 ... DB0 are the 12-bit conversion results, DB11 is the MSB.

## Converter Operation

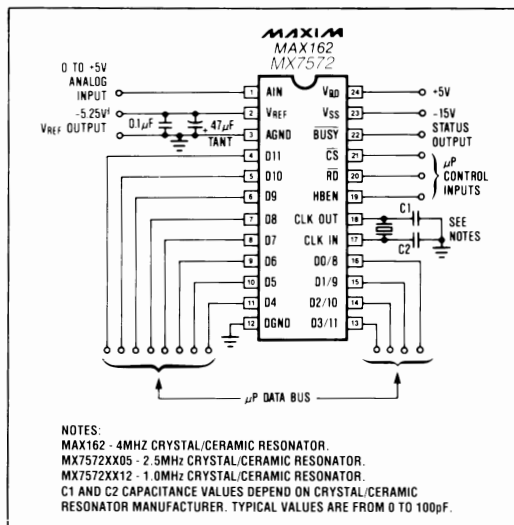

Figure 3. MAX162/MX7572 Operational Diagram

The MAX162 and MX7572 use a successive approximation technique to convert an unknown analog input to a 12 bit digital output code. The control logic provides easy interface to most microprocessors. Most applications require only a few external passive components to perform the analog-to-digital function. Figure 3 shows the MAX162/MX7572 in its simplest operational configuration.

Figure 4 shows the MAX162/MX7572 analog equivalent circuit. The internal voltage output DAC is controlled by a successive approximation register (SAR) and has an output impedance of 2.5kΩ. The analog input is connected to the DAC output with a 2.5kΩ resistor. The comparator is essentially a zero crossing detector and its output is fed back to the SAR input.

Conversion start is controlled by the CS, RD and HBEN digital inputs. A conversion starts at the falling edge of CS and RD while HBEN is low. Once started, conversion cannot be stopped. The BUSY output goes low as soon as the conversion starts. BUSY may be used to control an external sample-and-hold when wide bandwidth input signals are being measured.

# Complete High-Speed CMOS 12-Bit ADC

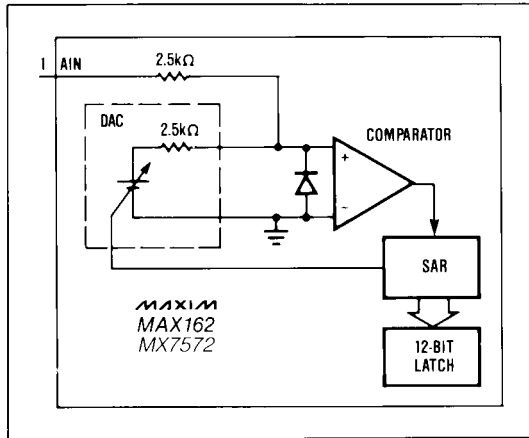

Figure 4. MAX162/MX7572 Analog Equivalent Circuit

The SAR is set to half scale as soon as the CS and RD inputs go low. This reset is asynchronous with the clock input. The analog input is then compared to one half of the full scale voltage. About 30ns after the second falling edge of CLKIN (or rising edge of CLKOUT), the output of the comparator is latched into the SAR MSB bit (see Figure 5). The bit is kept if the analog input is greater than half scale, or dropped if it is smaller. The next bit (bit 11) is then set with the DAC output either at 1/4 scale (if the MSB was dropped) or 3/4 scale (if the MSB was kept). The conversion continues in this manner until the LSB is tried. Following a falling CLKIN signal, the BUSY output goes high and the SAR result is latched into the three-state output buffers.

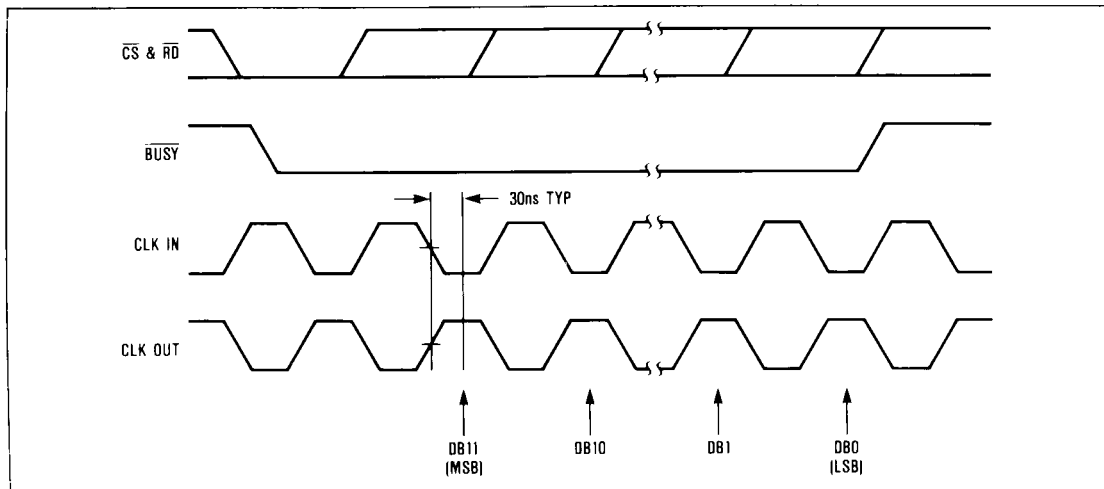

Figure 5. Operating Waveforms Using an External Clock Source for CLKIN.

## Clock Operation

### Clock Oscillator

Figure 6 shows the MAX162/MX7572 clock circuitry. The capacitive load on the CLKOUT pin must be minimized for low power dissipation and to avoid digital coupling of the CLKOUT buffer currents to the comparator. If an external clock source is being used to drive CLKIN, CLKOUT should be left open. The external clock source must have a 50% duty cycle. If the internal oscillator is being used, a crystal/ceramic resonator should be connected between CLKOUT and CLKIN as shown in Figure 6.

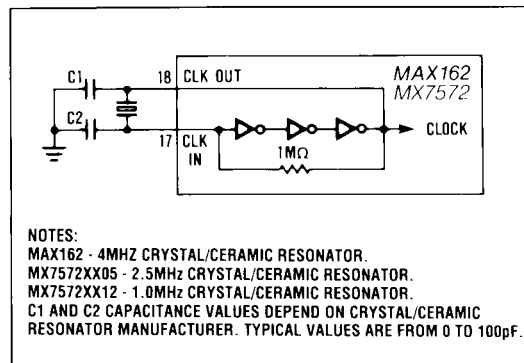

Figure 6. MAX162/MX7572 Internal Clock Circuit

# Complete High-Speed CMOS 12-Bit ADC

## Control Input Synchronization

MX7572

In applications where the  $\overline{RD}$  control input is not synchronized with the ADC clock, the conversion time can vary from 12 to 13 clock cycles. The SAR changes state on the falling edge of the CLKIN input (or rising edge on the CLKOUT pin). To ensure a fixed conversion time use the following guidelines for synchronization:

### MAX162

For the MAX162 the  $\overline{RD}$  input should go low at the falling edge of CLKIN. In this case the conversion lasts 13 clock cycles and the conversion time is  $3.25\mu\text{s}$  when  $f_{\text{CLK}} = 4\text{MHz}$ . If the CLKIN and  $\overline{RD}$  falling edges are skewed, the skew must not be more than 50ns to ensure the 13 period conversion time (See Figure 7). The MSB is tried at the second clock falling edge, leaving two clock cycles for the external sample-and-hold to settle from hold transients.

The MX7572  $\overline{RD}$  input can go low at the rising edge of CLKIN. In this case the conversion lasts 12.5 clock cycles and the conversion time is  $5\mu\text{s}$  when  $f_{\text{CLK}} = 2.5\text{MHz}$  and  $12.5\mu\text{s}$  when  $f_{\text{CLK}} = 1\text{MHz}$ . The delay from the falling edge of  $\overline{RD}$  to the falling edge of CLKIN must not be less than 180ns to ensure the 12.5 clock cycle conversion time (See Figure 8). This leaves the external sample-and-hold 1.5 clock cycles to settle from hold transients. An additional half clock cycle of settling can be allowed for driving the sample-and-hold by having  $\overline{RD}$  go low at the falling edge of CLKIN, similar to the MAX162. This results in a 13 cycle conversion time ( $5.2\mu\text{s}$  when  $f_{\text{CLK}} = 2.5\text{MHz}$ ,  $13\mu\text{s}$  when  $f_{\text{CLK}} = 1\text{MHz}$ ).

MAX162/MX7572

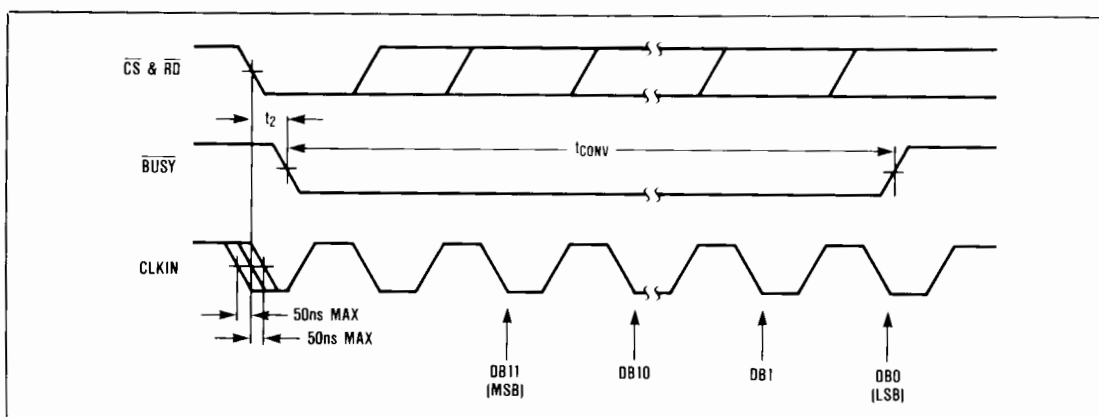

Figure 7. MAX162  $\overline{RD}$  and CLKIN For Synchronous Operation

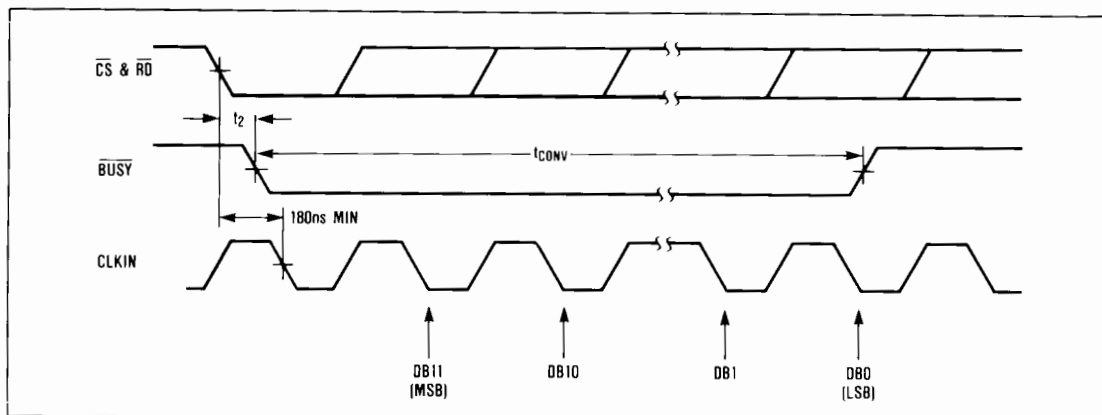

Figure 8. MX7572  $\overline{RD}$  and CLKIN For Synchronous Operation

## Complete High-Speed CMOS 12-Bit ADC

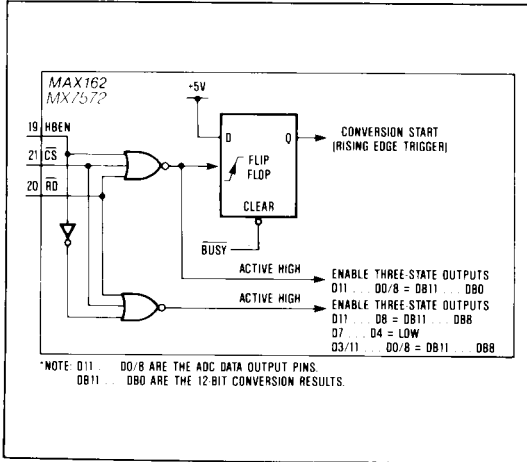

Figure 9. Logic Equivalent for  $\overline{RD}$ ,  $\overline{CS}$  and HBEN Inputs

### Digital Interface

#### Output Data Format

The 12 output data bits can either be presented full parallel or in two 8 bit words. To obtain parallel output for 16 bit processors, HBEN should be kept low and the output data D11-D0 will be right justified.

For a two byte data read, outputs D7-D0/8 are used. Byte selection is controlled by HBEN which multiplexes the data outputs. When HBEN is low, the lower 8 bits are presented at the data outputs. When HBEN is high, the upper 4 bits are presented with the leading 4 bits being low for D7-D0/8.

Note that the 4 MSB's always appear at digital outputs D11-D8 whenever the digital drivers are enabled, regardless of the state of HBEN.

#### Timing and Control

Conversion start and data read operations are controlled by three digital inputs; HBEN, CS and RD. Figure 9 shows the logic equivalent for the conversion and data output control circuitry. A logic low is required on all three inputs to start a conversion. Once a conversion is in progress, it cannot be re-started. The BUSY output is low during the entire conversion cycle.

There are two modes of operation as outlined in the timing diagrams of Figures 10-13. Slow memory mode is intended for processors that can be forced into a WAIT state for periods as long as the MAX162/MX7572 conversion time. ROM mode is for processors that cannot be forced into a wait state. In both operational modes, a processor READ operation to the ADC address starts the conversion. In the ROM mode, a second READ operation is required to access the conversion result.

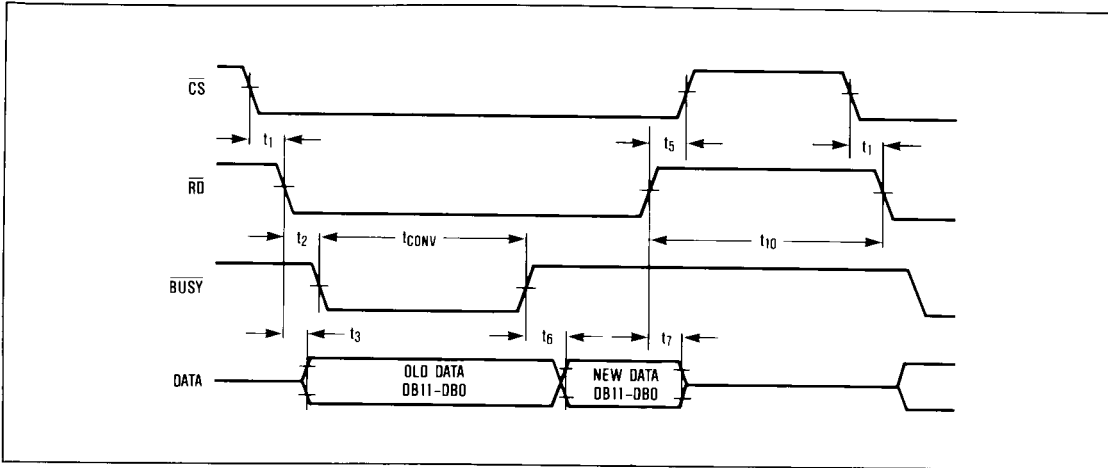

Figure 10. Slow Memory Mode, Parallel Read Timing Diagram

Table 1. Slow Memory Mode, Parallel Read Data Bus Status

MAX162/MX7572 Data Outputs	D11	D10	D9	D8	D7	D6	D5	D4	D3/11	D2/10	D1/9	D0/8
Read	DB11	DB10	DB9	DB8	DB7	DB6	DB5	DB4	DB3	DB2	DB1	DB0



# Complete High-Speed CMOS 12-Bit ADC

**MAX162/MX7572**

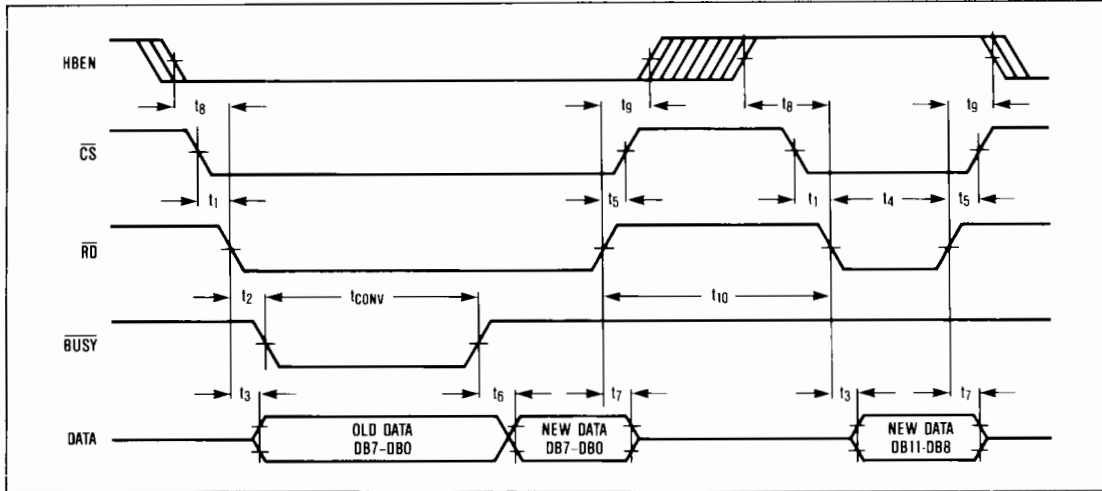

Figure 11. Slow Memory Mode, Two Byte Read Timing Diagram

**Table 2. Slow Memory Mode, Two Byte Read Data Bus Status**

MAX162/MX7572 Data Outputs	D7	D6	D5	D4	D3/11	D2/10	D1/9	D0/8
First Read	DB7	DB6	DB5	DB4	DB3	DB2	DB1	DB0
Second Read	LOW	LOW	LOW	LOW	DB11	DB10	DB9	DB8

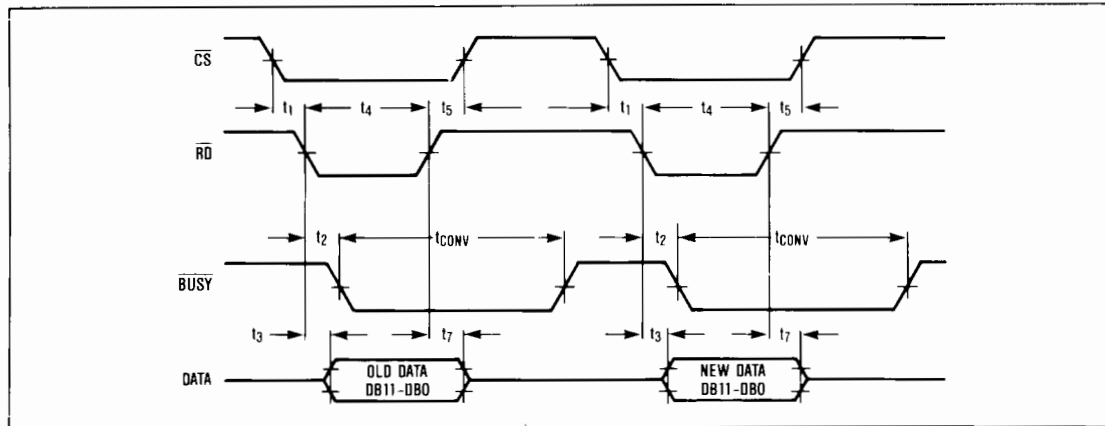

Figure 12. ROM Mode, Parallel Read Timing Diagram

**Table 3. ROM Mode, Parallel Read Data Bus Status**

MAX162/MX7572 Data Outputs	D11	D10	D9	D8	D7	D6	D5	D4	D3/11	D2/10	D1/9	D0/8
First Read (Old Data)	DB11	DB10	DB9	DB8	DB7	DB6	DB5	DB4	DB3	DB2	DB1	DB0
Second Read	DB11	DB10	DB9	DB8	DB7	DB6	DB5	DB4	DB3	DB2	DB1	DB0

## Complete High-Speed CMOS 12-Bit ADC

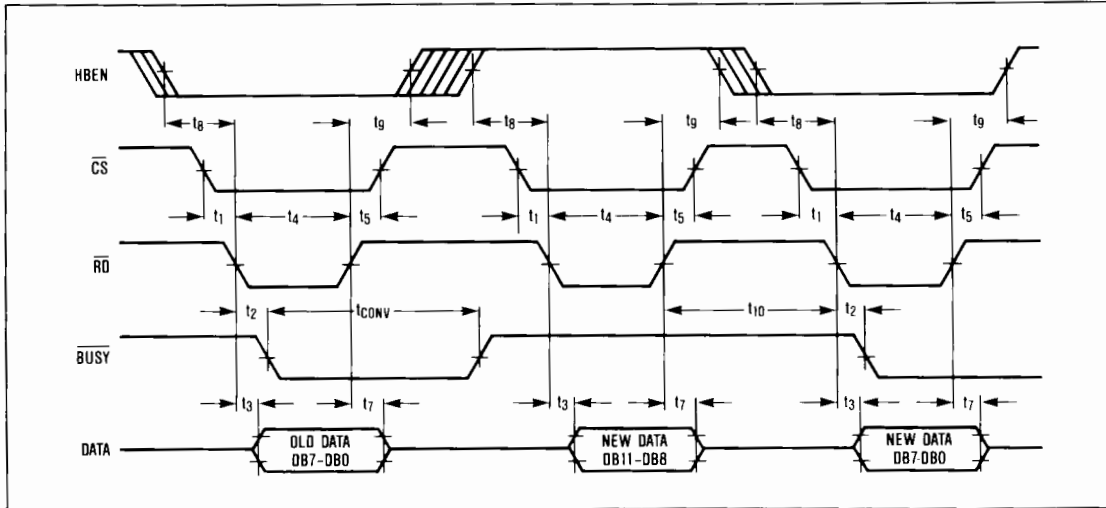

Figure 13. ROM Mode, Two Byte Read Timing Diagram

Table 4. ROM Mode, Two Byte Read Data Bus Status

MAX162/MX7572 Data Outputs	D7	D6	D5	D4	D3/11	D2/10	D1/9	D0/8
First Read (Old Data)	DB7	DB6	DB5	DB4	DB3	DB2	DB1	DB0
Second Read	LOW	LOW	LOW	LOW	DB11	DB10	DB9	DB8
Third Read	DB7	DB6	DB5	DB4	DB3	DB2	DB1	DB0

### Slow Memory Mode, Parallel Read (HBEN = LOW)

Figure 10 and Table 1 show the timing diagram and data bus status for Slow Memory Mode, Parallel Read. CS and RD going low starts the conversion and BUSY goes low indicating that the conversion is in progress. Data from the previous conversion appears at the digital outputs. At the end of the conversion, BUSY returns high and the output latches are updated to place the digital conversion result on data outputs D11-D0/8.

### Slow Memory Mode, Two Byte Read

For a two byte read, only outputs D7-D0/8 are used. Starting the conversion and reading the 8 LSB's is identical to the Slow Memory Mode, Parallel Read. See Figure 11 and Table 2. A second READ operation with HBEN high places the 4 MSB's with 4 leading zeros on the data outputs D7-D0/8. The high byte read does not start another conversion since HBEN is high.

### ROM Mode, Parallel Read (HBEN = LOW)

The ROM mode avoids placing the processor into a wait state. A conversion is started with a READ operation and the 12-bits of data from the previous conversion appears at the data outputs D11-D0/8 (see Figure 12 and Table 3). This data may be disregarded if not needed. A second READ operation will access the results of the first operation and also start a new conversion. The delay between successive READ operations must be longer than the conversion time for the MAX162/MX7572.

### ROM Mode, Two Byte Read

As in the Slow Memory Mode, only data outputs D7-D0/8 should be used for two byte reads. Figure 13 and Table 4 show the operation in this mode. A conversion is started with a READ operation with HBEN low. The data outputs present the 8 LSB's from the previous conversion and this data can be disregarded if not required. Two more READ operations are needed to access the conversion result. The first READ must be with HBEN high, where the 4 MSB's with 4 leading zero's are accessed. The second READ is with HBEN low, which reads in the 8 LSB's and starts a new conversion.

# Complete High-Speed CMOS 12-Bit ADC

MAX162/MX7572

## Interface Application Hints

### Digital Bus Noise

If the data bus connected to the ADC is active during a conversion, LSBs of error can be caused due to coupling from the data pins to the ADC comparator. Using the Slow Memory Mode avoids this problem by placing the processor in a wait state during the conversion. In the ROM mode, if the data bus is going to be active during the conversion, the bus should be isolated from the ADC using three-state drivers.

### ROM Mode

Considerable digital noise is generated in the ADC when RD or CS go high and the output data drivers are disabled after a conversion is started. This noise will feed into the ADC comparator and cause large errors if it coincides with the time the SAR is latching a decision to keep or drop a bit. To avoid this problem, RD and CS should be active for less than one clock cycle. In other words, the RD and CS low pulse should be shorter than 250ns for the MAX162, 400ns for the MX7572XX05 and 1 $\mu$ s for the MX7572XX12. If this cannot be done, the RD or CS signal must go high at a rising edge of CLKIN, since the comparator output is always latched at falling edges of CLKIN.

## Analog Considerations

### Application Hints

#### Physical Layout

For best system performance printed circuit boards should be used for the MAX162/MX7572. Wire wrap boards are not recommended. The layout of the board should ensure that digital and analog signal lines are kept separated from each other as much as possible. Care should be taken not to run analog and digital lines parallel to each other or digital lines underneath the MAX162/MX7572 package.

## Grounding

Figure 14 shows the recommended system ground connections. A single point analog STAR ground should be established at pin 3 (AGND) of the MAX162/MX7572 separate from the logic ground. All other analog grounds and pin 12 (DGND) of the MAX162/MX7572 should be connected to this STAR ground and no other digital grounds should be connected to this STAR point. The ground return to the power supply from this STAR ground should be low impedance for noise free operation of the ADC.

### Power Supply Bypassing

The high speed comparator in the ADC is sensitive to high frequency noise in the  $V_{DD}$  and  $V_{SS}$  power supplies. These supplies should be by-passed to the analog STAR ground with 0.1 $\mu$ F and 10 $\mu$ F by-pass capacitors with minimum lead length for supply noise rejection. If the +5V power supply is very noisy, a small (10-20 ohms) resistor can be connected as shown in Figure 14 to filter external noise.

### Internal Reference

The MAX162/MX7572 has an internal buried zener reference which provides the DAC reference voltage. The reference voltage is -5.25V  $\pm$ 1% and has a low temperature coefficient. The reference output is available at pin 2, and should be bypassed to analog ground (pin 3) with a 47 $\mu$ F tantalum capacitor in parallel with 0.1 $\mu$ F capacitor to minimize noise and provide low impedance at high frequencies. This by-pass capacitor must not be less than 4.7 $\mu$ F. The internal reference output buffer can sink up to 500 $\mu$ A.

### Driving The Analog Input

The input signal leads to AGND and AIN should be as short as possible to minimize noise pick-up. If the leads must be long use shielded cables to minimize noise pick-up.

The input impedance at the AIN pin is typically 2.5k $\Omega$ . The amplifier driving AIN must have low enough DC output impedance for low gain error. Furthermore, low AC output impedance is also required since the analog input current is modulated at the clock rate during a conversion (4MHz for MAX162 and 2.5 or 1MHz for the MX7572). The output impedance of the driving amplifier is equal to its open loop output impedance divided by the loop gain at the frequency of interest.

**MX7572** The MX7572 maximum clock rate of 2.5MHz makes it possible to drive it with amplifiers like the OP-42, AD711 or OP-27. At 1MHz clock rate a MAX400 or OP-07 can also be used.

**MAX162** The MAX162 with a maximum 4MHz clock rate might cause settling problems with the above amplifiers. An LF356, LF400 or LT1056 can be used to drive the input. Alternatively, an emitter follower buffer inside the feedback loop of a OP-42, AD711 or OP-27 can be used to improve high frequency output impedance.

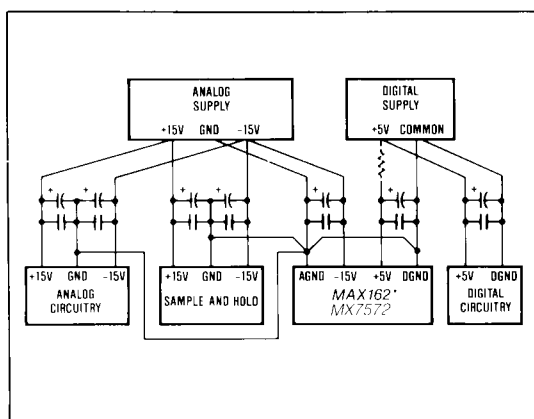

Figure 14. Power Supply Grounding Practice





# Complete High-Speed CMOS 12-Bit ADC

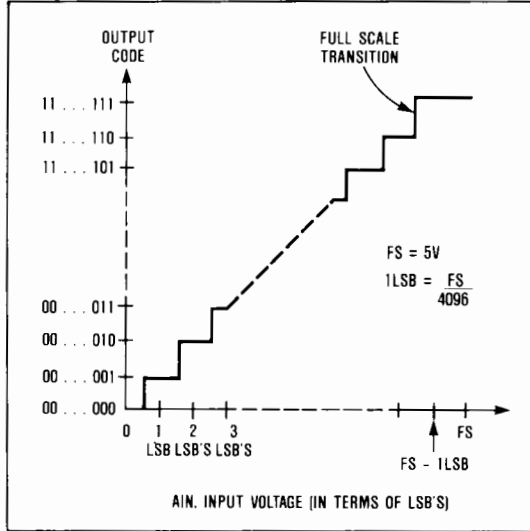

Figure 17. MAX162/MX7572 Transfer Function

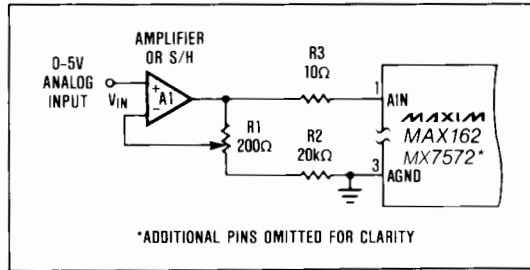

Figure 18. Full-Scale Adjustment

Figure 19 shows the bipolar operation in the non-inverting mode, where the output coding is offset binary. Figure 20 shows the ideal transfer function for this mode.

Figure 21 shows the bipolar operation in the inverting mode, where the output coding is complementary offset binary. Figure 20 shows the ideal transfer function for the circuit in Figure 21.

The resistors used in bipolar applications should be of the same type and from the same manufacturer to obtain low temperature drifts. 0.1% resistors are recommended for applications where offset and full scale adjustments must be made in bipolar circuits. If high tolerances are used, larger value potentiometers must be used and this results in poor sensitivity and higher temperature drifts.

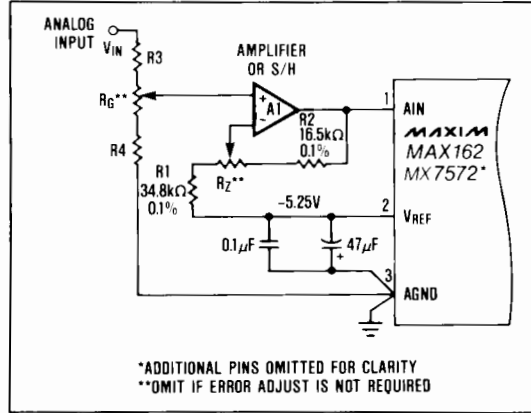

Figure 19. MAX162/MX7572 Non-inverting Bipolar Operation

Table 5. Resistor and Potentiometer Values Required for Offset and Gain Adjustment of Figure 19

V <sub>IN</sub> Range (Volts)	R3* (kΩ)	R4* (kΩ)	R <sub>Z</sub> (Ω)	R <sub>G</sub> (Ω)	1/2LSB (mV)	FS/2-3/2LSBs (Volts)
±2.5	3.83	8.25	500	500	0.61	2.49817
±5.0	33.2	16.9	500	1000	1.22	4.99634
±10.0	47.5	9.53	500	500	2.44	9.99268

Notes:  
 \* R3 and R4 have a 0.1% tolerance.  
 All resistors are standard EIA/MIL decade values.

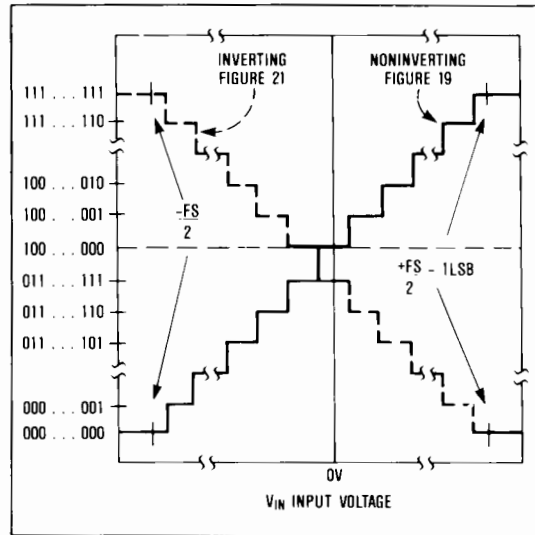

Figure 20. Ideal Input/Output Transfer Characteristic for the Bipolar circuits in Figures 19 and 21.

# Complete High-Speed CMOS 12-Bit ADC

## Offset and Full Scale Adjustment

Offset should always be adjusted before full scale. For both circuits apply  $+1/2\text{LSB}$  to the analog input (see tables 5 and 6) and adjust  $R_z$  until the output code flickers between the following codes:

For Non-inverting (Figure 19) 1000 0000 0000  
1000 0000 0001

For inverting (Figure 21) 0111 1111 1111  
0111 1111 1110

Apply  $\text{FS}-3/2\text{LSB}$  (see tables 5 and 6) to the input and adjust  $R_G$  until the ADC output code flickers between the following codes:

For Non-inverting (Figure 19) 1111 1111 1110  
1111 1111 1111

For inverting (Figure 21) 0000 0000 0001  
0000 0000 0000

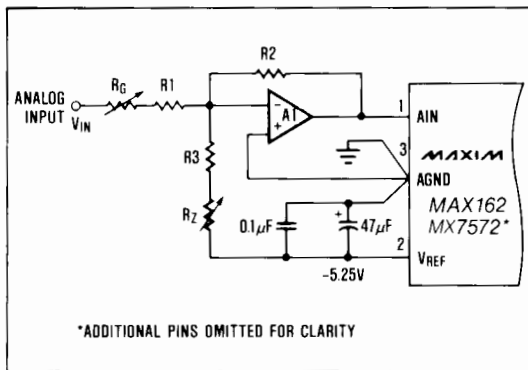
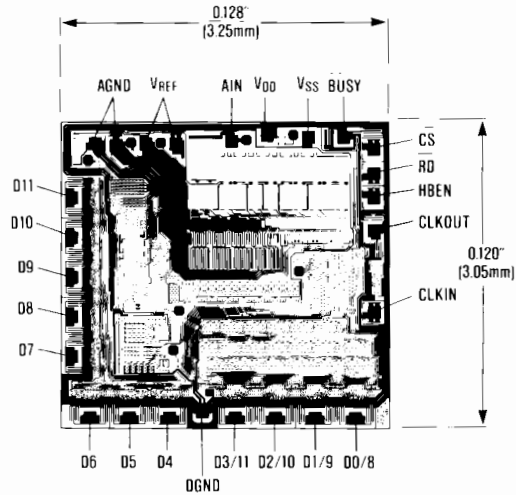

Figure 21. MAX162/MX7572 Inverting Bipolar Operation

## Chip Topography



MAX162/MX7572

Table 6. Resistor and Potentiometer Values Required for Offset and Gain Adjustment of Figure 21

$V_{IN}$ Range (Volts)	$R1^*$ (k $\Omega$ )	$R2^*$ (k $\Omega$ )	$R3^*$ (k $\Omega$ )	$R_z$ ( $\Omega$ )	$R_G$ ( $\Omega$ )	1/2LSB (mV)	FS/2-3/2LSBs (Volts)
$\pm 2.5$	20	20.5	42.2	2000	1000	0.61	2.49817
$\pm 5.0$	20	10.2	21	1000	1000	1.22	4.99634
$\pm 10.0$	20	5.11	10.5	500	1000	2.44	9.99268

### Notes:

- \*  $R1$ ,  $R2$ , and  $R3$  have a 0.1% tolerance.
- All resistors are standard EIA/MIL decade values.

## Complete High-Speed CMOS 12-Bit ADC

### Ordering Information (continued)

PART	TEMP. RANGE	PACKAGE*	ERROR
<b>5<math>\mu</math>s CONVERSION TIME</b>			
MX7572JN05	0°C to +70°C	Plastic DIP	$\pm 1$ LSB
MX7572KN05	0°C to +70°C	Plastic DIP	$\pm 1$ LSB
MX7572LN05	0°C to +70°C	Plastic DIP	$\pm \frac{1}{2}$ LSB
MX7572JCWG05	0°C to +70°C	Wide S.O.	$\pm 1$ LSB
MX7572KCWG05	0°C to +70°C	Wide S.O.	$\pm 1$ LSB
MX7572LCWG05	0°C to +70°C	Wide S.O.	$\pm \frac{1}{2}$ LSB
MX7572AQ05	-25°C to +85°C	CERDIP	$\pm 1$ LSB
MX7572BQ05	-25°C to +85°C	CERDIP	$\pm 1$ LSB
MX7572CQ05	-25°C to +85°C	CERDIP	$\pm \frac{1}{2}$ LSB
MX7572SQ05	-55°C to +125°C	CERDIP	$\pm 1$ LSB
MX7572TQ05	-55°C to +125°C	CERDIP	$\pm 1$ LSB
MX7572UQ05	-55°C to +125°C	CERDIP	$\pm \frac{1}{2}$ LSB
<b>12<math>\mu</math>s CONVERSION TIME</b>			
MX7572JN12	0°C to +70°C	Plastic DIP	$\pm 1$ LSB
MX7572KN12	0°C to +70°C	Plastic DIP	$\pm 1$ LSB
MX7572LN12	0°C to +70°C	Plastic DIP	$\pm \frac{1}{2}$ LSB
MX7572JCWG12	0°C to +70°C	Wide S.O.	$\pm 1$ LSB
MX7572KCWG12	0°C to +70°C	Wide S.O.	$\pm 1$ LSB
MX7572LCWG12	0°C to +70°C	Wide S.O.	$\pm \frac{1}{2}$ LSB
MX7572AQ12	-25°C to +85°C	CERDIP	$\pm 1$ LSB
MX7572BQ12	-25°C to +85°C	CERDIP	$\pm 1$ LSB
MX7572CQ12	-25°C to +85°C	CERDIP	$\pm \frac{1}{2}$ LSB
MX7572SQ12	-55°C to +125°C	CERDIP	$\pm 1$ LSB
MX7572TQ12	-55°C to +125°C	CERDIP	$\pm 1$ LSB
MX7572UQ12	-55°C to +125°C	CERDIP	$\pm \frac{1}{2}$ LSB

\* All devices — 24 lead packages

Maxim cannot assume responsibility for use of any circuitry other than circuitry entirely embodied in a Maxim product. No circuit patent licenses are implied. Maxim reserves the right to change the circuitry and specifications without notice at any time.