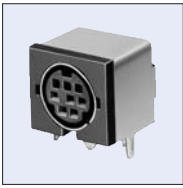
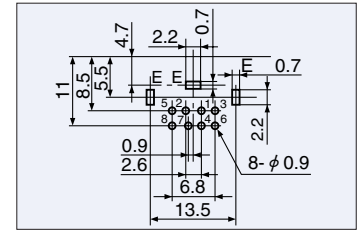
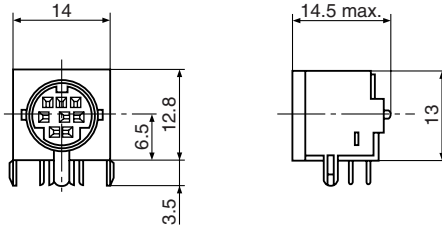

TCS71□7 Series

h=6.5mm

TCS7187-012177
EMI-Proof

 Hole Layout
(Bottom View)

TCS72□2 Series

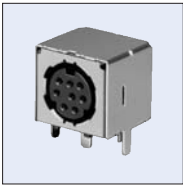
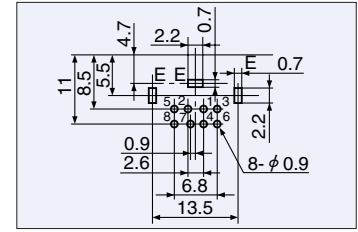
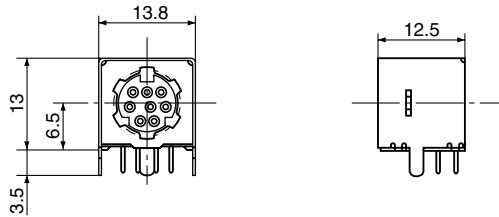
h=6.5mm

TCS7282-0121177
EMI-Proof

 Hole Layout
(Bottom View)

TCS72□6 Series

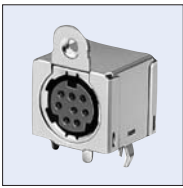
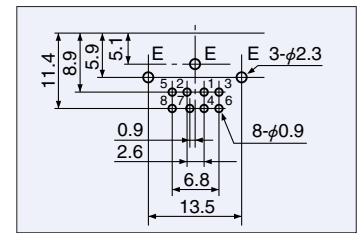
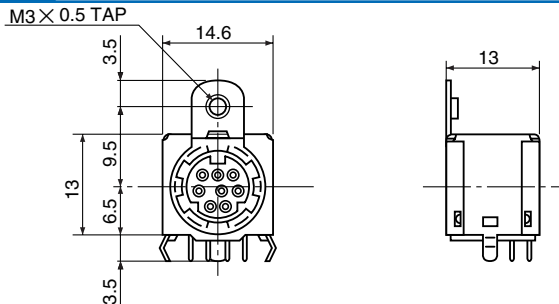
h=6.5mm

TCS7286-0124177
EMI-Proof

 Hole Layout
(Bottom View)

Notes:

1. Combinations with plugs

- ① Can be fit with the TCP7100 series.
- ② Connection with the TCP8500 series, the TCP8600 series and the TCP8300 series are possible, but some specifications are not applicable. Please inquire concerning special specification.
- ③ The combinations of the 6P socket and the 5P (a) plug, the 6P socket and the 8P (a) plug, and the 7P socket and 8P (a) plug are not designed for error connecting prevention.

Contact Arrangement	3	4	6	8a
Hole Layout (Bottom View) TCS71□7 Series				
TCS71□7 Series	TCS7137-012177	TCS7147-012177	TCS7167-012177	TCS7187-012177
Contact Arrangement	4	5a	6	8a
Hole Layout (Bottom View) TCS72□2 Series				
TCS72□2 Series	TCS7242-0121177	TCS7252-0121177	TCS7262-0121177	TCS7282-0121177
Contact Arrangement	4	5a	6	8a
Hole Layout (Bottom View) TCS72□6 Series				
TCS72□6 Series	TCS7246-0124177	TCS7266-0124177	TCS7266-0124177	TCS7286-0124177