

## DUAL COMMON CATHODE SCHOTTKY RECTIFIER

### Features

- Low forward voltage drop and leakage current
- Low power loss and High efficiency
- High surge capability
- Dual common cathode rectifier
- Halogen-free device and RoHS compliant device

### Applications

- Power supply - Output rectification
- Converter
- Free-wheeling diode
- Reverse battery protection
- Power inverters

### Description

The SDB10200DI has two schottky barriers arranged in a common cathode configuration. Typical applications are in switching power supplies, converters, free-wheeling diodes, and reverse battery protection.

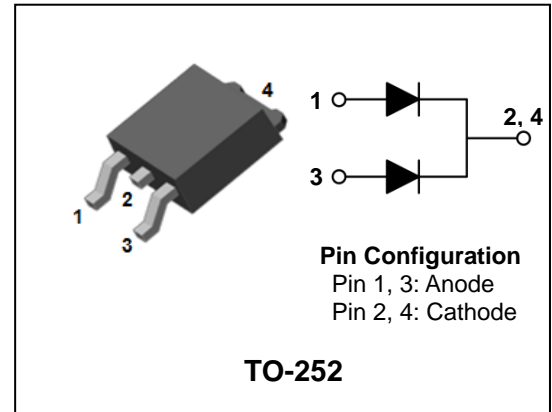

### Product Characteristics

$I_{F(AV)}$	2 X 5A
$V_{RRM}$	200V
$V_{FM}$ at 125°C	0.72V (Typ.)
$I_{FSM}$	120A

### Ordering Information

Device	Marking Code	Package	Packaging
SDB10200DI	SDB10200DI	TO-252	Tape & Reel

### Marking Information

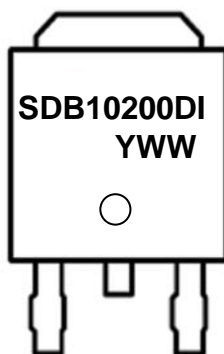

SDB10200DI = Specific Device Code

YWW = Year & Week Code Marking

-. Y = Year Code

-. WW = Week Code

## Absolute Maximum Ratings (Limiting Values)

Characteristic	Symbol	Value	Unit
Maximum repetitive reverse voltage Maximum working peak reverse voltage Maximum DC blocking voltage	$V_{RRM}$ $V_{RWM}$ $V_R$	200	V
Maximum average forward rectified current	per diode	5	A
	total device	10	
Peak forward surge current 8.3ms single half sine-wave superimposed on rated load per diode	$I_{FSM}$	120	A
Storage temperature range	$T_{stg}$	-45°C to +150°C	°C
Maximum operating junction temperature	$T_j$	150	°C

## Thermal Characteristics

Characteristic	Symbol	Value	Unit
Maximum thermal resistance junction to case	per diode	6.0	°C/W
	total device	5.6	

## Electrical Characteristics (Per Diode)

Characteristic	Symbol	Test Condition	Min.	Typ.	Max.	Unit	
Peak forward voltage drop	$V_{FM}^{(1)}$	$I_{FM} = 5A$	$T_j = 25^\circ C$	-	0.85	0.95	V
			$T_j = 125^\circ C$	-	0.72	0.76	V
Reverse leakage current	$I_{RM}^{(1)}$	$V_R = V_{RRM}$	$T_j = 25^\circ C$	-	-	10	uA
			$T_j = 125^\circ C$	-	-	10	mA
Junction capacitance	$C_j$	$V_R = 1V_{DC}, f=1MHz$	-	150	-	pF	

**Note :** (1) Pulse test :  $t_p \leq 380 \mu s$ , Duty cycle  $\leq 2\%$

To evaluate the conduction losses use the following equation:  $P_F = 0.68 I_{F(AV)} + 0.032 I_{F(RMS)}^2$

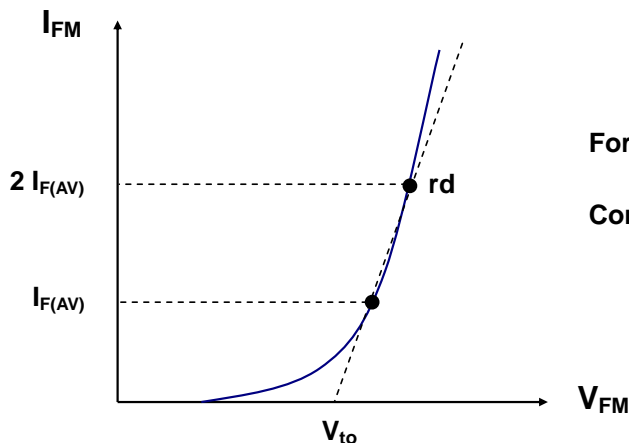

**Forward Voltage :**  $V_{FM} = V_{to} + rd I_{FM}$

**Conduction Loss :**  $P_F = V_{to} I_{F(AV)} + rd I_{F(RMS)}^2$

## Rating and Characteristic Curves

**Fig. 1) Typical Forward Characteristics (Per diode)**

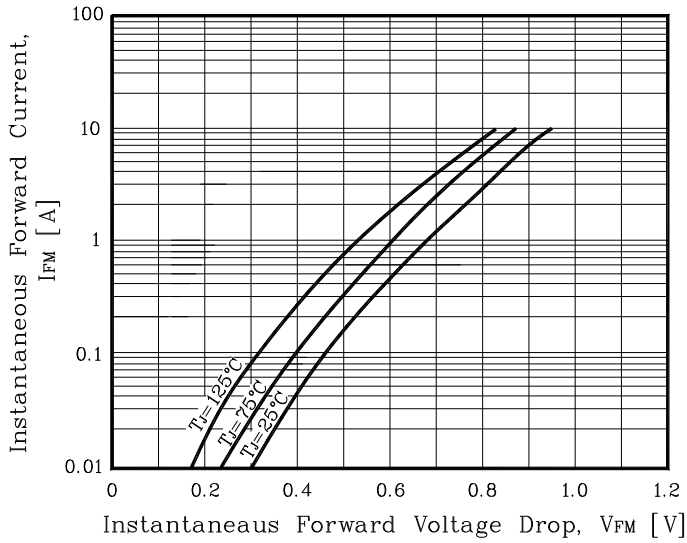

**Fig. 2) Typical Reverse Characteristics (Per diode)**

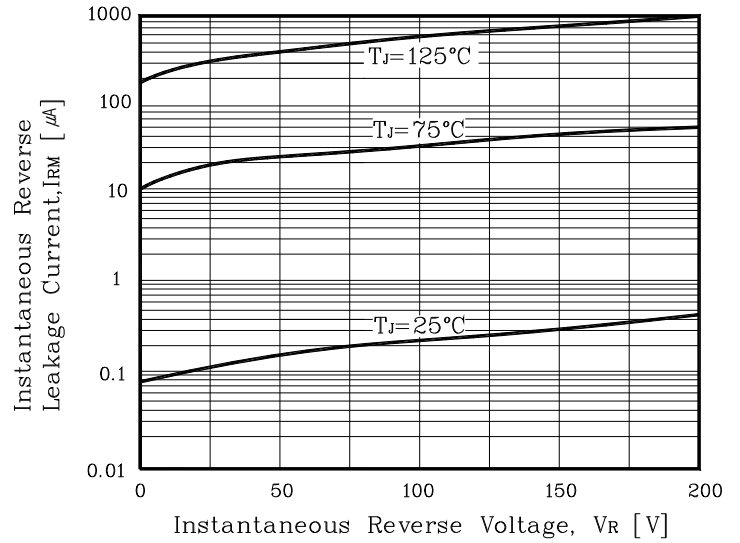

**Fig. 3) Maximum Forward Derivative Curve**

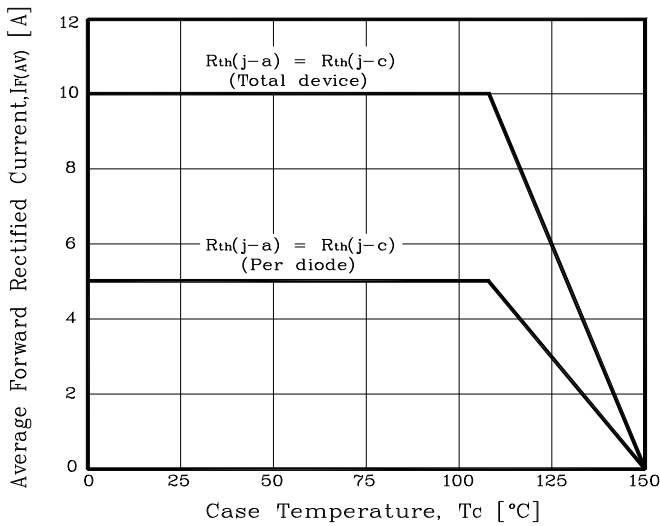

**Fig. 4) Forward Power Dissipation (Per diode)**

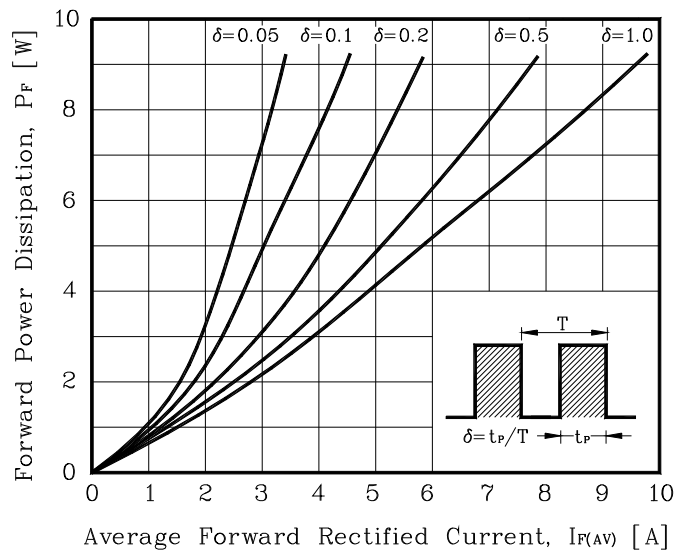

**Fig. 5) Maximum Non-Repetitive Peak Forward Surge Current (Per diode)**

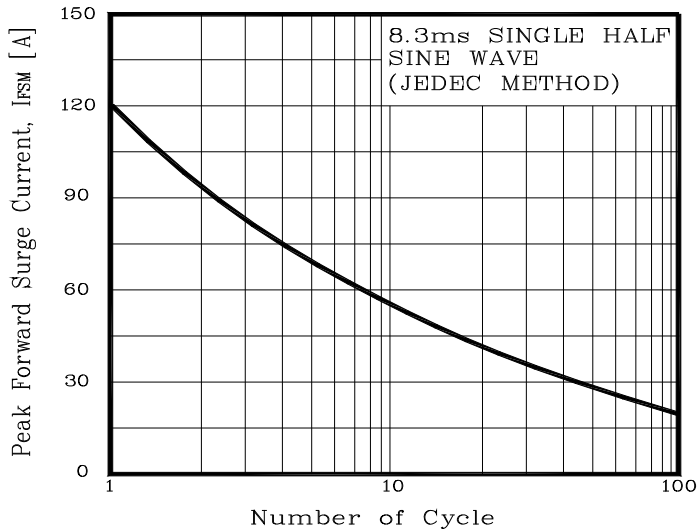

**Fig. 6) Typical Junction Capacitance (Per diode)**

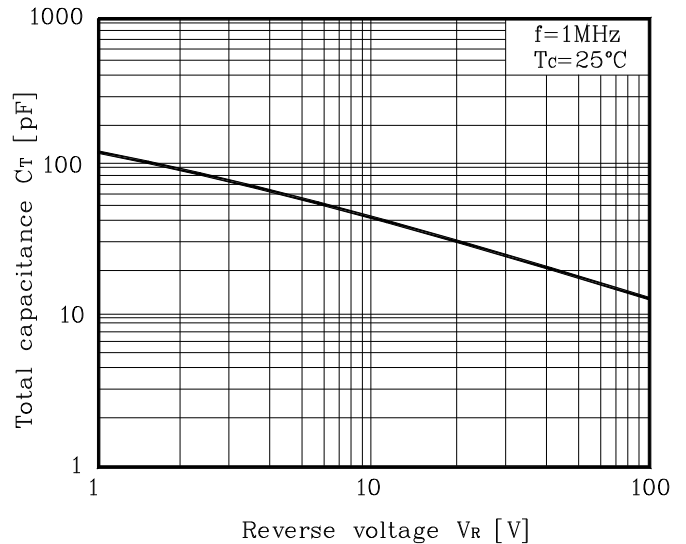

## Package Outline Dimension

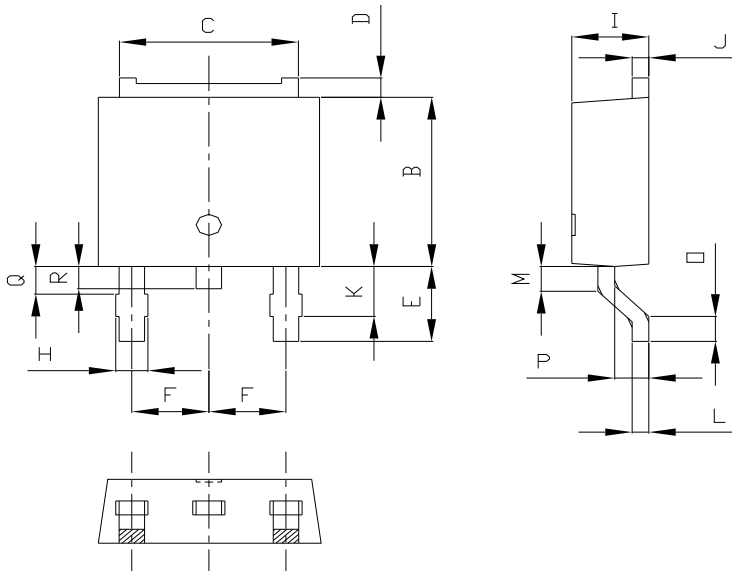

SYMBOL	MILLIMETERS			NOTE
	MINIMUM	NOMINAL	MAXIMUM	
A	6.40	6.60	6.80	
B	5.90	6.10	6.30	
C	5.04	5.34	5.64	
D	0.50	0.70	0.90	
E	2.50	2.70	2.90	
F	2.10	2.30	2.50	
H	0.96 MAX			
I	2.20	2.30	2.40	
J	0.40	0.50	0.60	
K	1.60	1.80	2.00	
L	0.40	0.50	0.60	
M	0.81	0.91	1.01	
O	0.80	0.90	1.00	
P	0.90	1.00	1.10	
Q	0.95 MAX			
R	0.60	0.80	1.00	

### ※ Recommended Land Pattern [unit: mm]

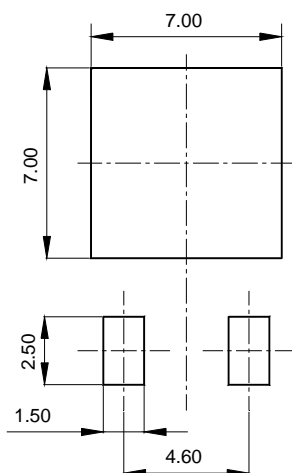

**The AUK Corp. products are intended for the use as components in general electronic equipment (Office and communication equipment, measuring equipment, home appliance, etc.).**

**Please make sure that you consult with us before you use these AUK Corp. products in equipments which require high quality and / or reliability, and in equipments which could have major impact to the welfare of human life(atomic energy control, airplane, spaceship, transportation, combustion control, all types of safety device, etc.). AUK Corp. cannot accept liability to any damage which may occur in case these AUK Corp. products were used in the mentioned equipments without prior consultation with AUK Corp..**

**Specifications mentioned in this publication are subject to change without notice.**