

Li+ Battery Charger with Thermal Regulation

Features

- **Programmable Charge Current Up to 500mA**
- **Charge Status Output Pin**
- **Soft-Start Limits Inrush Current**
- **4.2V Charge Termination Voltage with $\pm 1\%$ Accuracy**
- **45mA Pre-charge Current ($R_{SET}=2K$)**
- **Thermal Regulation Simplifies Board Design**
- **Enable/Disable Control**
- **Available in a SOT-23-5 Package**
- **Lead Free and Green Devices Available (RoHS Compliant)**

Applications

- **Bluetooth Applications**
- **MP3 Players**
- **Cell Phones**
- **Wireless Appliances**

Simplified Application Circuit

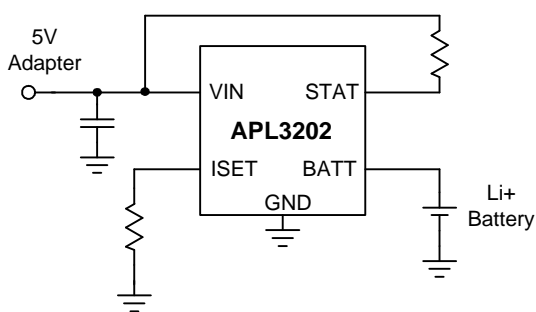

General Description

The APL3202 is a constant-current/constant-voltage linear charger for single cell Li+ batteries. The APL3202 needs no external MOSFETs or diodes, and accepts input voltages up to 6.5V. The small package and low external component counts make the APL3202 an ideal part for portable applications.

On-chip thermal regulation protects the APL3202 from excessive temperature and optimizes the board design for compact size and typical thermal conditions. When the junction temperature reaches the thermal regulation threshold, the charger does not shut down but simply reduces the charge current. Charge current can be programmed by connecting an external resistor from ISET pin to GND. Using an external MOSFET to disconnect the resistor from ground shuts down the charger, and reduces the input supply current down to 25 μ A. The APL3202 also has the STAT pin to indicate charge status. The APL3202 is available in a SOT-23-5 package, and operates over the -40°C to +85°C temperature range.

Pin Configuration

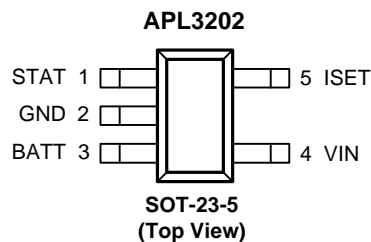

ANPEC reserves the right to make changes to improve reliability or manufacturability without notice, and advise customers to obtain the latest version of relevant information to verify before placing orders.

Ordering and Marking Information

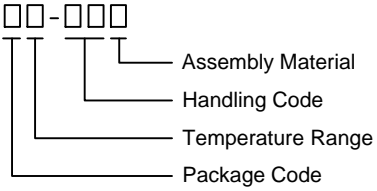
<p>APL3202 □□-□□□</p>  <p> Assembly Material Handling Code Temperature Range Package Code </p>	<p> Package Code B : SOT-23-5 Operating Ambient Temperature Range I : -40 to 85 °C Handling Code TR : Tape & Reel Assembly Material G : Halogen and Lead Free Device </p>
<p>APL3202 B: 302X</p>	<p>X - Date Code</p>

Note: ANPEC lead-free products contain molding compounds/die attach materials and 100% matte tin plate termination finish; which are fully compliant with RoHS. ANPEC lead-free products meet or exceed the lead-free requirements of IPC/JEDEC J-STD-020D for MSL classification at lead-free peak reflow temperature. ANPEC defines "Green" to mean lead-free (RoHS compliant) and halogen free (Br or Cl does not exceed 900ppm by weight in homogeneous material and total of Br and Cl does not exceed 1500ppm by weight).

Absolute Maximum Ratings (Note 1)

Symbol	Parameter	Rating	Unit
V_{IN}	VIN to GND	-0.3 to 7	V
$V_{SET}, V_{STAT}, V_{BATT}$	ISET, STAT, BATT to GND	-0.3 to 7	V
I_{CHG}	Charge Current	0.8	A
T_J	Maximum Junction Temperature	150	°C
T_{STG}	Storage Temperature Range	-65 to 150	°C
T_{SDR}	Maximum Lead Soldering Temperature, 10 Seconds	260	°C

Note1: Stresses beyond those listed under "absolute maximum ratings" may cause permanent damage to the device. These are stress ratings only and functional operation of the device at these or any other conditions beyond those indicated under "recommended operating conditions" is not implied. Exposure to absolute maximum rating conditions for extended periods may affect device reliability.

Thermal Characteristics

Symbol	Parameter	Typical Value	Unit
θ_{JA}	Junction to Ambient Resistance ^(Note 2) SOT-23-5	125	°C/W

Note 2: θ_{JA} is measured with the component mounted on a high effective thermal conductivity test board in free air.

Recommended Operating Conditions (Note 3)

Symbol	Parameter	Range	Unit
V_{IN}	VIN to GND	4.35 to 6.5	V
I_{CHG}	Charge Current	0.1 to 0.5	A
T_J	Junction Temperature	-40 to 125	°C
T_A	Ambient Temperature	-40 to 85	°C

Note 3 : Refer to the typical application circuit.

Electrical Characteristics

Refer to the typical application circuit. These specifications apply over $V_{IN}=5V$, $T_A = -40\sim 85^\circ C$, unless otherwise specified. Typical values are at $T_A=25^\circ C$.

Symbol	Parameter	Test Conditions	APL3202			Unit
			Min.	Typ.	Max.	
SUPPLY CURRENT						
I_{IN}	VIN Supply Current ^(Note 4)	Charge mode, $R_{SET}=10K$	-	300	600	μA
		Standby mode (Charge terminated)	-	200	500	
		Shutdown mode (R_{SET} not connected, $V_{IN}<V_{BATT}$, or $V_{IN}<V_{UVLO}$)	-	25	50	
BATT REVERSE CURRENT						
I_{BATT}	BATT Standby Input Current	Standby mode, $V_{BATT}=4.2V$	0	2.5	6	μA
	BATT Shutdown Input Current	Shutdown mode (R_{SET} not connected)	-	-	1	
	BATT Sleep Input Current	Sleep mode, $V_{IN}=0V$	-	-	1	
UNDER-VOLTAGE LOCKOUT						
V_{UVLO}	VIN UVLO Threshold	V_{IN} rising	3.75	3.85	3.95	V
	VIN UVLO Hysteresis		0.15	0.20	0.30	V
BATTERY VOLTAGE AND THRESHOLD VOLTAGE						
V_{TERM}	BATT Charge Termination Voltage		-	4.20	-	V
	BATT Charge Termination Voltage Accuracy	$T_A=25^\circ C$, $V_{IN}=4.35\sim 6.5V$	-0.5	-	0.5	%
		$T_A = -40\sim 85^\circ C$	-1	-	1	%
	BATT Pre-charge Threshold Voltage	V_{BATT} rising	2.8	2.9	3.0	V
	BATT Pre-charge Hysteresis Voltage		60	80	110	mV
V_{ASD}	$V_{IN}-V_{BATT}$ Lockout Threshold Voltage	V_{IN} from low to high	80	120	160	mV
		V_{IN} from high to low	40	80	120	
V_{RECHRG}	Recharge Threshold Voltage		3.9	4.05	4.2	V
V_{MSD}	Manual Shutdown Threshold Voltage	V_{SET} rising	1.15	1.21	1.3	V
		V_{SET} falling	0.9	1.0	1.1	
BATTERY CHARGING AND PRE-CHARGE CURRENT						
I_{CHG}	Charging Current	$R_{SET}=10K$ Without thermal regulation	91	100	109	mA
		$R_{SET}=2K$ Without thermal regulation	455	500	545	
V_{SET}	ISET Regulation Voltage	Without thermal regulation	-	1	-	V
	ISET Regulation Voltage Accuracy	$T_J=-40\sim 125^\circ C$, $V_{IN}=4.35\sim 6.5V$	-0.7	-	0.7	%
	ISET Pull-Up Current	$V_{SET}=1V$, $T_A=25^\circ C$	-	2.5	-	μA
K_{SET}	Charging Current Set Factor	$0.1A \leq I_{CHG} \leq 0.5A$	940	1000	1060	-
	Pre-charging Current	$V_{BATT}<2.8V$, $R_{SET}=2K$	20	45	70	mA
I_{TERM}	C/10 Termination Current Threshold	$R_{SET}=2K$ to $10K$	8.5	10	11.5	%
DROPOUT VOLTAGE						
	Power FET On Resistance		-	800	1200	m Ω
	V_{IN} to V_{BATT} Dropout Voltage	$I_{CHG}=0.5A$, $V_{IN}=5V$	-	400	600	mV

Electrical Characteristics (Cont.)

Refer to the typical application circuit. These specifications apply over $V_{IN}=5V$, $T_A = -40\sim 85^{\circ}C$, unless otherwise specified. Typical values are at $T_A=25^{\circ}C$.

Symbol	Parameter	Test Conditions	APL3202			Unit
			Min.	Typ.	Max.	
STAT PIN AND THERMAL REGULATION						
V_{STAT}	STAT Output Low Voltage	$I_{STAT} = 5mA$	-	0.35	0.6	V
	STAT Off-leakage Current	$V_{STAT}=5V$	-	-	1	μA
T_{LIM}	Thermal Regulation Threshold		-	120	-	$^{\circ}C$
SOFT-START AND TIMING						
T_{SS}	Soft-Start Interval	$I_{CHG}=0A$ to full charging current $T_A=25^{\circ}C$	-	100	-	μs
$T_{RECHARGE}$	Recharge Comparator Filter Time	V_{BATT} high to low, $T_A=25^{\circ}C$	0.75	2	4.5	ms
T_{TERM}	Termination Comparator Filter Time	I_{CHG} falling below I_{TERM} , $T_A=25^{\circ}C$	0.4	1	2.5	ms

Note 4 : Supply current includes ISET pin current but does not include any current delivered to the battery through the BATT pin.

Typical Operating Characteristics

Refer to the typical application circuit, $V_{IN}=5V$, $T_A = 25^{\circ}C$, unless otherwise specified.

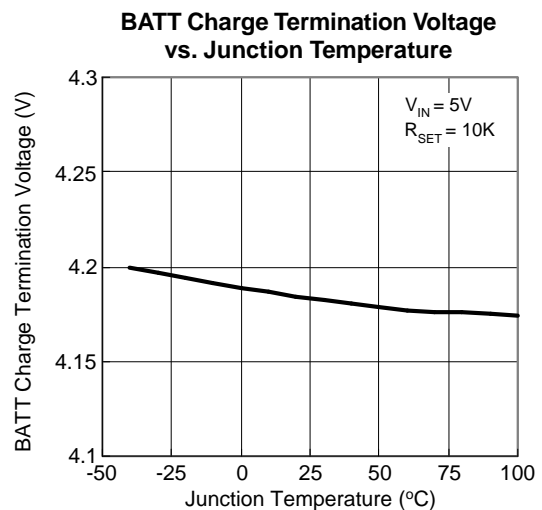
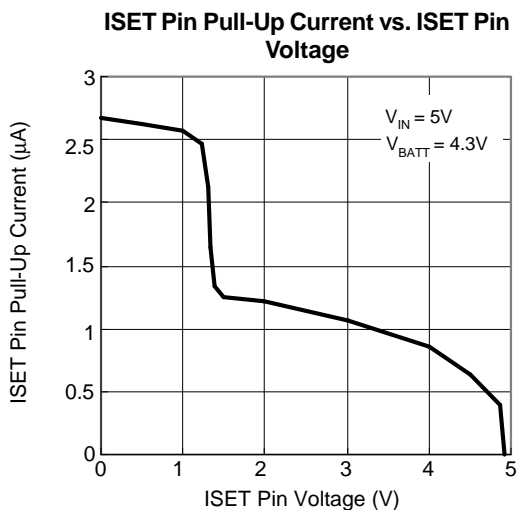
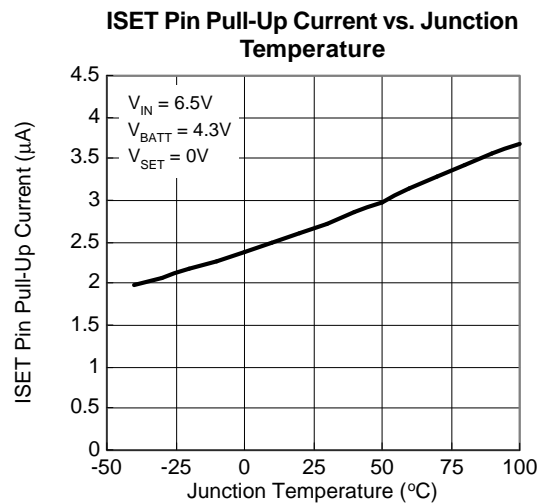
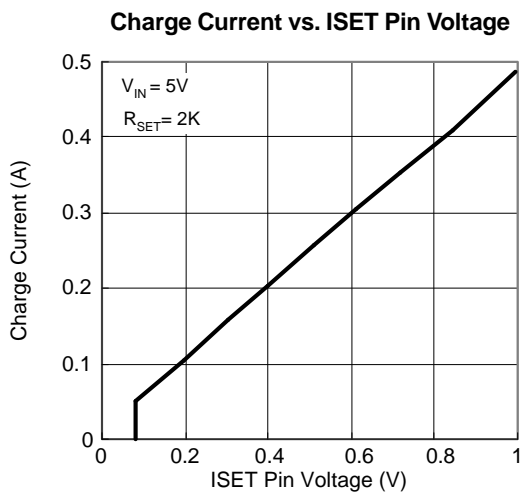
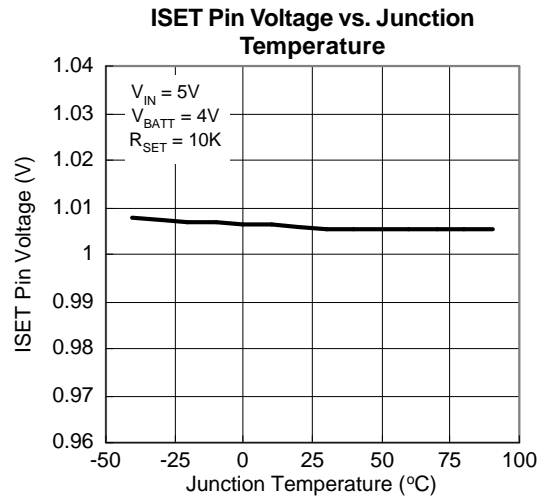
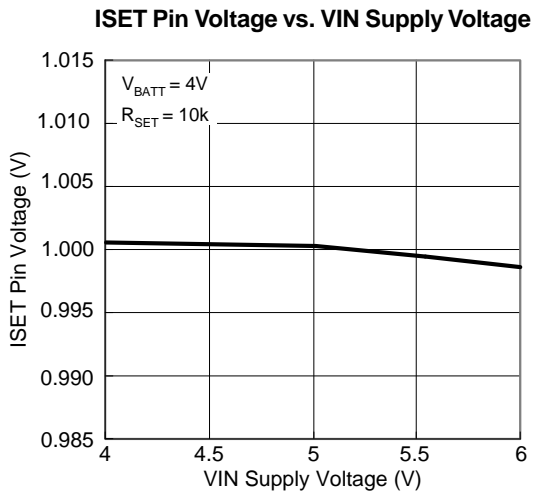

Typical Operating Characteristics (Cont.)

Refer to the typical application circuit, $V_{IN}=5V$, $T_A = 25^\circ C$, unless otherwise specified.

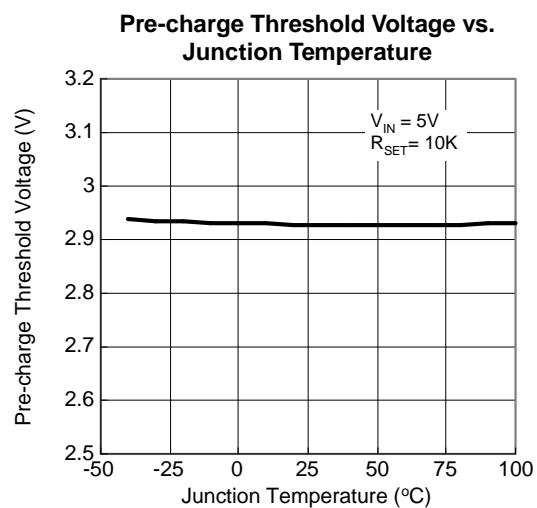
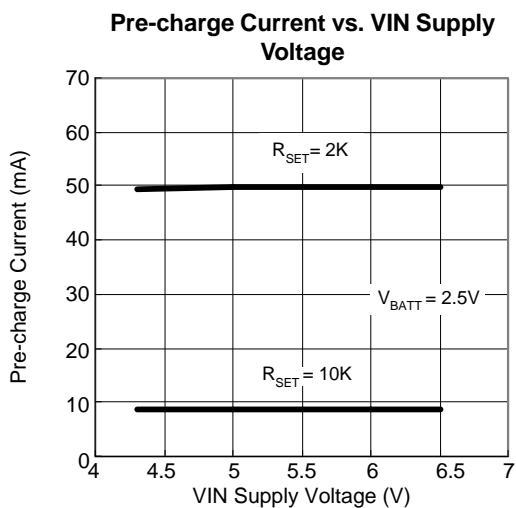
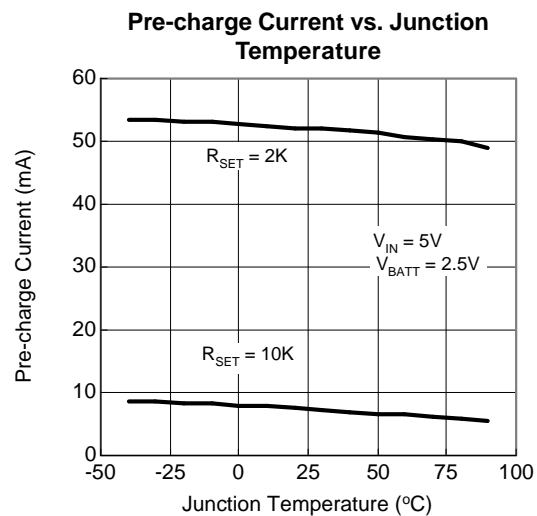
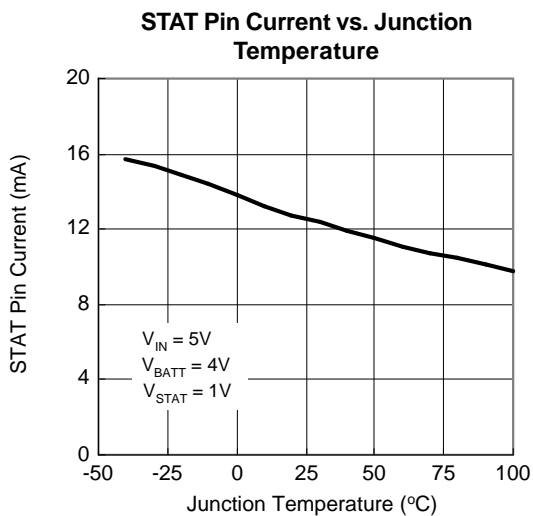
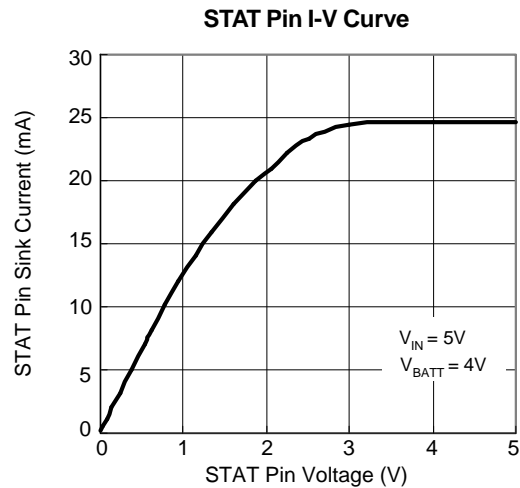
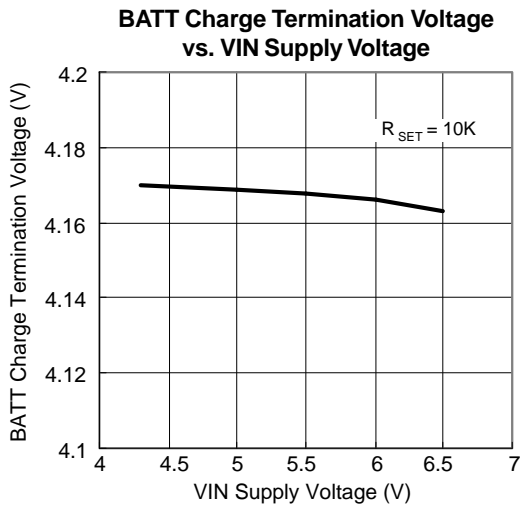

Typical Operating Characteristics (Cont.)

Refer to the typical application circuit, $V_{IN}=5V$, $T_A=25^\circ C$, unless otherwise specified.

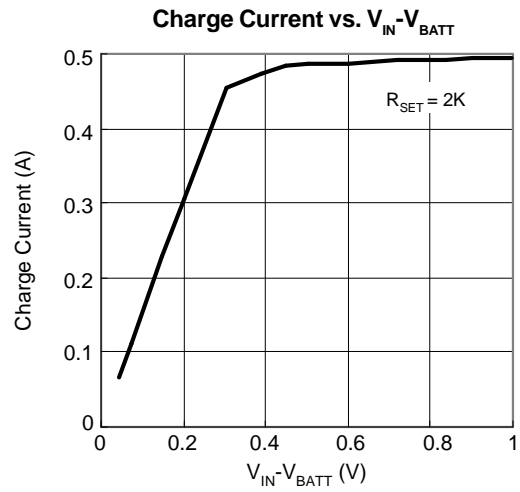
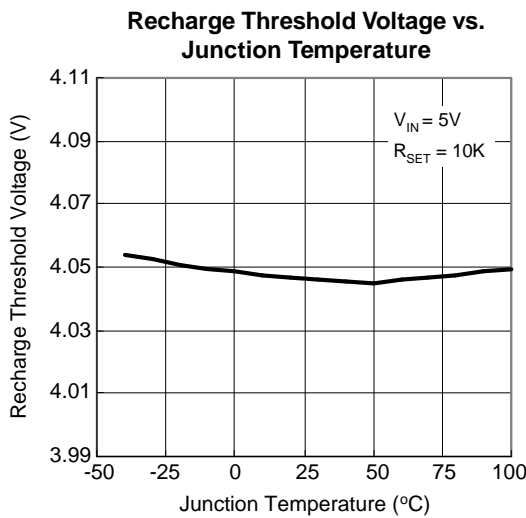
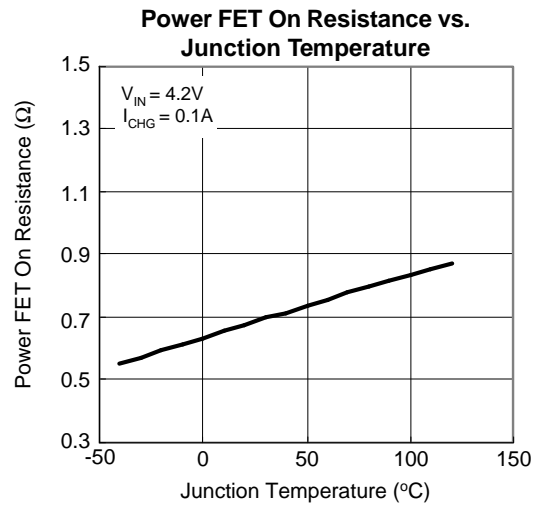
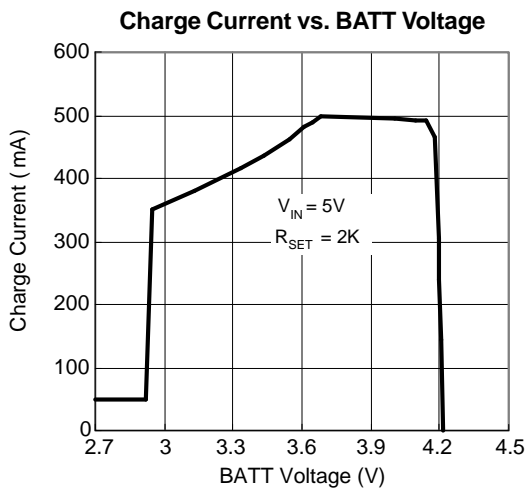

Operating Waveforms

Refer to the typical application circuit, $V_{IN}=5V$, $T_A=25^{\circ}C$, unless otherwise specified.

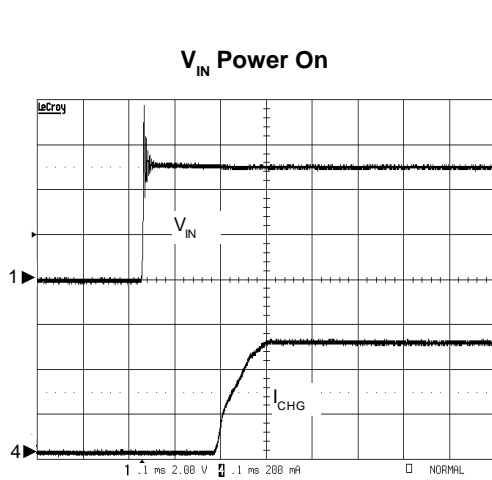

$R_{SET} = 2K$, $V_{BATT}=3.8V$
 CH1: V_{IN} , 2V/div, DC
 CH4: I_{CHG} , 0.2A/div, DC
 TIME: 0.1ms/div

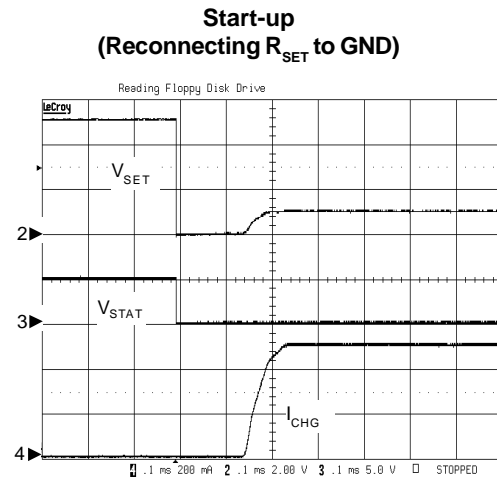

$R_{SET} = 2K$, $V_{BATT}=3.8V$
 CH2: V_{SET} , 2V/div, DC
 CH3: V_{STAT} , 5V/div, DC
 CH4: I_{CHG} , 0.2A/div, DC
 TIME: 0.1ms/div

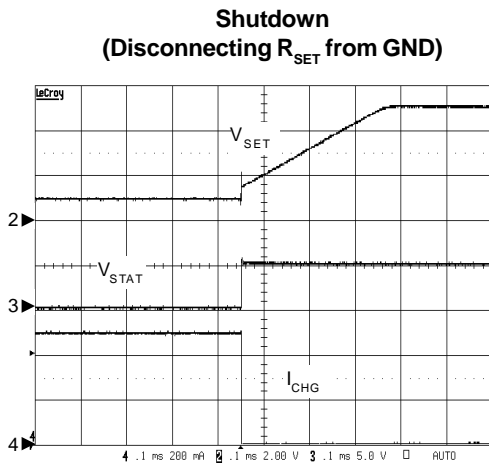

$R_{SET} = 2K$, $V_{BATT}=3.8V$
 CH2: V_{SET} , 2V/div, DC
 CH3: V_{STAT} , 5V/div, DC
 CH4: I_{CHG} , 0.2A/div, DC
 TIME: 0.1ms/div

Pin Description

PIN		FUNCTION
NO.	NAME	
1	STAT	Open-Drain Charge Status Output Pin. When the battery is charging, the STAT pin is pulled low by an internal switch. In other states the STAT pin is in a high impedance state.
2	GND	Ground.
3	BATT	Charger Output Pin. Connect this pin to the positive terminal of a Li+ battery.
4	VIN	Input Supply Pin. Provides power to the charger, V_{IN} can range from 4.35V to 6.5V and should be bypassed with a 4.7 μ F capacitor.
5	ISET	Charging Current Setting and Shutdown Pin. Connecting a resistor from this pin to GND to set the charge current. Disconnecting the R_{SET} from GND allows an internal 2.5 μ A current to pull the ISET pin high, and when the ISET pin voltage exceeds the shutdown threshold voltage, the IC enters shutdown mode.

Block Diagram

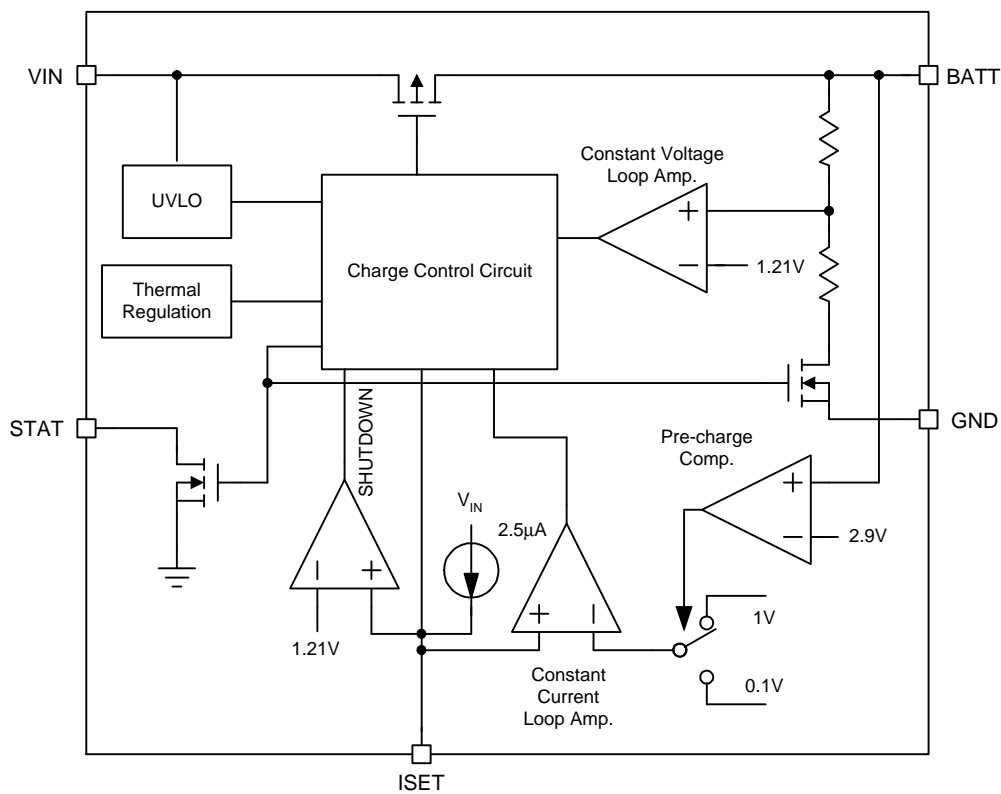

Typical Application Circuit

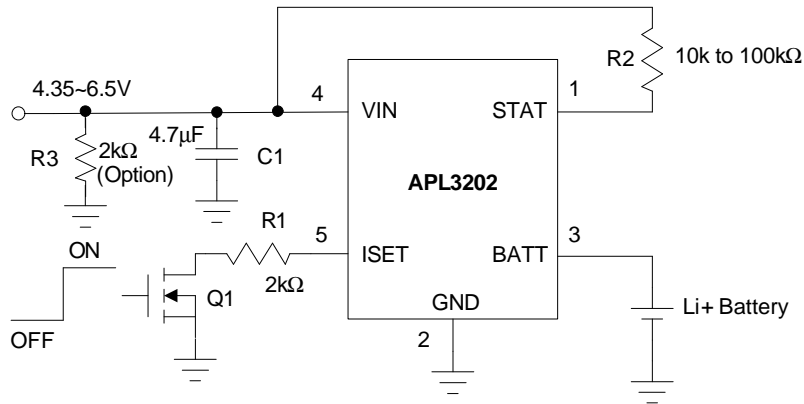

Designation	Description
C1	4.7μF, 10V, X5R, 0805 Murata GRM188R61A475K
Q1	SOT-23, N-Channel MOSFET ANPEC APM2300CA

Murata website: www.murata.com

Function Description

Charge Cycle

When the APL3202 is powered with a battery connected, the IC firstly detects if the cell voltage is ready for full charge current. If the battery voltage is below pre-charge threshold (2.9V typ.), the device supplies 1/10 the programmed charge current. On the contrary, when the battery voltage is over the pre-charge threshold, the device supplies the full charge current, as programmed by R_{SET} from ISET pin to GND. When the battery voltage approaches the 4.2V termination voltage, the device enters constant-voltage mode and the full charge current gradually decreases until the charge current drops to the termination current threshold, which is equal to 1/10 full charging current, and the IC stops charging (see Figure 1).

Full Charge Current Setting

The full charge current is programmed by connecting a resistor from the ISET pin to ground. The full charge current is 1000 times of the current flowing out of the ISET pin and can be calculated by the following equation:

$$I_{CHG} = \frac{K_{SET} \times V_{SET}}{R_{SET}}$$

where

V_{SET} is ISET regulation voltage (1V, typical).

K_{SET} is the charging current set factor (1000, typical).

The charging current set factor and the ISET regulation voltage are shown in the Electrical Characteristics. The ISET regulation voltage is reduced by thermal regulation function.

Charge Termination Detection and Recharge

Charging is terminated when I_{CHG} falls to 10% of the full charge current set by R_{SET} and the charger is in voltage mode (V_{BATT} is nearly 4.2V). The charge termination is detected by monitoring the ISET pin. When the ISET pin voltage falls below 0.1V and takes longer than T_{TERM} (1ms, typical), charging is terminated. The STAT output keeps high state when the charger operates in standby mode. After charge termination, the battery voltage is monitored by the APL3202 continuously. If the battery voltage drops below 4.05V and takes longer than $T_{RECHARGE}$ (2ms, typical), a new charge cycle starts to recharge the battery.

Manual Shutdown

The ISET pin provides two functions: connecting the resistor R_{SET} from the ISET pin to ground to set the full charge current; and disconnecting the R_{SET} from GND to shut down the device. Once the R_{SET} is disconnected, an internal 2.5 μ A current pulls the ISET pin high. When the ISET pin voltage reaches the 1.21V shutdown threshold voltage, the device enters shutdown mode. In shutdown mode, the charging stops, the VIN supply current drops to 25 μ A and the battery drain current is below 1 μ A. Re-connecting R_{SET} to ground enables the charger to operation normally. The STAT output keeps high state when the charger is turned to shutdown mode.

Thermal Regulation

The APL3202 is thermally regulated to keep the junction temperature at 120°C. When the junction temperature reaches 120°C, the charger does not shut down but reduces charge current to keep the junction temperature at 120°C. This feature protects the APL3202 from excessive temperature and allows the charger to operate with maximum power dissipation by reducing the charge current and optimizes the board design for compact size and typical thermal conditions.

Charge Status Output (STAT)

The STAT is an open-drain output. When the charger is in charge mode, the STAT output is in pull-low state. Until the charge current drops to the termination current threshold, the charging stops, and the STAT output is in high impedance state.

Function Description (Cont.)

Charge Status Output (STAT) (Cont.)

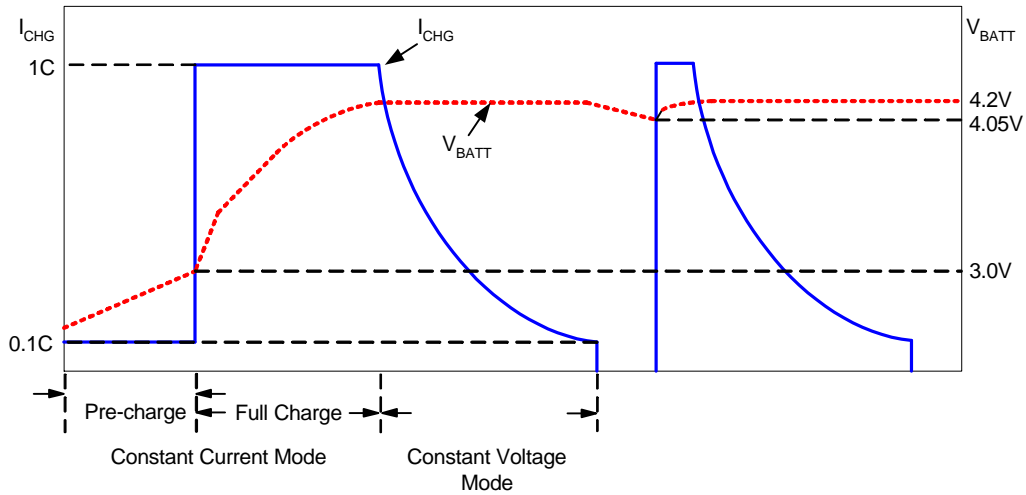

Figure1. Typical Charging Profile

STAT Output	Mode	V _{IN}	V _{BATT}	V _{SET}
Low	Charge Mode	V _{IN} >V _{UVLO} & V _{IN} >V _{BATT} +V _{ASD}	V _{BATT} <4.2V	0.1V<V _{SET} <1.2V
High	Shutdown Mode	V _{IN} >V _{UVLO} & V _{IN} >V _{BATT} +V _{ASD}	-	V _{SET} >1.2V
	Standby Mode	V _{IN} >V _{UVLO} & V _{IN} >V _{BATT} +V _{ASD}	V _{BATT} >4.2V	-
	Sleep Mode	V _{IN} <V _{UVLO} or V _{IN} <V _{BATT} +V _{ASD}	Battery is connected	-

Table1. STAT Pin Summary

Application Information

Input and Output Capacitors

Typically, a 4.7μF ceramic capacitor is used to connect from VIN to GND. Place the capacitor as close as possible to the VIN pin and GND pin for well operation. In some start-up conditions, it maybe necessary to protect the device against a hot plug input voltage. Adding a 6V input zener diode between the VIN pin and GND clamps the input voltage peak. In most applications, it is also recommended to connect an X5R ceramic capacitor (1μF, typical) from BATT to GND for proper stability.

STAT Pin

The STAT pin can be used to drive a LED or communicate with the host processor to show the charge status. When the status is displayed by a LED, which has a current rating less than 5mA, a resistor should be selected to connect the LED in series, for programming at the desired current value. The resistor is calculated by the following equation:

$$R_{LED} = \frac{(V_{IN} - V_{LED-ON})}{I_{LED}}$$

When STAT pin is monitored by a processor, there should be a 10kΩ to 100kΩ pull-up resistor to connect the STAT pin and the supply voltage of the processor.

Thermal Consideration

The most common measure of package thermal performance is thermal resistance measured from the device junction to the air surrounding the package surface (θ_{JA}). The θ_{JA} can be calculated by the following equation:

$$\theta_{JA} = \frac{T_J - T_A}{P_D}$$

where:

T_J = device junction temperature, maximum $T_J=120^\circ\text{C}$

T_A = ambient temperature

P_D = device power dissipation

The device power dissipation, P_D , is a function of the charge rate and the voltage drop across the internal FET.

It can be calculated by the following equation:

$$P_D = (V_{IN} - V_{BATT}) \times I_{CHG}$$

PCB Layout Consideration

Connect the battery to BATT as close as possible to provide accurate battery voltage sensing. The input and output decoupling capacitors and the programmed resistor R_{SET} should be placed as close as possible to the device. The high-current charge paths into VIN and from the BATT pins must be short and wide to minimize voltage drops.

Recommended Minimum Footprint

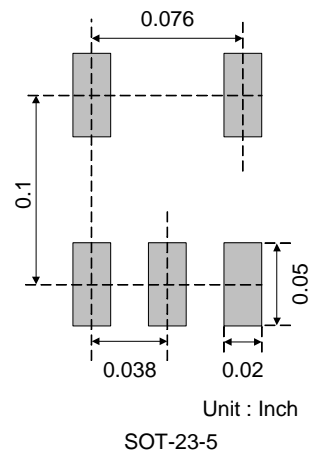

Package Information

SOT-23-5

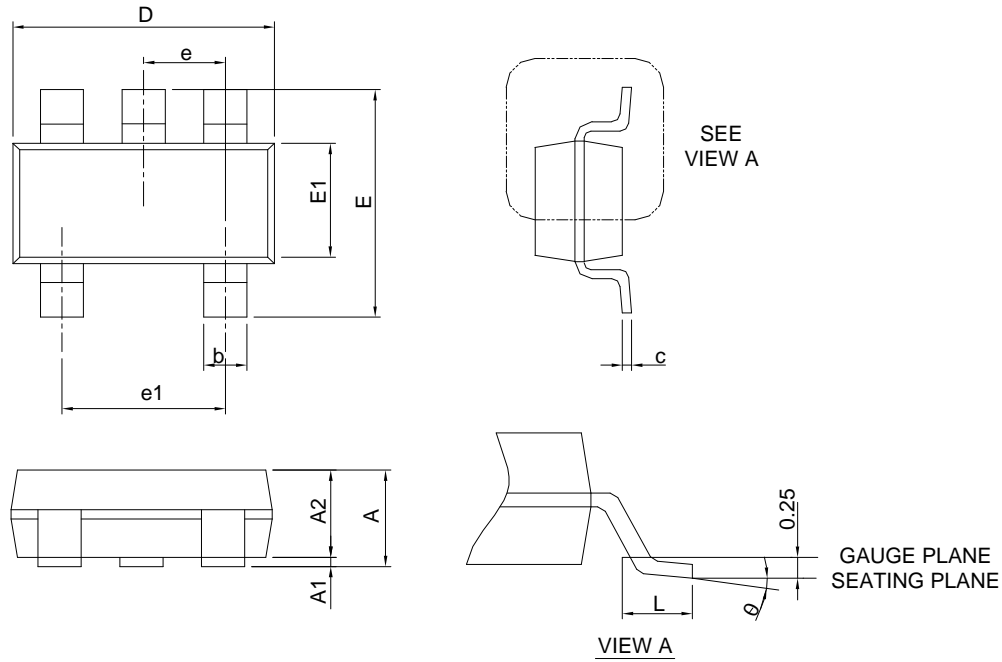

SYMBOL	SOT-23-5			
	MILLIMETERS		INCHES	
	MIN.	MAX.	MIN.	MAX.
A		1.45		0.057
A1	0.00	0.15	0.000	0.006
A2	0.90	1.30	0.035	0.051
b	0.30	0.50	0.012	0.020
c	0.08	0.22	0.003	0.009
D	2.70	3.10	0.106	0.122
E	2.60	3.00	0.102	0.118
E1	1.40	1.80	0.055	0.071
e	0.95 BSC		0.037 BSC	
e1	1.90 BSC		0.075 BSC	
L	0.30	0.60	0.012	0.024
θ	0°	8°	0°	8°

Note : 1. Follow JEDEC TO-178 AA.
 2. Dimension D and E1 do not include mold flash, protrusions or gate burrs. Mold flash, protrusion or gate burrs shall not exceed 10 mil per side.

Carrier Tape & Reel Dimensions

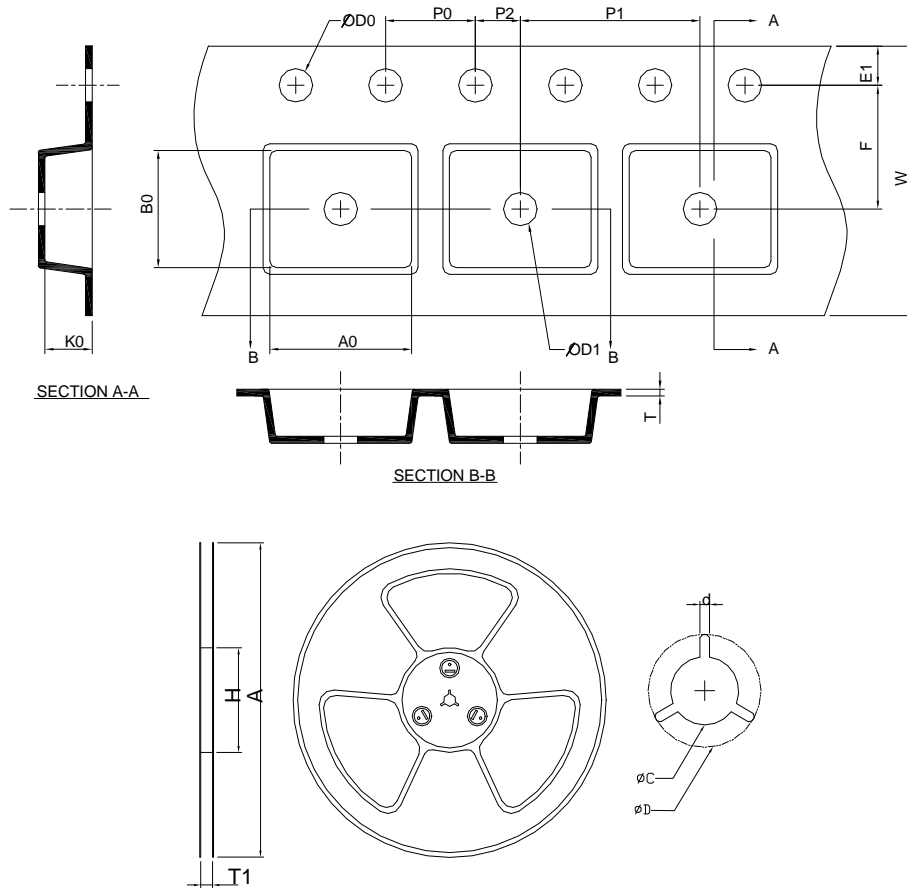

Application	A	H	T1	C	d	D	W	E1	F
SOT-23-5	178.0 ± 2.00	50 MIN.	8.4+2.00 -0.00	13.0+0.50 -0.20	1.5 MIN.	20.2 MIN.	8.0 ± 0.30	1.75 ± 0.10	3.5 ± 0.05
	P0	P1	P2	D0	D1	T	A0	B0	K0
	4.0 ± 0.10	4.0 ± 0.10	2.0 ± 0.05	1.5+0.10 -0.00	1.0 MIN.	0.6+0.00 -0.40	3.20 ± 0.20	3.10 ± 0.20	1.50 ± 0.20

(mm)

Devices Per Unit

Package Type	Unit	Quantity
SOT-23-5	Tape & Reel	3000

Taping Direction Information

SOT-23-5

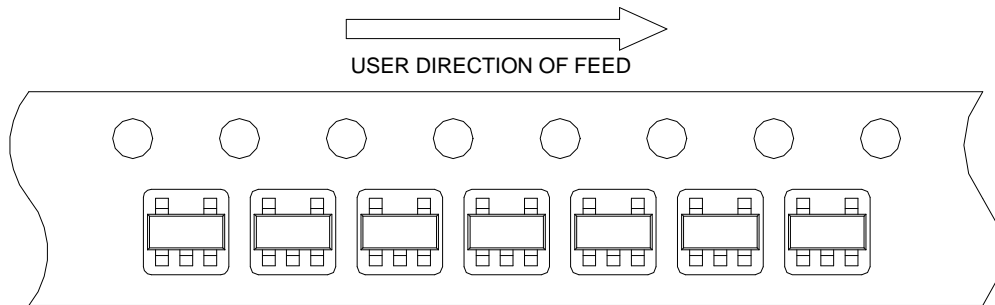

Classification Profile

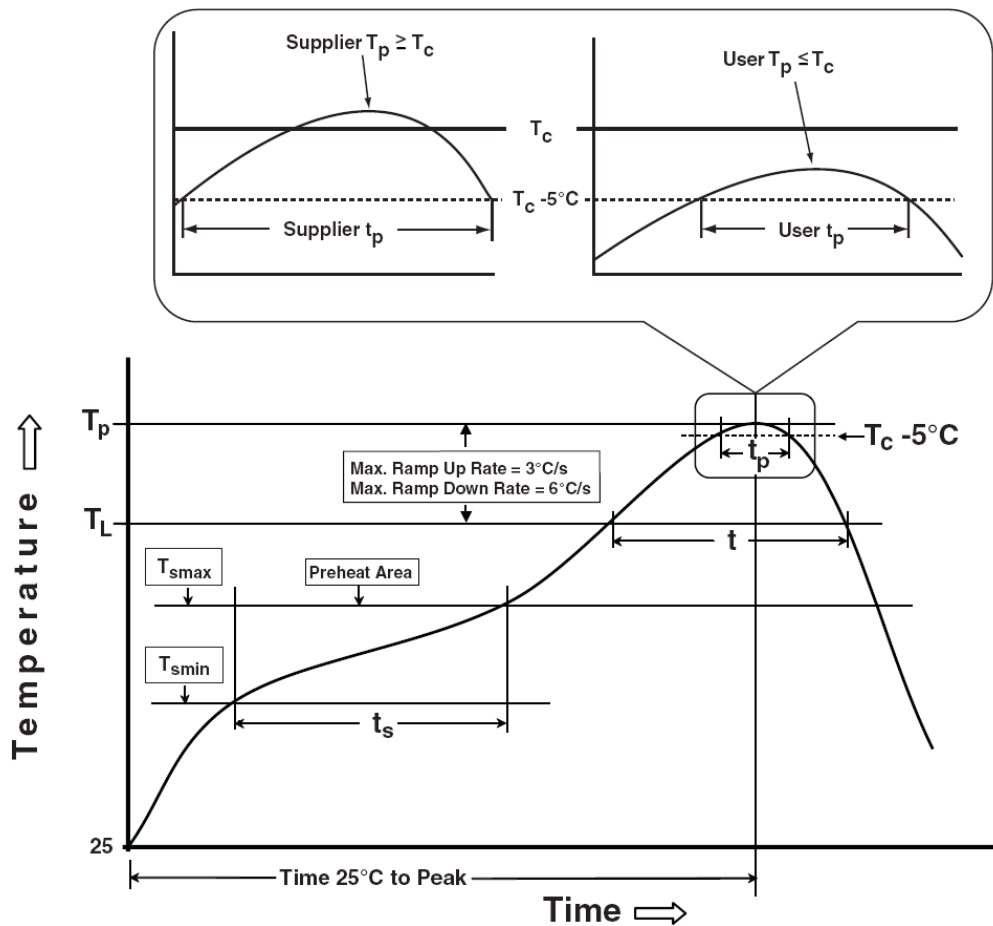

Classification Reflow Profiles

Profile Feature	Sn-Pb Eutectic Assembly	Pb-Free Assembly
Preheat & Soak		
Temperature min (T_{smin})	100 °C	150 °C
Temperature max (T_{smax})	150 °C	200 °C
Time (T_{smin} to T_{smax}) (t_s)	60-120 seconds	60-120 seconds
Average ramp-up rate (T_{smax} to T_p)	3 °C/second max.	3°C/second max.
Liquidous temperature (T_L)	183 °C	217 °C
Time at liquidous (t_L)	60-150 seconds	60-150 seconds
Peak package body Temperature (T_p)*	See Classification Temp in table 1	See Classification Temp in table 2
Time (t_p)** within 5°C of the specified classification temperature (T_c)	20** seconds	30** seconds
Average ramp-down rate (T_p to T_{smax})	6 °C/second max.	6 °C/second max.
Time 25°C to peak temperature	6 minutes max.	8 minutes max.
* Tolerance for peak profile Temperature (T_p) is defined as a supplier minimum and a user maximum.		
** Tolerance for time at peak profile temperature (t_p) is defined as a supplier minimum and a user maximum.		

Table 1. SnPb Eutectic Process – Classification Temperatures (T_c)

Package Thickness	Volume mm ³	Volume mm ³
	<350	≥350
<2.5 mm	235 °C	220 °C
≥2.5 mm	220 °C	220 °C

Table 2. Pb-free Process – Classification Temperatures (T_c)

Package Thickness	Volume mm ³	Volume mm ³	Volume mm ³
	<350	350-2000	>2000
<1.6 mm	260 °C	260 °C	260 °C
1.6 mm – 2.5 mm	260 °C	250 °C	245 °C
≥2.5 mm	250 °C	245 °C	245 °C

Reliability Test Program

Test item	Method	Description
SOLDERABILITY	JESD-22, B102	5 Sec, 245°C
HOLT	JESD-22, A108	1000 Hrs, Bias @ $T_j=125^\circ\text{C}$
PCT	JESD-22, A102	168 Hrs, 100%RH, 2atm, 121°C
TCT	JESD-22, A104	500 Cycles, -65°C~150°C
HBM	MIL-STD-883-3015.7	VHBM 2KV
MM	JESD-22, A115	VMM 200V
Latch-Up	JESD 78	10ms, 1_{tr} 100mA

Customer Service

Anpec Electronics Corp.

Head Office :

No.6, Dusing 1st Road, SBIP,
Hsin-Chu, Taiwan, R.O.C.
Tel : 886-3-5642000
Fax : 886-3-5642050

Taipei Branch :

2F, No. 11, Lane 218, Sec 2 Jhongsing Rd.,
Sindian City, Taipei County 23146, Taiwan
Tel : 886-2-2910-3838
Fax : 886-2-2917-3838