

# INTERNATIONAL RECTIFIER

## 1N3288, 1N3288A SERIES 100 Amp Avg Silicon Rectifier Diodes

### Major Ratings and Characteristics

	1N3288	1N3288A	Units
$I_{F(AV)}$	100*	100*	A
@ Max. $T_C$	130	130	$^{\circ}C$
$I_{FSM}$ @ 50 Hz	1550	2200	A
	@ 60 Hz	1600*	
$I^2t$ @ 50 Hz	11,500	24,000	$A^2s$
	@ 60 Hz	10,500	
$I^2\sqrt{t}$	165,000	340,000	$A^2\sqrt{s}$
$V_{RRM}$ Range	100 -1200	100 -1200	V

\*JEDEC registered values.

### Description and Features

- Reverse voltage ratings up to 1200 volts
- High surge rating series (2,300A)
- DO-8 hermetically sealed package
- Superior reliability under extreme conditions
- Can be supplied to meet stringent military, aerospace and other high-reliability requirements

### CASE STYLE AND DIMENSIONS

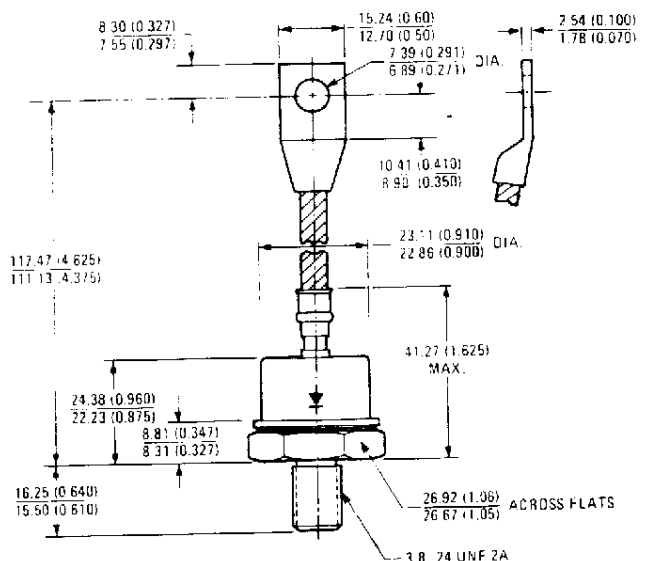
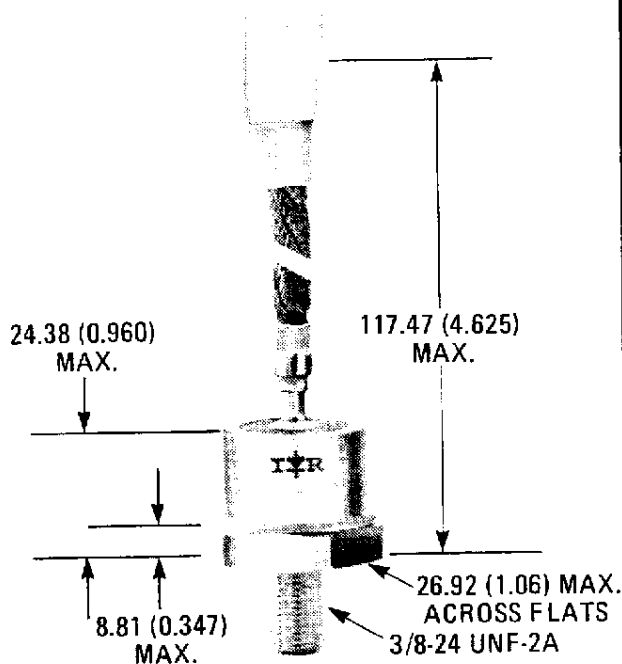

Conforms to JEDEC outline DO-205AA (DO-8) (IR B-15)

All Dimensions in Millimeters and (Inches)

VOLTAGE RATINGS

	VRRM – Max. Repetitive Peak Reverse Voltage (V)	VRSM – Max. Non-repetitive Peak Reverse Voltage (V)	VR – Max. Direct Reverse Voltage (V)	IRRM – Max. Peak Reverse Current Max. Rated IF(AV) and VRRM 1 Phase Operation (mA)
Part Number ①	TC = -40°C to 200°C ②	TC = 25°C to 200°C	TC = -40°C to 200°C ②	TC = 130°C
1N3288 1N3288A	100*	200*	100*	24*
1N3289 1N3289A	200*	300*	200*	24*
1N3290 1N3290A	300*	400*	300*	24*
1N3291 1N3291A	400*	525*	400*	24*
1N3292 1N3292B	500*	650*	500*	21*
1N3293 1N3293A	600*	800*	600*	17*
1N3294 1N3294A	800*	1050*	800*	13*
1N3295 1N3295A	1000*	1300*	1000*	11*
1N3296 1N3296A	1200*	1600*	1200*	9*

① Basic number indicates cathode-to-case. For anode-to-case, add "R" to part number, e.g., 1N3291RA

ELECTRICAL SPECIFICATIONS

	1N3288	1N3288A ③	Units	Conditions
IF(AV) Max. average forward current	100*	100*	A	180° sinusoidal conduction. Max. TC = 130°C*
IFSM Max. peak one-cycle non-repetitive surge current	1550	2200	A	Half cycle 50 Hz sine wave or 6 ms rectangular pulse Following any rated load condition and with rated VRRM applied.
	1600	2300		
	1800	2600		Half cycle 50 Hz sine wave or 6 ms rectangular pulse Following any rated load condition and with VRRM applied following surge = 0.
	1900	2750		
I2t Max. I2t for fusing	11,500	24,000	A2s	t = 10 ms With rated VRRM applied following surge, initial TJ = 200°C
	10,500	22,000		t = 8.3 ms
	16,500	34,000		t = 10 ms With VRRM = 0 following surge, initial TJ = 200°C
				t = 8.3 ms
I2√t Max. I2√t for individual device ④	165,000	340,000	A2√s	t = 0.1 to 10 ms, VRRM = 0 following surge.
VFM Max. peak forward voltage	1.5*	1.5*	V	IF(AV) = 100A (314A peak), TC = 130°C

THERMAL-MECHANICAL SPECIFICATIONS

TC Max. operating case temperature range	-40° to 200° ②	°C	1N3292B: -65° to 200°C
Tstg Max. storage temperature range	-40° to 200° ①	°C	1N3292B: -65° to 200°C
RthJC Max. internal thermal resistance, junction-to-case	0.4*	deg C/W	DC operation.
RthCS Thermal resistance, case-to-sink	0.1	deg C/W	Mounting surface flat, smooth, and greased.
T Mounting torque	11.3-14.1 (100-125)	N · m (lbf-in)	Non-lubricated threads
wt Approximate weight	71 (2.5)	g (oz)	
Case style	DO-205AA (DO-8) (IR B-15)		JEDEC

\*JEDEC registered values.

② Min. TC = -65°C for 1N3292B only.

④ I2t for time tx = I2√t · √tx.

③ Applies to 1N3292B.

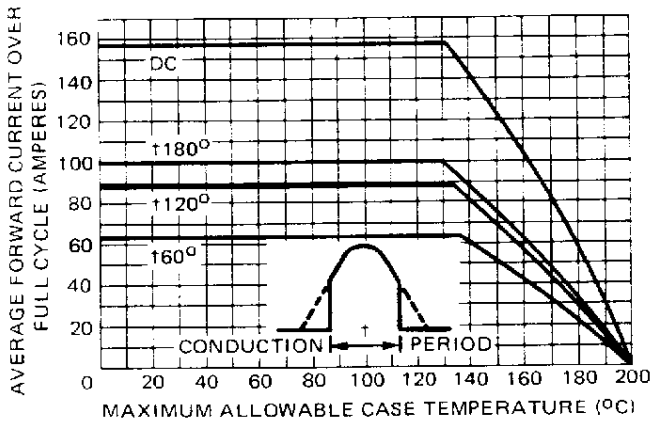

**Fig. 1 – Average Forward Current Vs Case Temperature (Sinusoidal Current Waveform)**

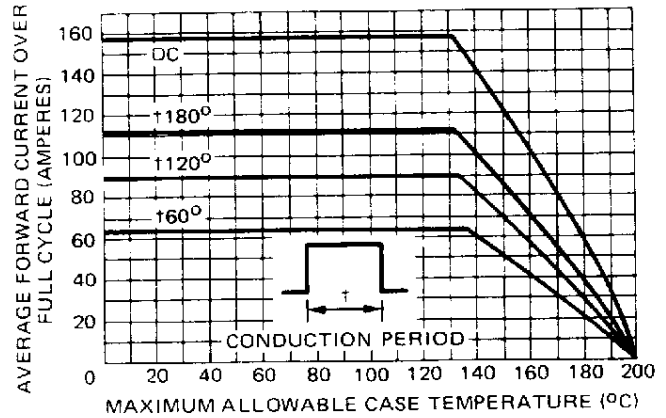

**Fig. 2 – Average Forward Current Vs Case Temperature (Rectangular Current Waveform)**

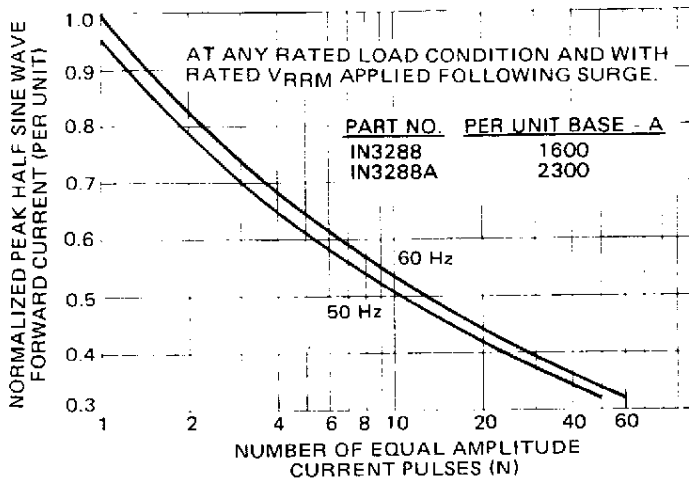

**Fig. 3 – Maximum Non-Repetitive Normalized Surge Current Vs. Number of Current Pulses**

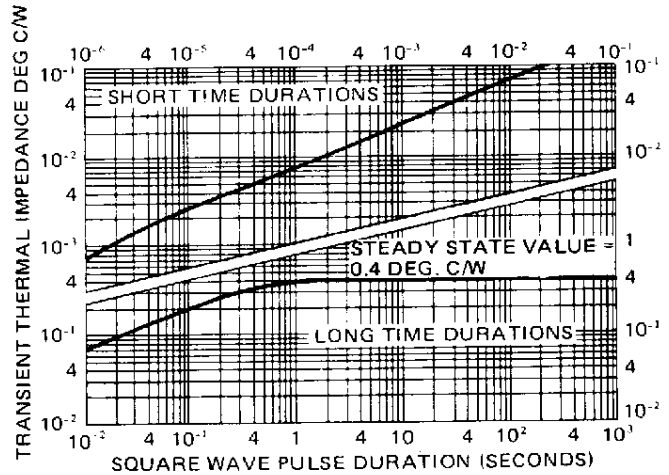

**Fig. 4 – Maximum Transient Thermal Impedance, Junction-to-Case, Vs. Pulse Duration**

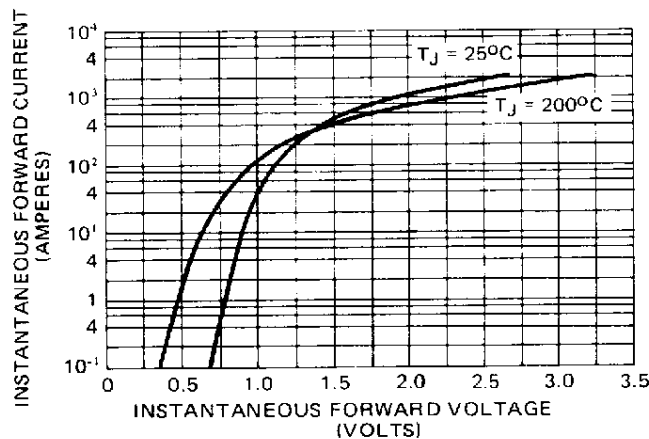

**Fig. 5 – Maximum Forward Voltage Vs Forward Current**

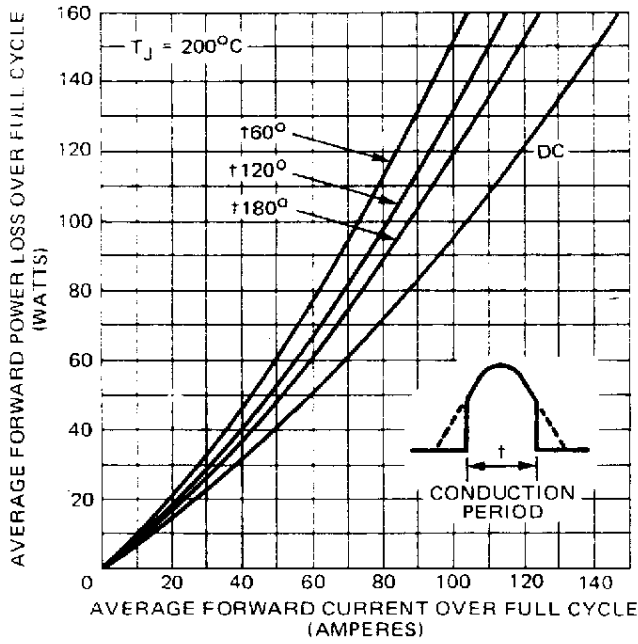

Fig. 6 — Maximum Forward Power Loss Vs Low Level Forward Current (Sinusoidal Current Waveform)

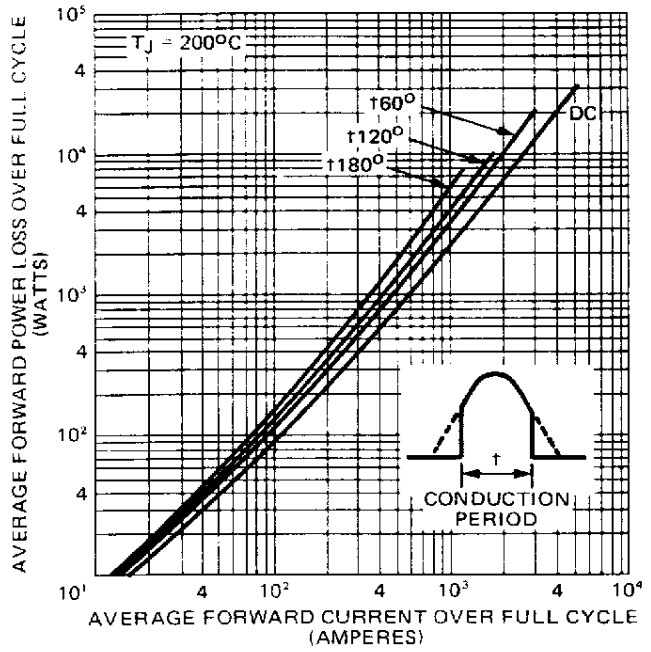

Fig. 7 — Maximum Forward Power Loss Vs High Level Forward Current (Sinusoidal Current Waveform)

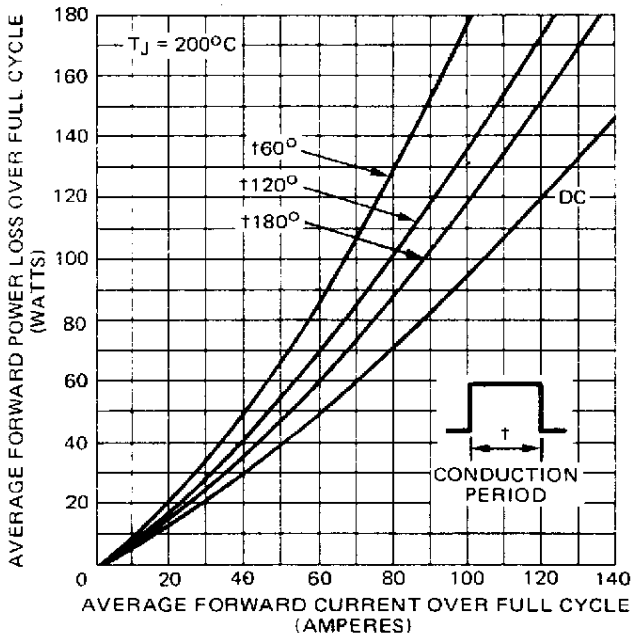

Fig. 8 — Maximum Forward Power Loss Vs High Level Forward Current (Rectangular Current Waveform)

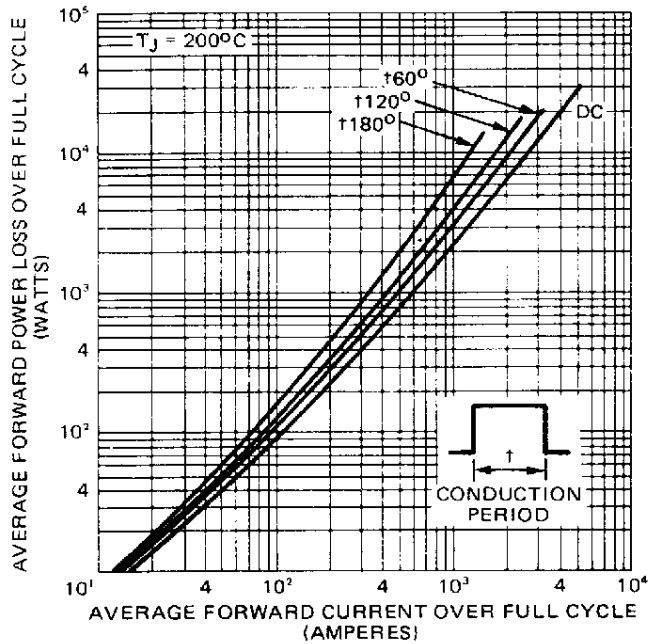

Fig. 9 — Maximum Forward Power Loss Vs High Level Forward Current (Rectangular Current Waveform)



Printed on Signet recycled offset:  
made from 50% recycled waste paper, including  
10% de-inked, post-consumer waste.



**International**  
**IOR Rectifier**

**WORLD HEADQUARTERS:** 233 Kansas St., El Segundo, California 90245, Tel: (310) 322-3331, Twx: 4720403  
**EUROPEAN HEADQUARTERS:** Hurst Green, Oxted, Surrey RH8 9BB England, Tel: (0883) 713215, Twx: 95219

**IR CANADA:** 101 Bentley St., Markham, Ontario L3R 3L1, Tel: (416) 475-1897. **IR GERMANY:** Saalburgstrasse 157, D-6380 Bad Homburg, Tel: 6172-37066. **IR ITALY:** Via Liguria 49  
10071 Borgaro, Torino, Tel: (011) 470 1484. **IR FAR EAST:** K&H Building, 30-4 Nishiikebukuro 3-Chome, Toshima-ku, Tokyo 171 Japan, Tel: (03) 983 0641. **IR SOUTHEAST ASIA:**  
190 Middle Road, HEX 10-01 Fortune Centre, Singapore 0718, Tel: (65) 336 3922.

**Sales Offices, Agents and Distributors in Major Cities Throughout the World.**

Printed in U.S.A. 3/94 5m

*Data and specifications subject to change without notice. (1082)*